



*z/OS*

Resource  
Measurement Facility  
Reference Summary

## Second Edition, October 2001

This is a major revision of SX33-9033-00.

This edition applies to Version 1 Release 2 of z/OS (5694-A01) and to all subsequent releases and modifications until otherwise indicated in new editions.

Order publications through your IBM representative or the IBM branch office serving your locality. Publications are not stocked at the address below.

IBM welcomes your comments. A form for readers' comments may be provided at the back of this publication, or you may address your comments to the following address:

IBM DEUTSCHLAND ENTWICKLUNG GMBH  
eSERVER PERFORMANCE MANAGEMENT DEVELOPMENT  
SCHOENAICHER STRASSE 220  
71032 BOEBLINGEN, GERMANY

If you prefer to send comments electronically, use one of the following methods:

FAX (RMF Development): Your International Access  
Code +49+7031+16+4240  
Internet: [rmf@de.ibm.com](mailto:rmf@de.ibm.com)

### Internet

<http://www.ibm.com/servers/eserver/zseries/zos/rmf/>

If you would like a reply, be sure to include your name, address, telephone number, or FAX number.

When you send information to IBM, you grant IBM a nonexclusive right to use or distribute the information in any way it believes appropriate without incurring any obligation to you.

© Copyright International Business Machines Corporation 1988, 2001. All rights reserved.

US Government Users Restricted Rights – Use, duplication or disclosure restricted by GSA ADP Schedule Contract with IBM Corp.

---

# Contents

<b>Preface</b> . . . . .	<b>v</b>
<b>Chapter 1. Gathering Reference</b> . . . . .	<b>1-1</b>
To Start, Stop and Control Sessions . . . . .	1-1
Monitor I Session Options . . . . .	1-3
Time-frame Options . . . . .	1-7
Reporting Options . . . . .	1-8
Environment Options . . . . .	1-9
Monitor III Session Options . . . . .	1-9
<b>Chapter 2. Reporting Reference</b> . . . . .	<b>2-1</b>
To Start RMF in ISPF or TSO/E . . . . .	2-1
Monitor II Display and Background Session . . . . .	2-2
Report Commands and Options . . . . .	2-2
Display Session Commands . . . . .	2-10
Background Session Options . . . . .	2-12
Monitor III Reporter Session . . . . .	2-14
Session Commands . . . . .	2-14
Report Commands . . . . .	2-16
<b>Notices</b> . . . . .	<b>A-1</b>



---

## Preface

The RMF Reference Summary provides a quick reference to:

- Operator commands
- Monitor I session options
- Monitor II background session options
- Monitor II display commands
- Monitor III gatherer session options
- Monitor III reporter session commands

For detailed information about using RMF Monitors, see *RMF User's Guide*.

### How to read the diagrams

To read a syntax diagram, follow the path of the line, starting from left to right and moving from top to bottom.

- The **▶▶—** symbol indicates the beginning of a syntax diagram.
- The **—▶** symbol, at the end of a line, indicates that the syntax diagram continues on the next line.
- The **▶—** symbol, at the beginning of a line, indicates that a syntax diagram continues from the previous line.
- The **—▶◀** symbol indicates the end of a syntax diagram.

Syntax items (for example, a keyword or variable) may be:

- Directly on the line (required)
- Above the line (default)
- Below the line (optional)

### Symbols

You **must** code these symbols exactly as they appear in the syntax diagram

- # Number sign
- :
- ,
- = Equal Sign
- Hyphen

- ( ) Parenthesis
- .

**Variables**

Highlighted lowercase letters denote variable information that you must substitute with specific information.

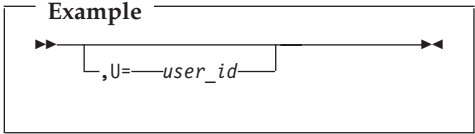

Here you must code U= as shown and supply an ID for user\_id. You may, of course, enter U in lowercase, but you must not change it otherwise.

**Repetition**

An arrow returning to the left means that the item can be repeated.

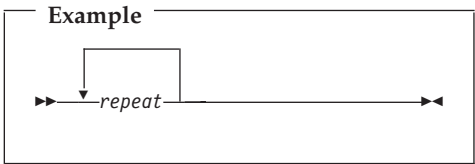

A character within the arrow means you must separate repeated items with that character.

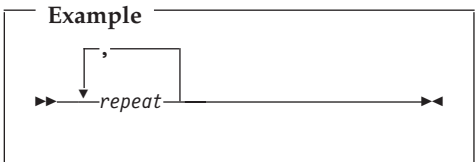

A footnote (1) by the arrow references a limit that tells how many times the item can be repeated.

**Example**

**Notes:**

- 1 Specify *repeat* up to 5 times.

**Defaults**

Defaults are above the line. The system uses the default unless you override it. You can override the default by coding an option from the stack below the line.

**Example**

In this example, A is the default. You can override A by choosing B or C.

**Required Choices**

When two or more items are in a stack and one of them is on the line, you **must** specify one item.

**Example**

Here you must enter either A or B or C.

**Optional Choice**

When an item is below the line, the item is optional. Only one item **may** be chosen.

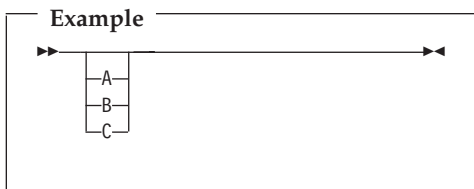

Here you may enter either A or B or C, or you may omit the field.



---

## Chapter 1. Gathering Reference

This chapter contains a summary of the operator commands, the Monitor I session options, and the Monitor III session options.

---

### To Start, Stop and Control Sessions

Three system commands, four session commands, and numerous display commands control RMF processing. The syntax for system and session commands is as follows; see chapters on specific RMF sessions in *RMF User's Guide*, for detailed descriptions and examples.

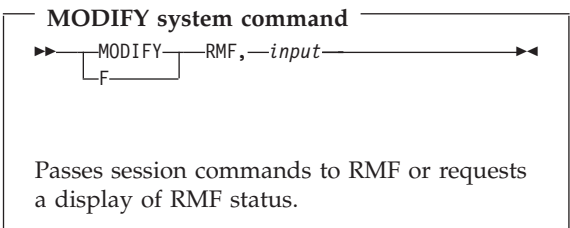
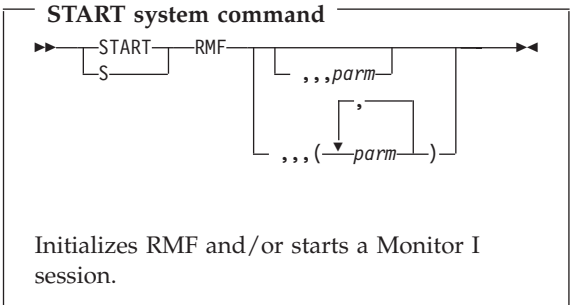

The following session commands are passed to RMF through the input field of the system MODIFY command.

### START session command

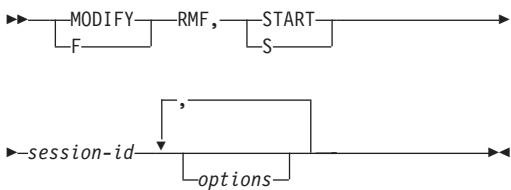

Starts an RMF session.

### MODIFY session command

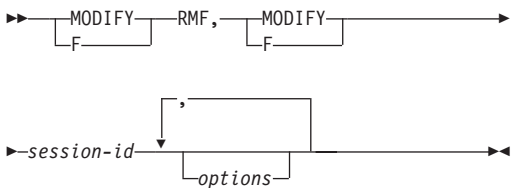

Changes options currently in effect.

### STOP session command

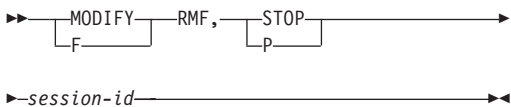

Ends processing of a specified session.

### DISPLAY session command

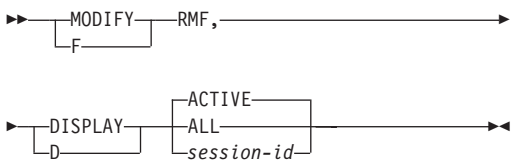

Displays status information for active non-TSO/E RMF sessions.



where:

**parm**

Options for a Monitor I session (specify NOZZ if you do not want to start a Monitor I session concurrently with RMF initialization). Options have the form:

option[(value)]

**input**

Any session command (START, STOP, MODIFY, or DISPLAY).

**session-id**

Session identifier for a particular session. The session identifier is one of the following:

- ZZ** Monitor I session
- cc** Monitor II background session (any two characters except ZZ)
- III** Monitor III data gatherer session

**options**

Session options to be changed. Each option has the form

option[(value)]

and must be separated by a comma.

**ACTIVE**

Session identifiers of all active non-TSO/E sessions are to be displayed.

**ALL**

Session identifiers and current options of all active non-TSO/E sessions are to be displayed.

## Monitor I Session Options

You can specify Monitor I session options in:

- The **parm** field of the START command
- The PARM field of the EXEC statement in a cataloged procedure

- The RMF Monitor I Parmlib member ERBRMF00

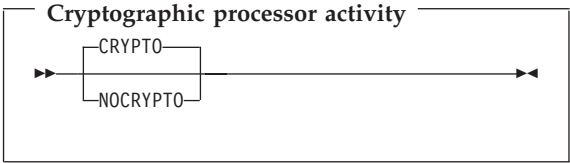
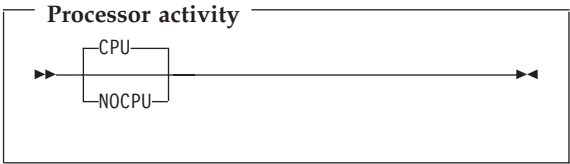
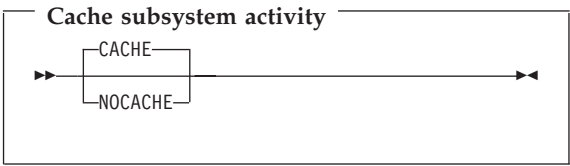

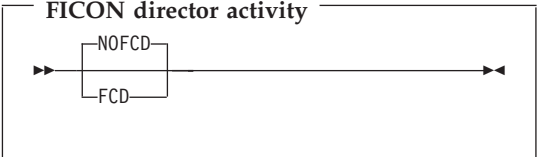
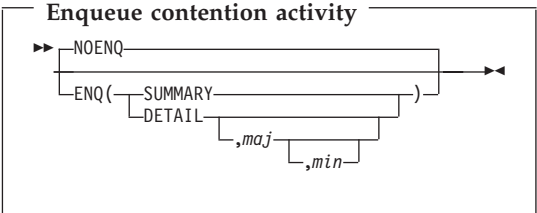
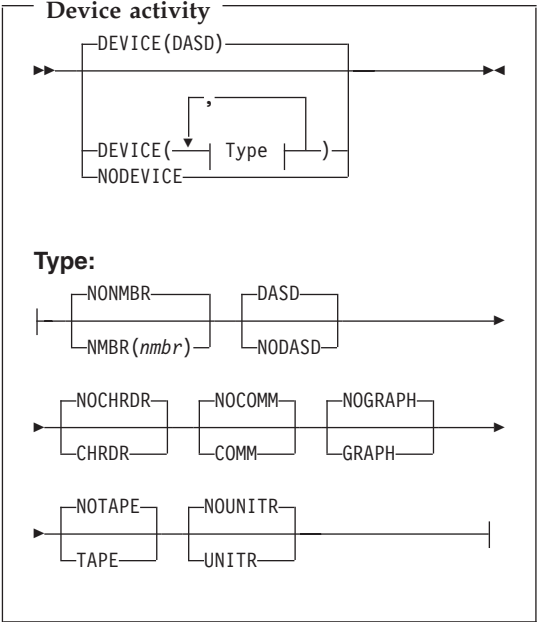

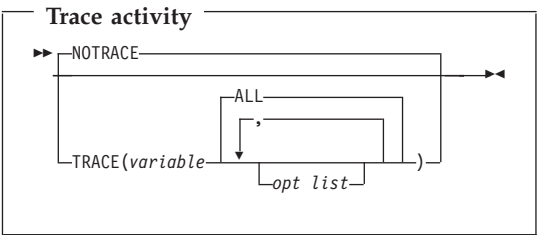
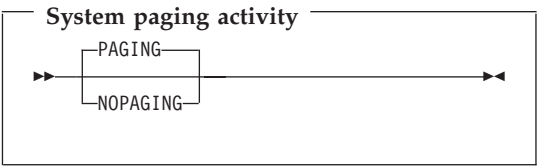
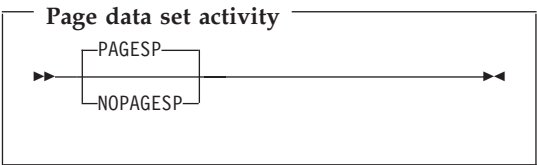
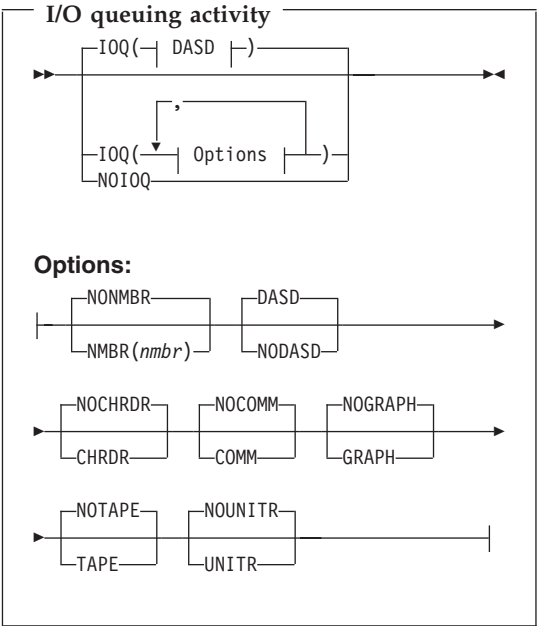

### Virtual storage activity

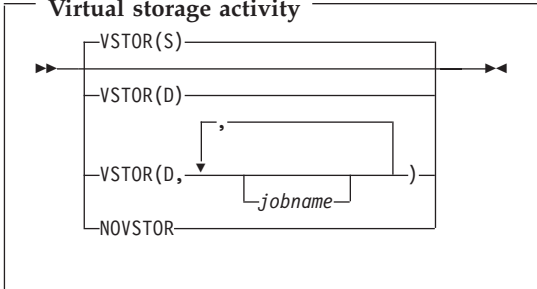

### Workload activity

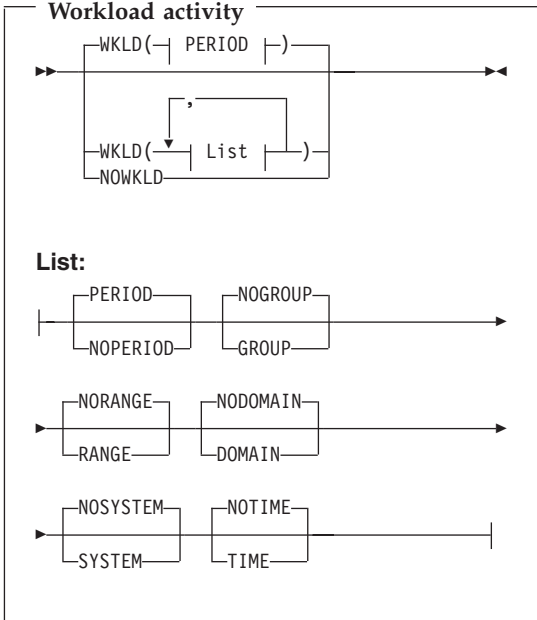

## Time-frame Options

### Cycle length

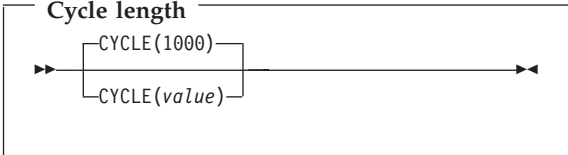

### Report interval length

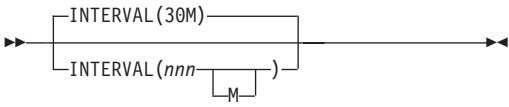

### Duration of session

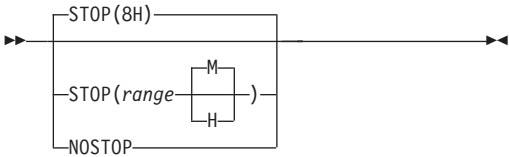

### Interval synchronization

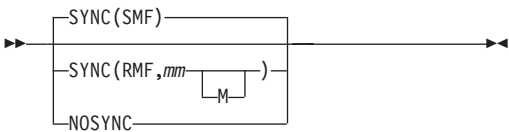

## Reporting Options

### Option list

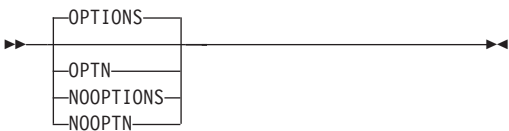

### Write SMF record





### Print interval reports

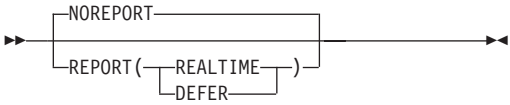

### Class for printed reports

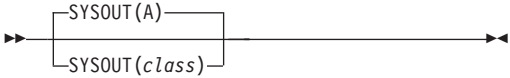

## Environment Options

### User exit



### Parmlib member

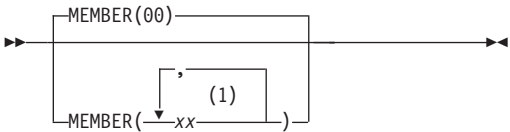

#### Notes:

- 1 Up to five members can be specified.

## Monitor III Session Options

### Cache subsystem activity

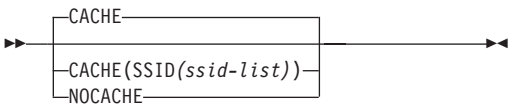

Specifies measurements for cache subsystem activity.

### Coupling facility details



Specifies whether detailed data gathering for the activities in the coupling facility should be performed.

### Gatherer cycle



Specifies, in milliseconds, the length of a cycle. Valid range is 50 to 9999.

### Data set support

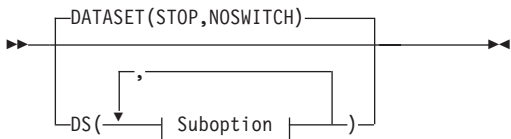

#### Suboption:

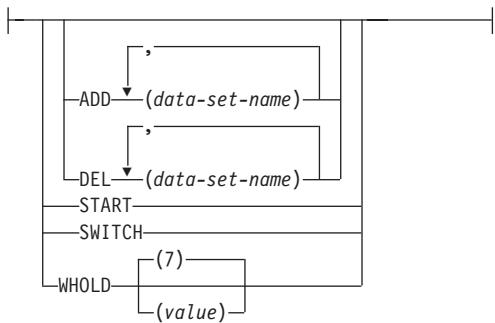

Controls the recording of samples to user-defined data sets.

### Hierarchical file system activity

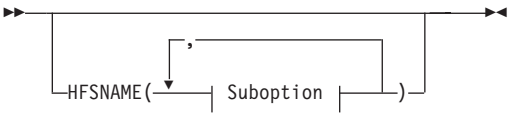

### Suboption:

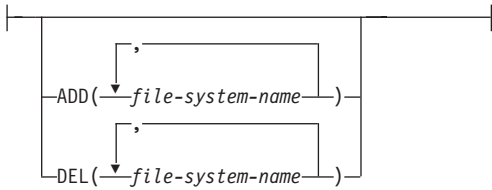

Specifies data recording of statistics for UNIX HFS names.

### I/O subsystem activity



Specifies data recording for I/O subsystem and channel path activity.

### Member

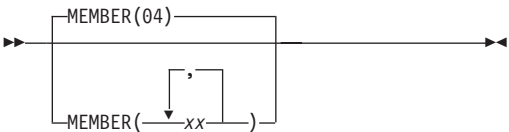

Specifies the members of a partitioned data set that contain the options to be used for the session.

### Mintime

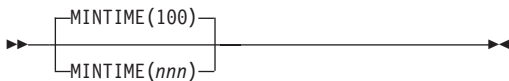

Specifies interval length in seconds. Valid range is 10 to 999.

### OMVS process data



Specifies measurements for OMVS process data.

### Print list of options



Specifies if options are to be displayed at operator console.

### Resource

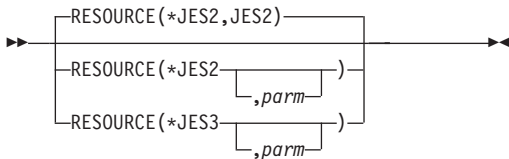

Specifies the job entry subsystem resource where *parm* is the given name if other than JES2 or JES3.

### Duration of session

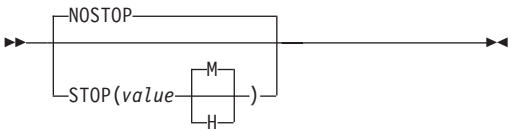

Specifies the duration of the session in minutes (M) or hours (H). Valid range is 1 minute to 168 hours.

### Synchronous write SMF

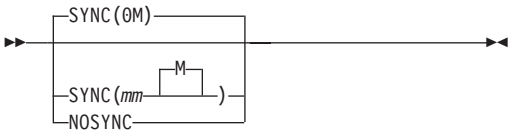

Synchronizes interval time with the hour where mm is the number of minutes after the hour at which synchronization will occur.

### Sysout

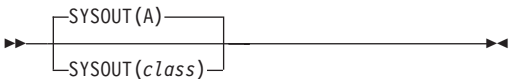

Specifies the output class for session messages.

### VSAM RLS activity

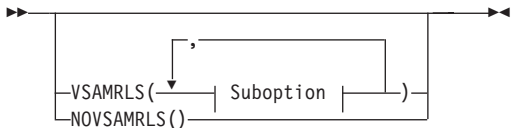

### Suboption:

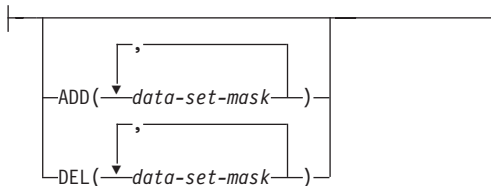

Controls the collection of VSAM RLS activity data.

### Storage buffer



Specifies in megabytes, the maximum storage buffer size. Valid range is 4 to 999 megabytes.

---

## Chapter 2. Reporting Reference

This chapter contains a summary of the commands used in a reporting session.

---

### To Start RMF in ISPF or TSO/E

To start RMF and display the RMF Performance Management menu, enter:

```
Start RMF
▶▶—RMF—◀◀
```

To bypass the RMF Performance Management Menu, enter the RMF command with the appropriate option:

```
Start RMF Monitor

To call the Postprocessor, enter:
▶▶—RMF PP—◀◀

To call Monitor II, enter:
▶▶—RMF MON2—◀◀

To call Monitor III, enter:
▶▶—RMF MON3—◀◀

To call the Monitor III Utility, enter:
▶▶—RMF UTIL—◀◀
```

```
Start RMF Monitor II

You can also use the following command to
start Monitor II:
▶▶—RMFMON—◀◀
```

# Monitor II Display and Background Session

Use the display session syntax in an ISPF or TSO/E session to obtain snapshot reports of specific address spaces or system resources.

Use the background session syntax in a non-interactive session to create a printed report and SMF records.

## Report Commands and Options

The general format of a command to request a report is:

**General syntax**

Background session syntax:  
▶—*rep(options)*—▶

Display session syntax:  
▶—*rep—options*—▶

*rep* is the report name, and *options* are the options for the report.

For the legend, see page 2-9.

**AS resource data**

Background session syntax

Display session syntax



### AS resource data for job

Background session syntax

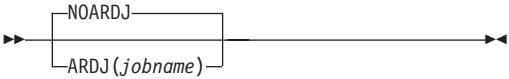

Display session syntax



### AS state data

Background session syntax

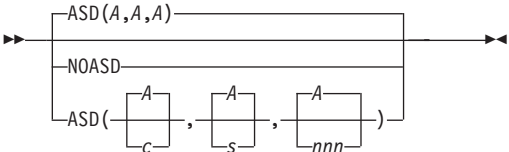

Display session syntax

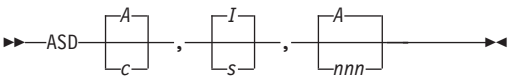

### AS state data for job

Background session syntax

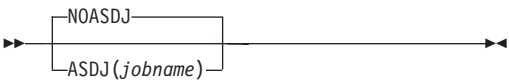

Display session syntax



### AS SRM data

Background session syntax

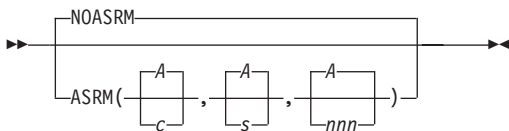

Display session syntax

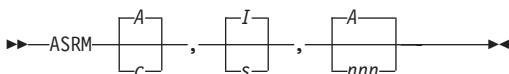

### AS SRM data for job

Background session syntax

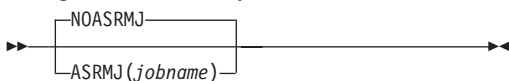

Display session syntax



### Channel path activity

Background session syntax



Display session syntax



### Domain activity

Background session syntax



Display session syntax



This option is accepted in compatibility mode only.

### Device activity

Background session syntax

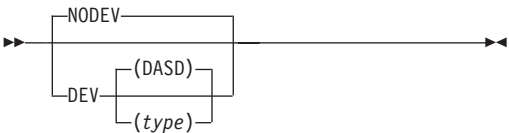

Display session syntax

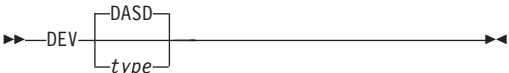

### Specific direct access device

Background session syntax

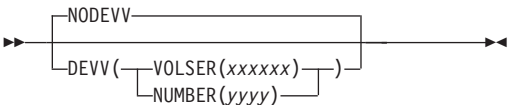

Display session syntax

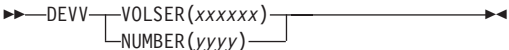

### HFS statistics

Display session syntax

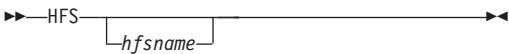

### IRLM long lock detection

Display session syntax



### I/O queuing

Background session syntax

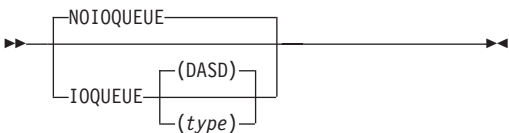

Display session syntax

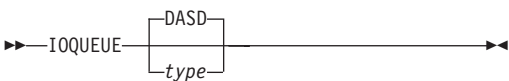

### Library lists

Display session syntax

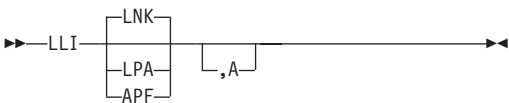

### Page/Swap data set activity

Background session syntax

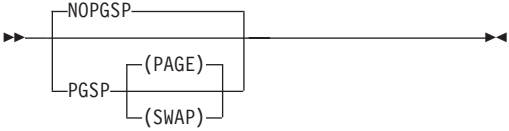

Display session syntax

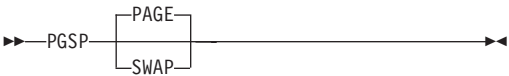

### Sysplex data server activity

Display session syntax



### Enqueue contention activity

Background session syntax

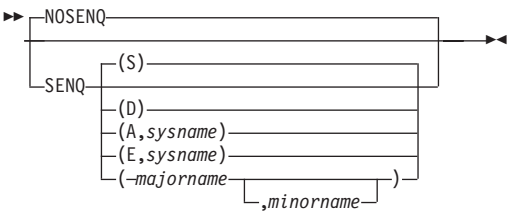

Display session syntax

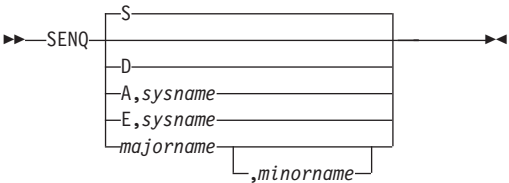

## Reserve activity

Background session syntax

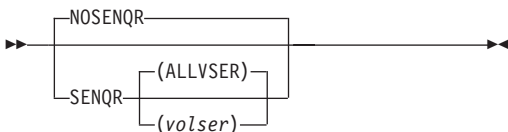

Display session syntax

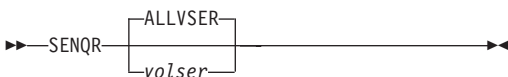

## System paging activity

Background session syntax

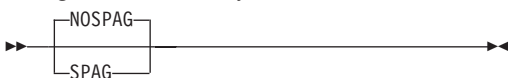

Display session syntax



## SRM activity

Background session syntax



Display session syntax



## Transaction activity

### Background session syntax

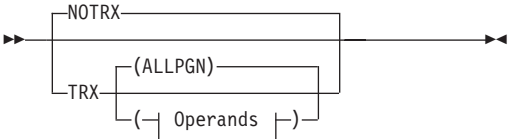

### Display session syntax



### Operands:

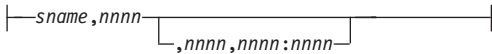

This option is available in compatibility mode only.

## User-specified activity

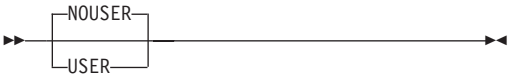

### Legend:

- c Class of the address spaces to be included; either A, B, T, AS, or O.
- s Status of the address spaces to be included; either A or I.
- d Domain of the address spaces to be included; either A or a domain number.

### hfsname

Name of an hierarchical file system.

### jobname

Specific job name.

### majormame[,minormame]

Name of resource or group of resource.

**nnnn**

1-4 digit performance group number.

**sname**

Subsystem name defined in the ICS definition.

**sysname**

Name of a specific system in a global resource serialization complex.

**type**

Either a device class, one or more volume serial numbers, one or more device numbers, or one or more SG names.

**volser**

Volume serial number.

## Display Session Commands

What session commands you use depends on whether you are working with the ISPF interface or the TSO interface. Some commands are valid in both environments.

For the legend, see page 2-13.

## TSO Commands

Scroll through a table report:

▶▶—F—▶▶

Display the list of reports on the display menu:

▶▶—M—▶▶

Display defaults:

▶▶—MM—▶▶

Print a report:

▶▶—P—▶▶

Request reports repeatedly:

▶▶—T—▶▶  
    ┌──10—,—4──┐  
    └──n—,—t──┘

where:

*n* is the number of times a report is repeated.

*t* is the number of seconds between reports

Stop the session:





Set PF key:



*rep* is a report name.

## ISPF Commands

Cancel the option dialog without saving changes:



List of Monitor II reporter commands:



Find a text string:



If your search string contains blanks, you must enclose it in quotes.

Refresh a report after an interval:



where:

*nnn* is the number of seconds between refreshes. Valid values are between 1 and 3600s.

End GO mode by pressing the ATTN or PA1 key.

Print a report:



Reset all optional values on the option dialog to their defaults:



Repeat a previously entered Find command:

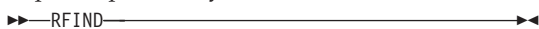



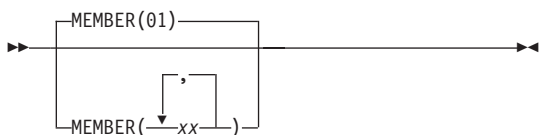

**Note:** You can specify up to five members.

Print list of options:



Write SMF data set:



Print interval reports:

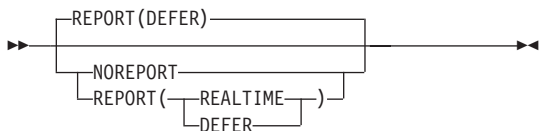

Duration of Monitor II session:

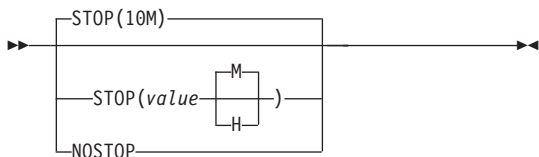

Class for printed reports:



Number of seconds in interval:

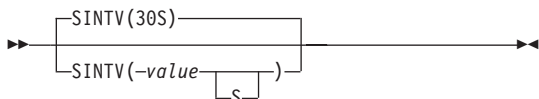

where:

**class**

is a SYSOUT class

**value**

is a 1-5 digit number that specifies time in either minutes (M) or hours (H)

**AS** address space

---

**Monitor III Reporter Session**

To start a Monitor III session, from TSO or ISPF, enter:

```
►► RMF MON3 ◀◀
```

**Session Commands**

Backward/forward referencing:

```
►► BREF ◀◀  
    FREF ◀◀
```

```
► D T R S ◀◀
```

**D:**

```
| DATE = mm . dd . yy |  
| D / / |
```

**T:**

```
| TIME = hh : mm : ss |  
| T : : |
```

**R:**

```
| RANGE = |  
| R nnnM S |  
| nnnn |
```

**S:**

```
| SYSTEM = systemname |  
| S |
```

Restore options to original values:

```
►► CANCEL ◀◀
```

Display RMF commands help panel:

```
►► COMMANDS ◀◀
```

Display data from current range:

▶▶—CURRENT—▶▶

Search for character string:

▶▶—FIND—*string*—▶▶

Start GO mode:

▶▶—GO—▶▶

Switch graphic mode on or off:

▶▶—GRAPHIC—

ON
OFF

—▶▶

Print hardcopy reports and screens:

▶▶—HARDCOPY—

ON
OFF
SCREEN
REPORT

—▶▶

Start an Interactive Chart Utility session:

▶▶—ICU—▶▶

Display listing of PF keys:

▶▶—PFK—▶▶

Reset options to RMF defaults:

▶▶—RESET—▶▶

Display last command entered:

▶▶—RETRIEVE—▶▶

Repeat FIND command:

▶▶—RFIND—▶▶

Switch between tabular and graphic mode:

▶▶—TABULAR—

ON
OFF

—▶▶

Switch between tabular and graphic mode:

▶▶—TOGGLE—▶▶

## Commands to Request Menus and Option Panels

Display Color Graphic Options panel:

▶▶—COLOR—▶▶

Display Job Report panel:

▶▶—JOBS—▶▶

Display Language Options panel:

▶▶—LANGUAGE—▶▶

Display Options panel:

▶▶—OPTIONS—▶▶

Display Option Set panel:

▶▶—OPTSET—▶▶

Display Overview Report menu:

▶▶—OVERVIEW—▶▶

Display Report Options panel of current report:

▶▶—ROPTIONS—▶▶

Display Resource Report menu:

▶▶—RESOURCE—▶▶

Display Session Options panel:

▶▶—SESSION—▶▶

Display Subsystem Report menu:

▶▶—SUBS—▶▶

Display Sysplex Report menu:

▶▶—SYSPLEX—▶▶

Display User-written Report menu:

▶▶—USER—▶▶

## Report Commands

Reports can be requested from the command line or from the Primary menu.

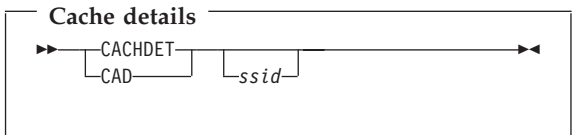

### Cache summary



### Coupling facility activity



### Coupling facility overview

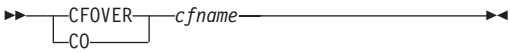

### Coupling facility systems

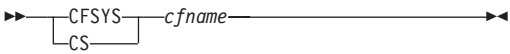

### Channel path activity

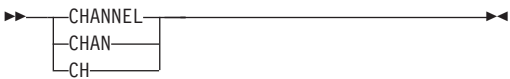

### CPC capacity



## Delays

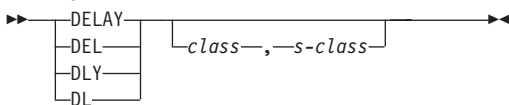

You can specify a class and a selection separated by a comma.

## Job variation of delay

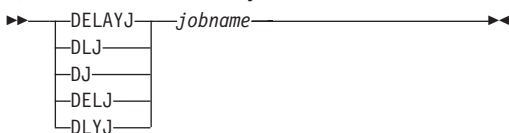

## Device delays

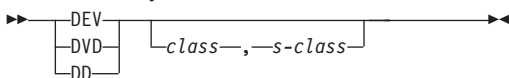

## Device delays - Job report

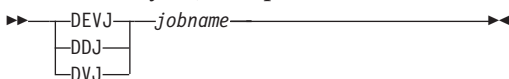

## Device delays for resources

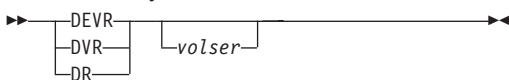



### Data index



### Data set delays



### Data set delays - Job report

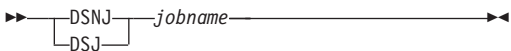

### Data set delays - Volume report

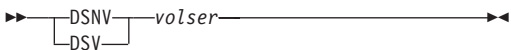

### Enclave activity

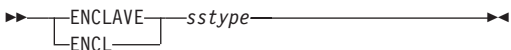

### Enqueue delays

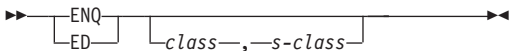

### Enqueue delays - Job report

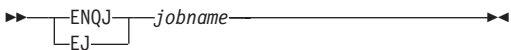

### Resource delays

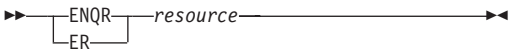

### Group response time

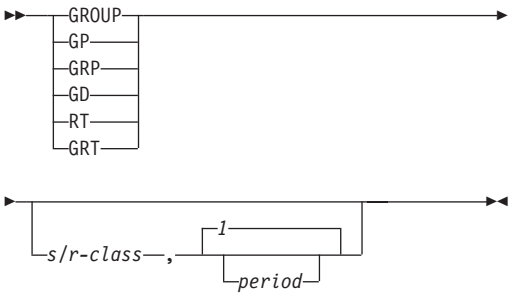

### HSM delays

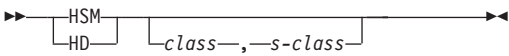

### HSM delays - Job report

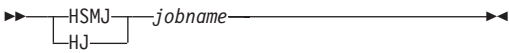

### I/O queuing activity



### JES delays

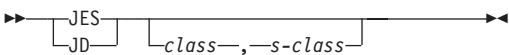

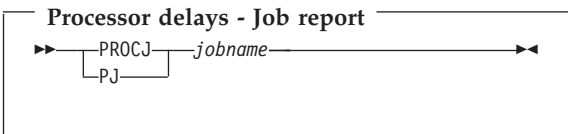
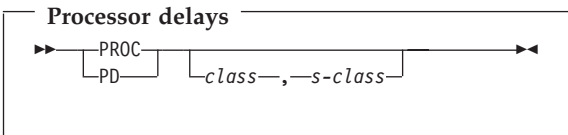
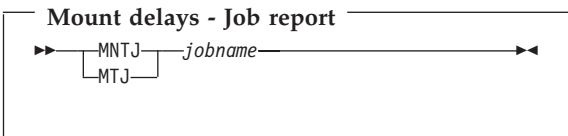
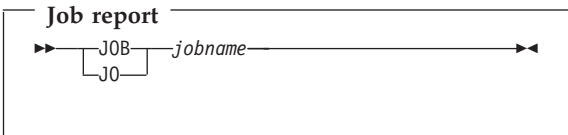

### Quiesce delays - Job report

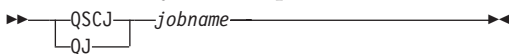

### VSAM RLS activity by data set

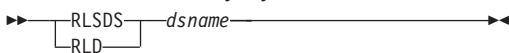

### VSAM LRU statistics

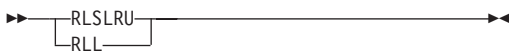

### VSAM RLS activity by storage class

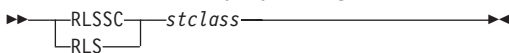

### Storage delays

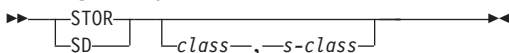

### Common storage information

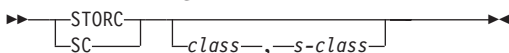

### Common storage remaining



### Frame count information

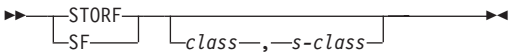

### Storage delays - Job report

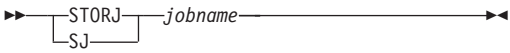

### Information on storage use



### Summarized storage information



### Sysplex-wide enqueue delays

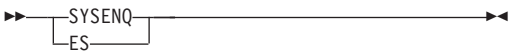

### Overview of system workload

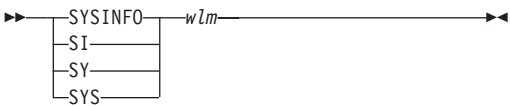

### Response time distribution

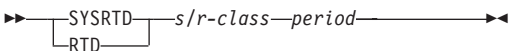

### Performance summary - Sysplex

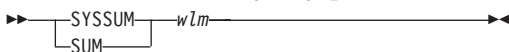

### Work manager - Sysplex

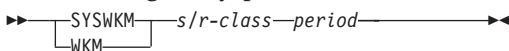

### Overview of system activity



### XCF delays

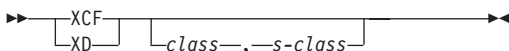

### XCF delays - Job report

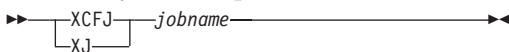

where:

- cfname** Name of a coupling facility.
- class** Either All (A), Batch (B), TSO (T), STC (S), ASCH (AS), or O (OMVS). For DELAY, you can also specify E for enclaves.
- dsname** Name of a data set.
- jobname** Name of job to be reported.
- period** Service or report class period.
- resource** Name of resource to be reported.
- s-class** Service class name.

<b>s/r-class</b>	Service or report class name.
<b>ssid</b>	Cache subsystem identifier.
<b>sstype</b>	Name of a subsystem that schedules enclaves.
<b>stclass</b>	Storage class name.
<b>volser</b>	Volume serial number.
<b>wlm</b>	Name of a workload group,
	service class, or report class.
<b>Note:</b>	For systems running in compatibility mode,
	the terms s-class, s/r-class, and wlm have to
	be replaced by DMNnnn (domain) or PGnnn
	(performance group).





---

## Notices

This information was developed for products and services offered in the U.S.A.

IBM may not offer the products, services, or features discussed in this document in other countries. Consult your local IBM representative for information on the products and services currently available in your area. Any reference to an IBM product, program, or service is not intended to state or imply that only that IBM product, program, or service may be used. Any functionally equivalent product, program, or service that does not infringe any IBM intellectual property right may be used instead. However, it is the user's responsibility to evaluate and verify the operation of any non-IBM product, program, or service.

IBM may have patents or pending patent applications covering subject matter described in this document. The furnishing of this document does not give you any license to these patents. You can send license inquiries, in writing, to:

IBM Director of Licensing  
IBM Corporation  
North Castle Drive  
Armonk, NY 10504-1785  
U.S.A.

Licensees of this program who wish to have information about it for the purpose of enabling: (i) the exchange of information between independently created programs and other programs (including this one) and (ii) the mutual use of the information which has been exchanged, should contact:

IBM Corporation  
Mail Station P300  
2455 South Road  
Poughkeepsie New York 12601-5400  
U.S.A.

Such information may be available, subject to appropriate terms and conditions, including in some cases, payment of a fee.

The licensed program described in this document and all licensed material available for it are provided by IBM under terms of the IBM Customer Agreement, IBM International Program License Agreement or any equivalent agreement between us.

For license inquiries regarding double-byte (DBCS) information, contact the IBM Intellectual Property Department in your country or send inquiries, in writing, to:

IBM World Trade Asia Corporation  
Licensing  
2-31 Roppongi 3-chome, Minato-ku  
Tokyo 106, Japan

The following paragraph does not apply to the United Kingdom or any other country where such provisions are inconsistent with local law:  
INTERNATIONAL BUSINESS MACHINES CORPORATION PROVIDES THIS PUBLICATION "AS IS" WITHOUT WARRANTY OF ANY KIND, EITHER EXPRESS OR IMPLIED, INCLUDING, BUT NOT LIMITED TO, THE IMPLIED WARRANTIES OF NON-INFRINGEMENT, MERCHANTABILITY OR FITNESS FOR A PARTICULAR PURPOSE. Some states do not allow disclaimer of express or implied warranties in certain transactions, therefore, this statement may not apply to you.

This information could include technical inaccuracies or typographical errors. Changes are periodically made to the information herein; these changes will be incorporated in new editions of the publication. IBM may make improvements and/or changes in the product(s) and/or the program(s) described in this publication at any time without notice.

Any references in this information to non-IBM Web sites are provided for convenience only and do not in any manner serve as an endorsement of those Web sites. The materials at those Web sites are not part of the materials for this IBM product and use of those Web sites is at your own risk.

If you are viewing this information softcopy, the photographs and color illustrations may not appear.





Program Number: 5694-A01



Printed in the United States of America  
on recycled paper containing 10%  
recovered post-consumer fiber.

SX33-9033-01

