

z/OS



DFSMSrmm Command Reference Summary

z/OS



DFSMSrmm Command Reference Summary

Second Edition, March 2002

This edition applies to Version 1 Release 3 of z/OS™ (5694-A01) and to all subsequent releases and modifications until otherwise indicated in new editions.

This edition replaces SX26-6022-00.

Order publications through your IBM representative or the IBM branch office serving your locality. Publications are not stocked at the address below.

IBM welcomes your comments. A form for readers' comments may be provided at the back of this publication, or you may address your comments to the following address:

International Business Machines Corporation
RCF Processing, Department M86/050
5600 Cottle Road
San Jose, CA 95193-0001
United States of America

IBMLINK from US: STARPUBS at SJEVM5
IBMLINK from Canada: STARPUBS at TORIBM
IBM Mail Exchange: USIB3VVD at IBMMAIL
Internet: starpubs@us.ibm.com
World Wide Web: <http://www.storage.ibm.com/software/sms/sms/home.htm>

If you would like a reply, be sure to include your name, address, telephone number, or FAX number.

Make sure to include the following in your comment or note:

- Title and order number of this book
- Page number or topic related to your comment

When you send information to IBM, you grant IBM a nonexclusive right to use or distribute the information in any way it believes appropriate without incurring any obligation to you.

© **Copyright International Business Machines Corporation 1992, 2002. All rights reserved.**

US Government Users Restricted Rights – Use, duplication or disclosure restricted by GSA ADP Schedule Contract with IBM Corp.

Contents

About This Book	v
Notational Conventions	v
How to Read Syntax Diagrams	v
How to Abbreviate Commands and Operands.	vii
How to Use Continuation Characters	vii
Delimiters	viii
Character Sets	viii
Accessing z/OS DFSMS Books on the Internet	ix
DFSMSrmm TSO Subcommands	1
ADDBIN: Adding a Bin Number in a Storage Location	1
ADDDATASET: Adding Data Set Information	2
ADDOWNER: Adding Owner Information	3
ADDPRODUCT: Adding Software Product Information	3
ADDRACK: Adding a Shelf Location	4
ADDVOLUME: Adding Volume Information	5
Adding Volume Information (Cont.)	5
Non-SCRATCH Volume Optional Operands	7
ADDVRS: Adding a Vital Record Specification	9
ADDVRS: Adding a Data Set Vital Record Specification	9
ADDVRS: Adding a Location Name Vital Record Specification	10
ADDVRS: Adding a Retention Name Vital Record Specification	11
ADDVRS: Adding a Volume Vital Record Specification	13
CHANGEDATASET: Changing Data Set Information	14
CHANGEOWNER: Changing Owner Information	16
CHANGEPRODUCT: Changing Software Product Information.	17
CHANGEVOLUME: Changing Volume Information	18
CHANGEVOLUME: Confirm release and Global Movement Operands	18
CHANGEVOLUME: Specific Volume Optional Operands.	19
DELETEBIN: Deleting Bin Number Information	23
DELETEDATASET: Deleting Data Set Information	23
DELETEOWNER: Deleting Owner Information	23
DELETEPRODUCT: Deleting Software Product Information	23
DELETERACK: Deleting Shelf Location Information	24
DELETEVOLUME: Deleting Volume Information.	25
DELETEVRS: Deleting Vital Record Specification Information.	25
GETVOLUME: Requesting and Assigning Scratch Volumes	26
LISTBIN: Displaying Information about a Shelf Location	27
LISTCONTROL: Displaying Parmlib Options and Control Information	27
LISTDATASET: Displaying Information about a Data Set.	27
LISTOWNER: Displaying Information about an Owner	27
LISTPRODUCT: Displaying Information about a Software Product	28
LISTRACK: Displaying Information about a Shelf Location	28
LISTVOLUME: Displaying Information about a Volume	28
LISTVRS: Displaying Information about a Vital Record Specification	29
SEARCHBIN: Creating a List of Bin Numbers	30
SEARCHDATASET: Creating a List of Data Sets	31
SEARCHPRODUCT: Creating a List of Software Products	32
SEARCHRACK: Creating a List of Shelf Locations.	33
SEARCHVOLUME: Creating a List of Volumes	34
SEARCHVOLUME: Optional Operands	35
SEARCHVOLUME: Optional Operands (Cont.)	35
SEARCHVRS: Creating a List of Vital Record Specifications	37

Appendix. Accessibility	39
Using assistive technologies	39
Keyboard navigation of the user interface	39
Notices	41
Programming Interface Information	42
Trademarks	42

About This Book

This book is a summary of the RMM TSO subcommand and its operands intended for tape librarians, storage administrators, operators, and system programmers responsible for handling and managing removable media. It is also intended for general users who use removable media.

Notational Conventions

This section explains the notational conventions used in this book.

How to Read Syntax Diagrams

Throughout this library, diagrams are used to illustrate the programming syntax. Keyword parameters are parameters that follow the positional parameters. Unless otherwise stated, keyword parameters can be coded in any order. The following list tells you how to interpret the syntax diagrams:

- Read the diagrams from left-to-right, top-to-bottom, following the main path line. Each diagram begins on the left with double arrowheads and ends on the right with two arrowheads facing each other.

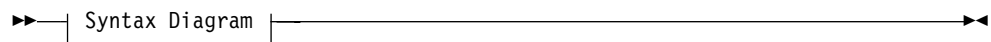

- If a diagram is longer than one line, each line to be continued ends with a single arrowhead and the next line begins with a single arrowhead.

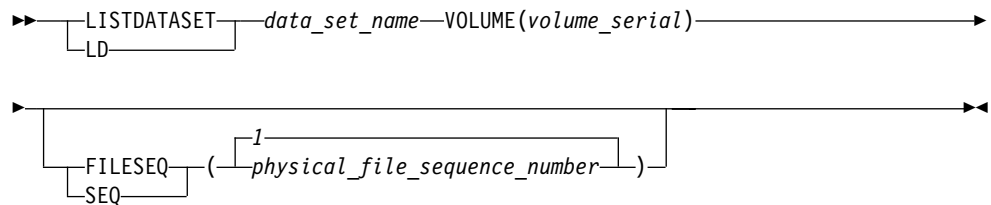

- Required keywords and values appear on the main path line. You must code required keywords and values.



If several mutually exclusive required keywords or values exist, they are stacked vertically in alphanumeric order.

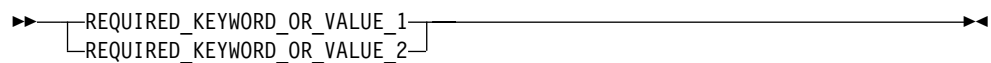

- Optional keywords and values appear below the main path line. You can choose not to code optional keywords and values.

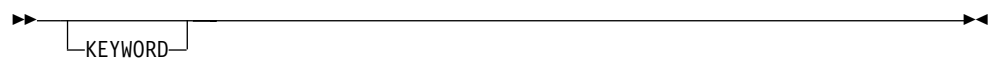

If several mutually exclusive optional keywords or values exist, they are stacked vertically in alphanumeric order below the main path line.

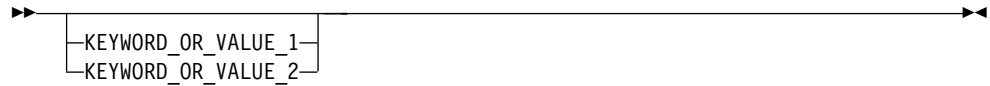

- An arrow returning to the left above a keyword or value on the main path line means that the keyword or value can be repeated. The comma means that each keyword or value must be separated from the next by a comma.



- An arrow returning to the left above a group of keywords or values means more than one can be selected, or a single one can be repeated.

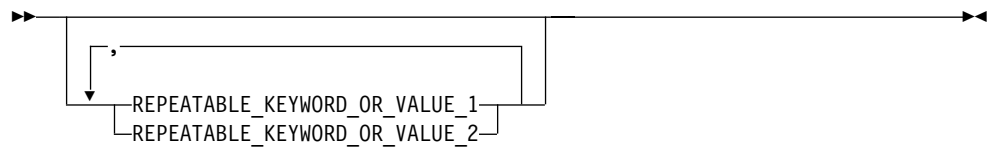

- A word in all uppercase is a keyword or value you must spell exactly as shown. In this example, you must code **KEYWORD**.

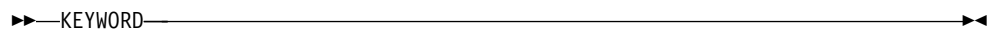

If a keyword or value can be abbreviated, the abbreviation is discussed in the text associated with the syntax diagram.

- If a diagram shows a character that is not alphanumeric (such as parentheses, periods, commas, and equal signs), you must code the character as part of the syntax. In this example, you must code **KEYWORD=(001,0.001)**.

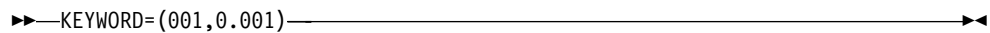

- If a diagram shows a blank space, you must code the blank space as part of the syntax. In this example, you must code **KEYWORD=(001 FIXED)**.



- Default keywords and values appear above the main path line. If you omit the keyword or value entirely, the default is used.



- A word in all lowercase italics is a *variable*. Where you see a variable in the syntax, you must replace it with one of its allowable names or values, as defined in the text.



- References to syntax notes appear as numbers enclosed in parentheses above the line. Do not code the parentheses or the number.

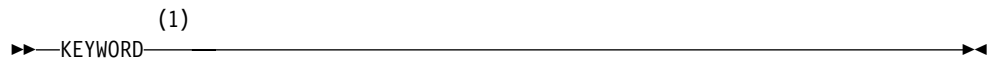

Notes:

- 1 An example of a syntax note.
- Some diagrams contain *syntax fragments*, which serve to break up diagrams that are too long, too complex, or too repetitious. Syntax fragment names are in mixed case and are shown in the diagram and in the heading of the fragment. The fragment is placed below the main diagram.

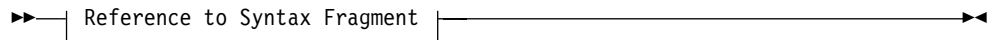

Syntax Fragment:



Figure 1 shows an example of a syntax diagram.

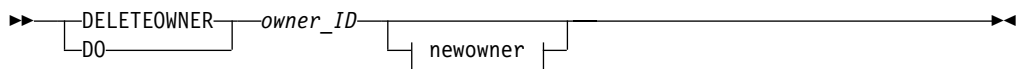

newowner



Notes:

- 1 Must be specified if the owner owns one or more volumes.

Figure 1. Example of the DFSMSrmm DELETEDOWNER TSO Subcommand Syntax Diagram

The possible valid versions of the RMM DELETEDOWNER command are:

```
RMM DELETEDOWNER owner
RMM DO owner
RMM DELETEDOWNER owner NEWOWNER(new_owner)
RMM DO owner NEWOWNER(new_owner)
```

How to Abbreviate Commands and Operands

The TSO abbreviation convention applies for all DFSMSrmm commands and operands. The TSO abbreviation convention requires you to specify as much of the command name or operand as is necessary to distinguish it from the other command names or operands.

Some DFSMSrmm keyword operands allow unique abbreviations. All unique abbreviations are shown in the command syntax diagrams.

How to Use Continuation Characters

The symbol - is used as the continuation character in this book. You can use either - or +.

- Do not ignore leading blanks on the continuation statement

- + Ignore leading blanks on the continuation statement

Delimiters

When you type a command, you must separate the command name from the first operand by one or more blanks. You must separate operands by one or more blanks or a comma. Do not use a semicolon as a delimiter because any character you enter after a semicolon is ignored.

Character Sets

To code job control statements, use characters from the character sets in Table 1. Table 2 lists the special characters that have syntactical functions in job control statements.

Table 1. Character Sets

Character Set	Contents	
Alphanumeric	Alphabetic Numeric	Capital A through Z 0 through 9
National (See note)	“At” sign Dollar sign Pound sign	@ (Characters that can be \$ represented by hexadecimal # values X'7C', X'5B', and X'7B')
Special	Comma Period Slash Apostrophe Left parenthesis Right parenthesis Asterisk Ampersand Plus sign Hyphen Equal sign Blank	, . / ' () * & + - =
EBCDIC text	EBCDIC printable character set	Characters that can be represented by hexadecimal X'40' through X'FE'
<p>Note: The system recognizes the following hexadecimal representations of the U.S. National characters; @ as X'7C'; \$ as X'5B'; and # as X'7B'. In countries other than the U.S., the U.S. National characters represented on terminal keyboards might generate a different hexadecimal representation and cause an error. For example, in some countries the \$ character may generate a X'4A'.</p>		

Table 2. Special Characters Used in Syntax

Character	Syntactical Function
,	To separate parameters and subparameters
=	To separate a keyword from its value, for example, BURST=YES
(b)	To enclose subparameter list or the member name of a PDS or PDSE
&	To identify a symbolic parameter, for example, &LIB
&&	To identify a temporary data set name, for example, &&TEMPDS, and, to identify an in-stream or sysout data set name, for example, &&PAYOUT
.	To separate parts of a qualified data set name, for example, A.B.C., or parts of certain parameters or subparameters, for example, nodename.userid

Table 2. Special Characters Used in Syntax (continued)

Character	Syntactical Function
*	To refer to an earlier statement, for example, OUTPUT=*.name, or, in certain statements, to indicate special functions: //label CNTL * //ddname DD * RESTART=* on the JOB statement
'	To enclose specified parameter values which contain special characters
(blank)	To delimit fields

Accessing z/OS DFSMS Books on the Internet

In addition to making softcopy books available on CD-ROM, IBM provides access to unlicensed z/OS softcopy books on the Internet. To find z/OS books on the Internet, first go to the z/OS home page: <http://www.ibm.com/servers/eserver/zseries/zos>

From this Web site, you can link directly to the z/OS softcopy books by selecting the Library icon. You can also link to IBM Direct to order hardcopy books.

DFSMSrmm TSO Subcommands

The IBM® tape management product DFSMSrmm™ provides the RMM TSO subcommand and a set of subcommands to request DFSMSrmm functions.

ADDBIN: Adding a Bin Number in a Storage Location

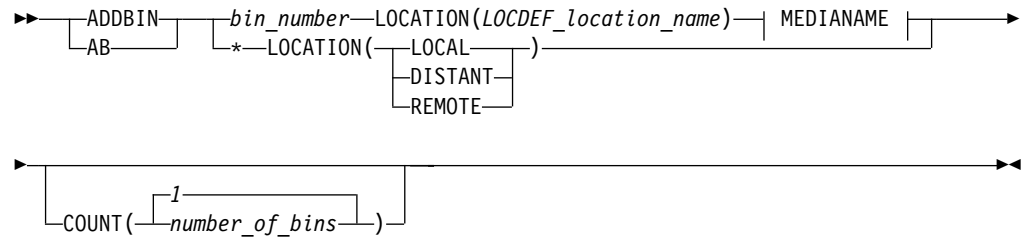

MEDIANAME:

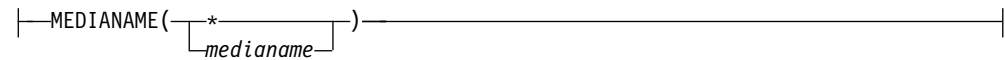

ADDDATASET: Adding Data Set Information

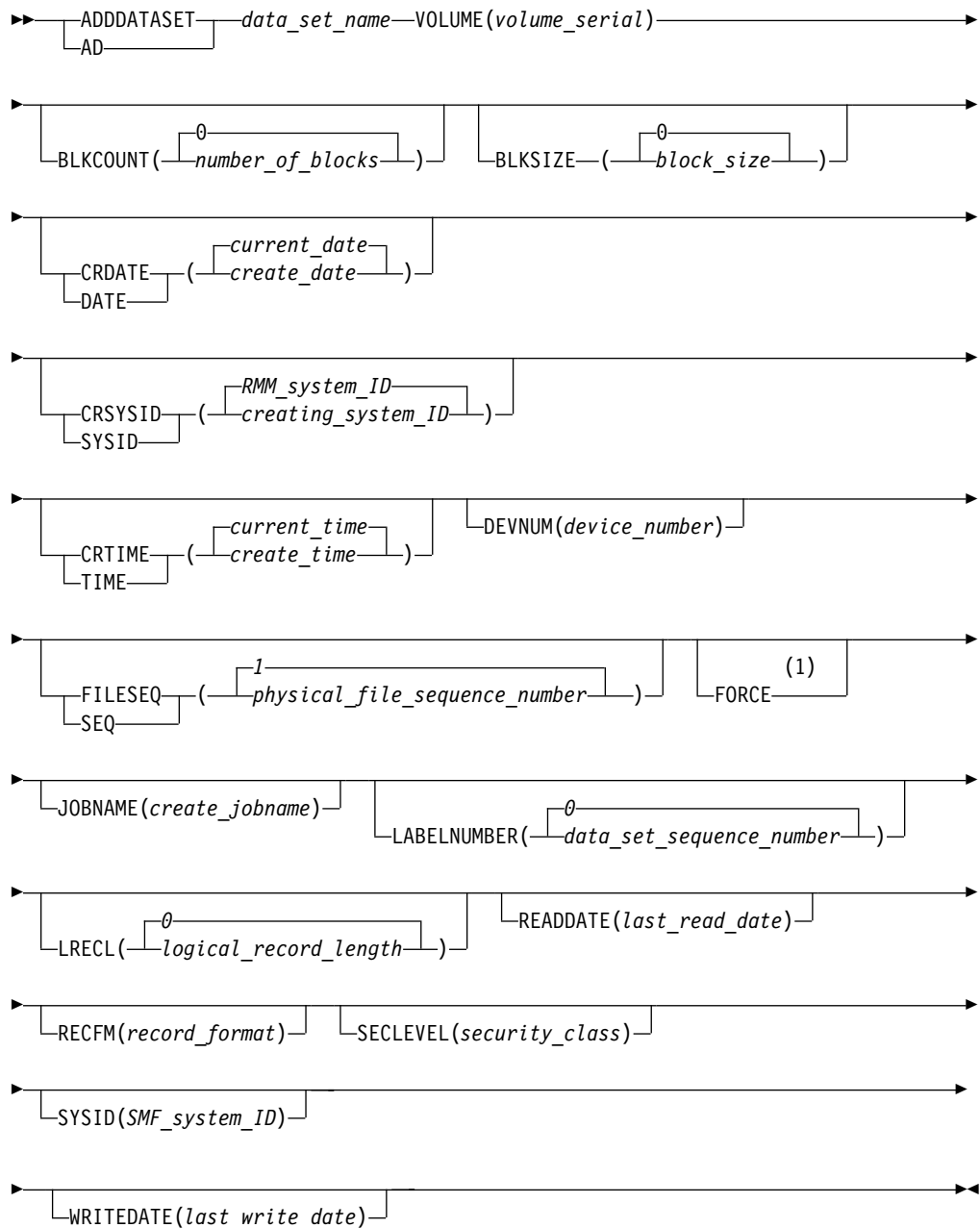

Notes:

- 1 Specify the FORCE operand to add a data set to a volume where information was recorded by DFSMSrmm during O/C/EOV processing. You must have CONTROL access to the STGADMIN.EDG.MASTER security resource and UPDATE access to the STGADMIN.EDG.FORCE security resource to use the FORCE operand.

ADDOWNER: Adding Owner Information

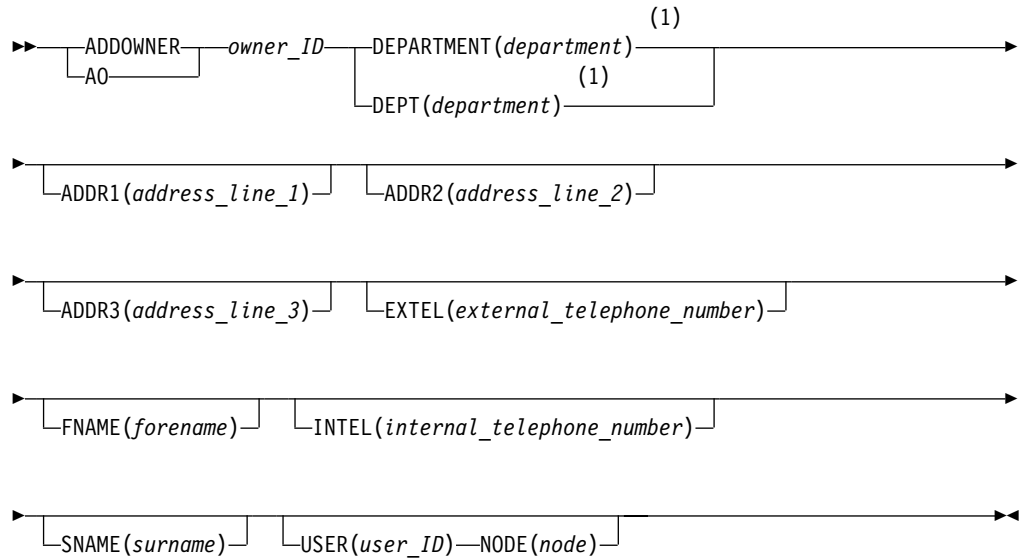

Notes:

- 1 The DEPARTMENT operand must contain at least one non-blank character.

ADDPRODUCT: Adding Software Product Information

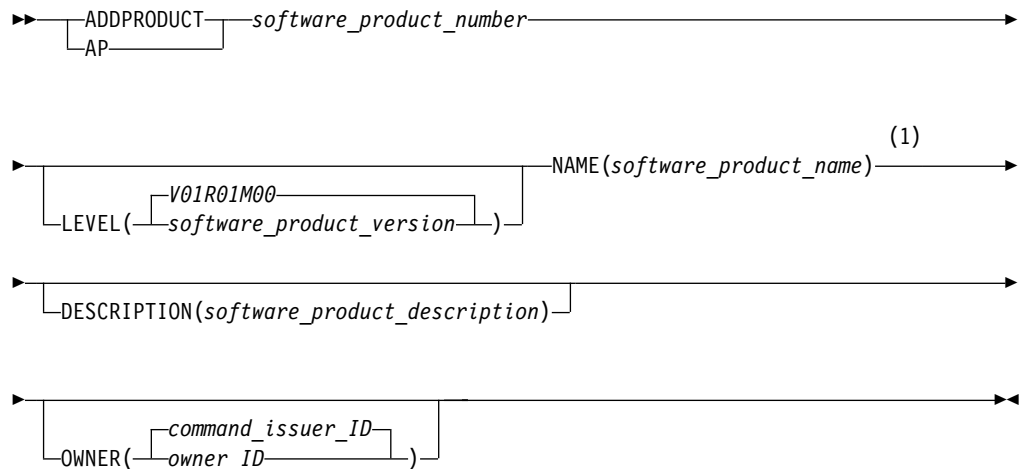

Notes:

- 1 The NAME operand must contain at least one non-blank character.

ADDRACK: Adding a Shelf Location

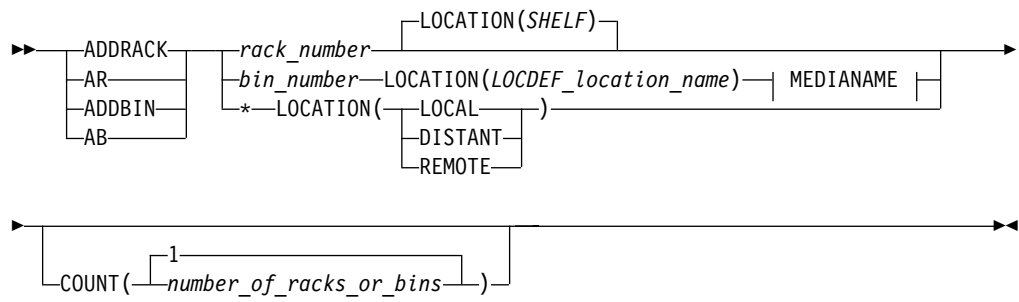

MEDIANAME:

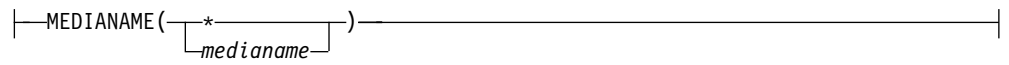

ADDVOLUME: Adding Volume Information

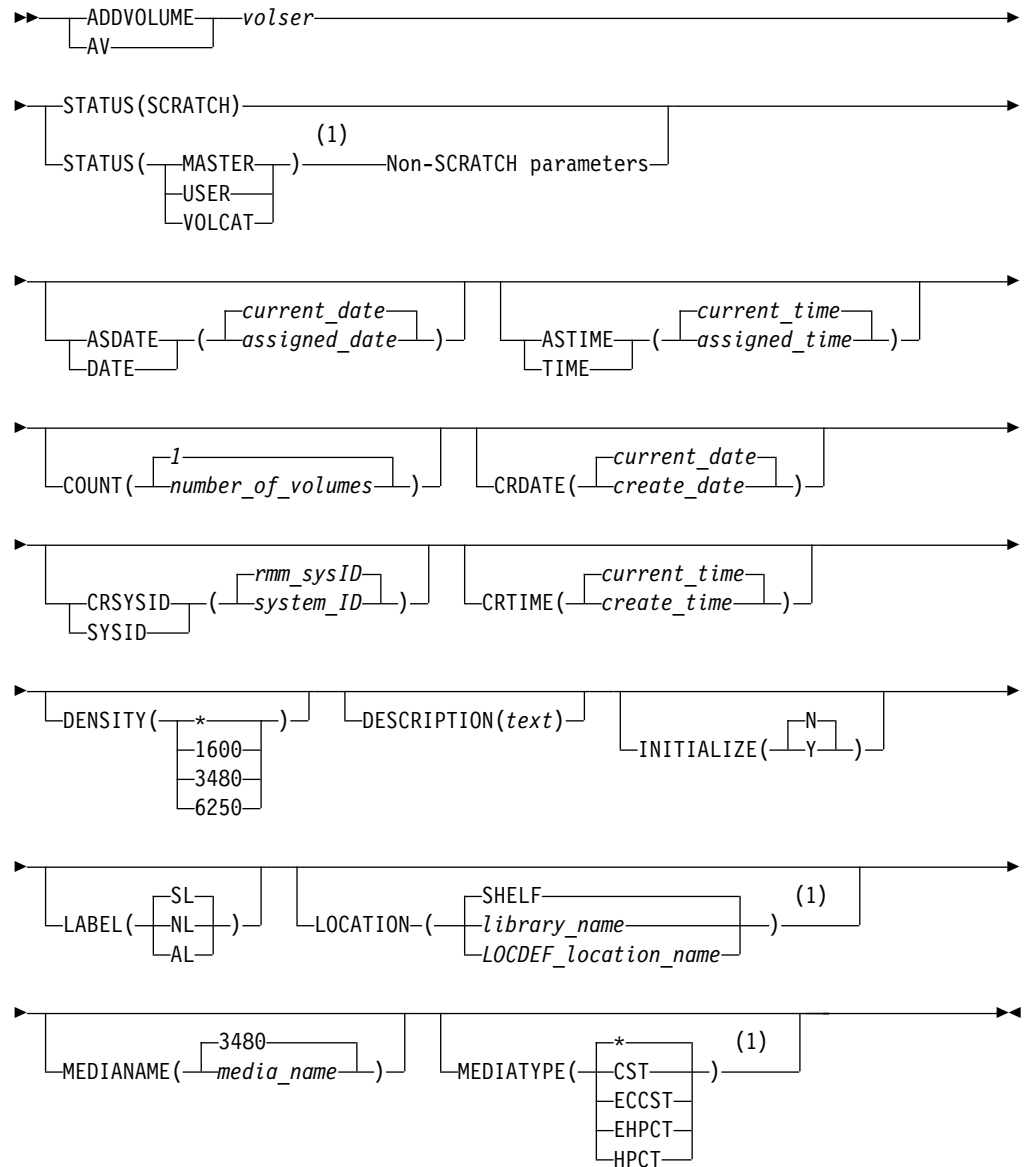

Notes:

- 1 This operand uses the tape configuration database information when STATUS(VOLCAT) is specified.

Adding Volume Information (Cont.)

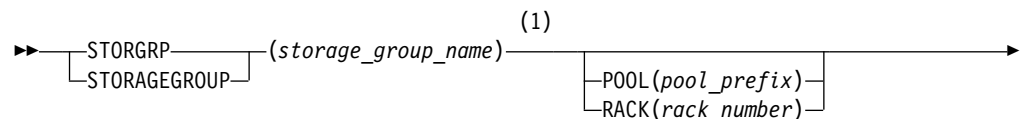

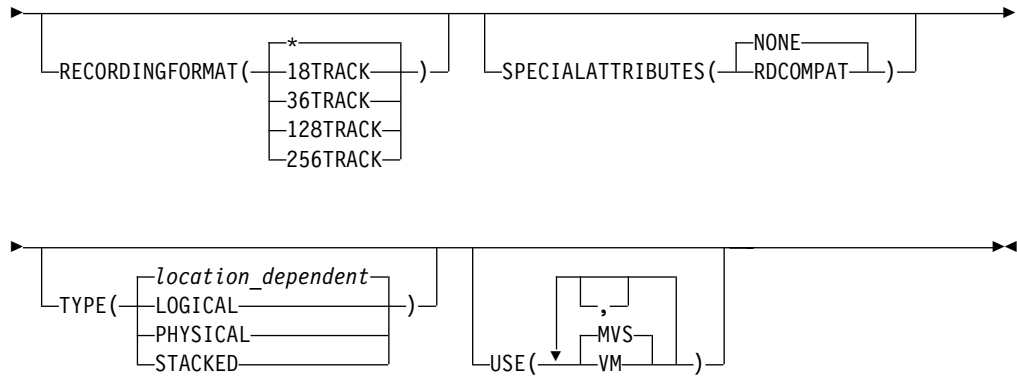

Notes:

- 1 This operand uses the tape configuration database information when STATUS(VOLCAT) is specified.

Non-SCRATCH Volume Optional Operands

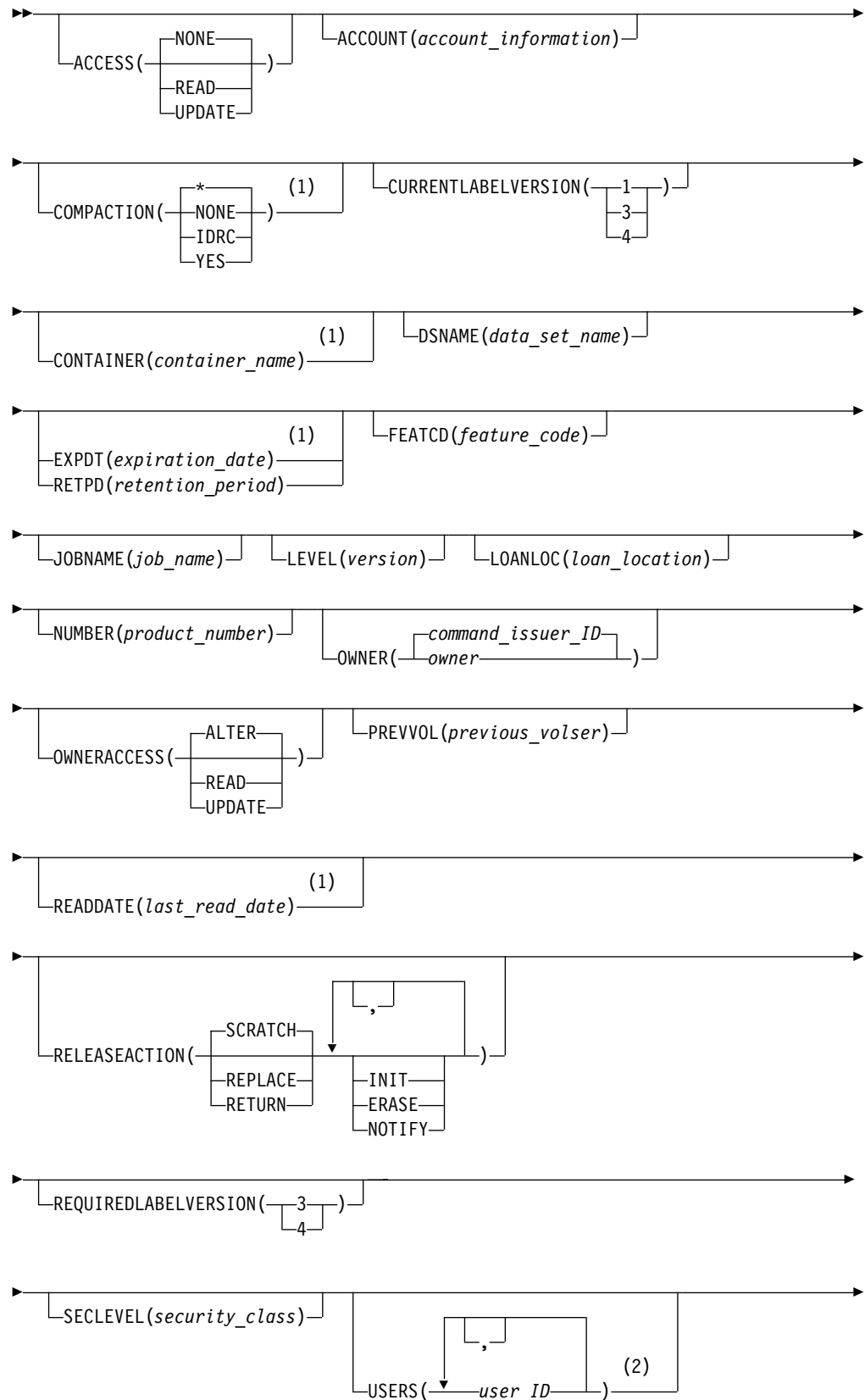

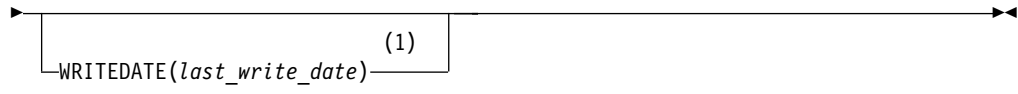

Notes:

- 1 This operand uses the tape configuration database information when STATUS(VOLCAT) is specified.
- 2 You can specify a maximum of 12 user IDs.

ADDVRS: Adding a Vital Record Specification

ADDVRS: Adding a Data Set Vital Record Specification

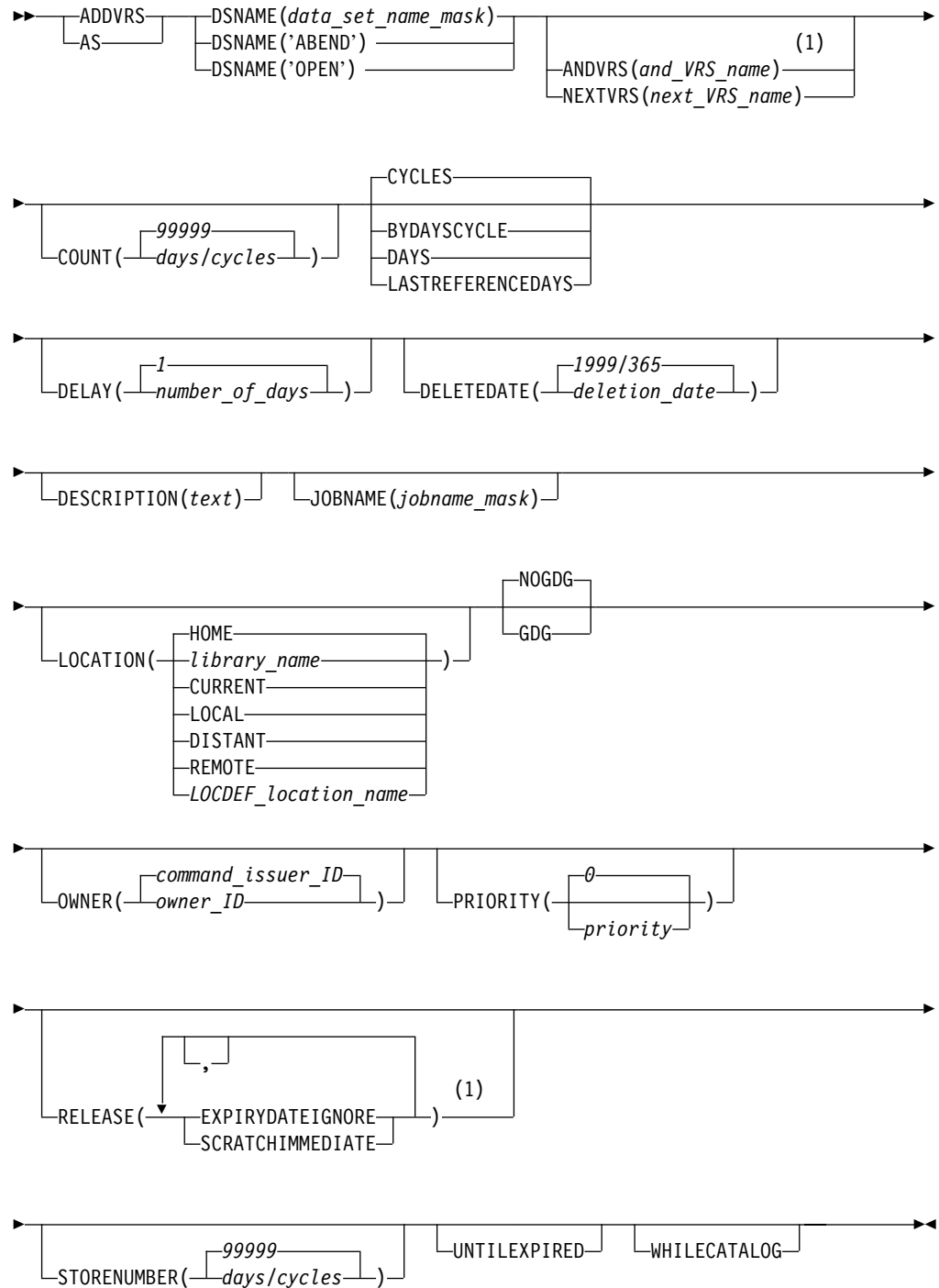

Notes:

- 1 This operand is honored when you specify the DFSMSrmm parmlib OPTION VRSEL(NEW) operand.

ADDVRS: Adding a Location Name Vital Record Specification

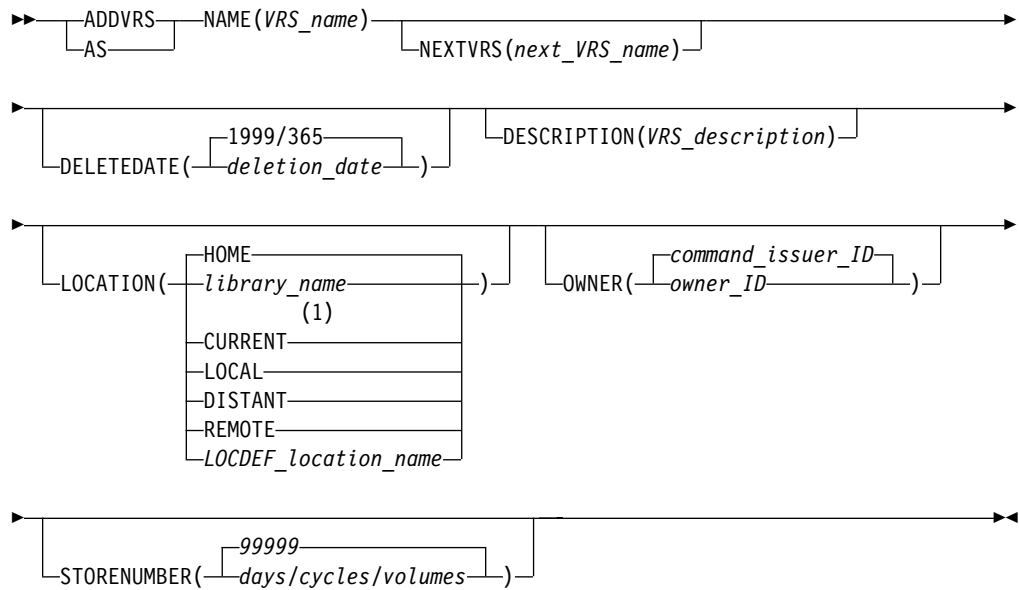

Notes:

- 1 This operand is honored when you specify the DFSMSrmm parmlib OPTION VRSEL(NEW) operand.

ADDVRS: Adding a Retention Name Vital Record Specification

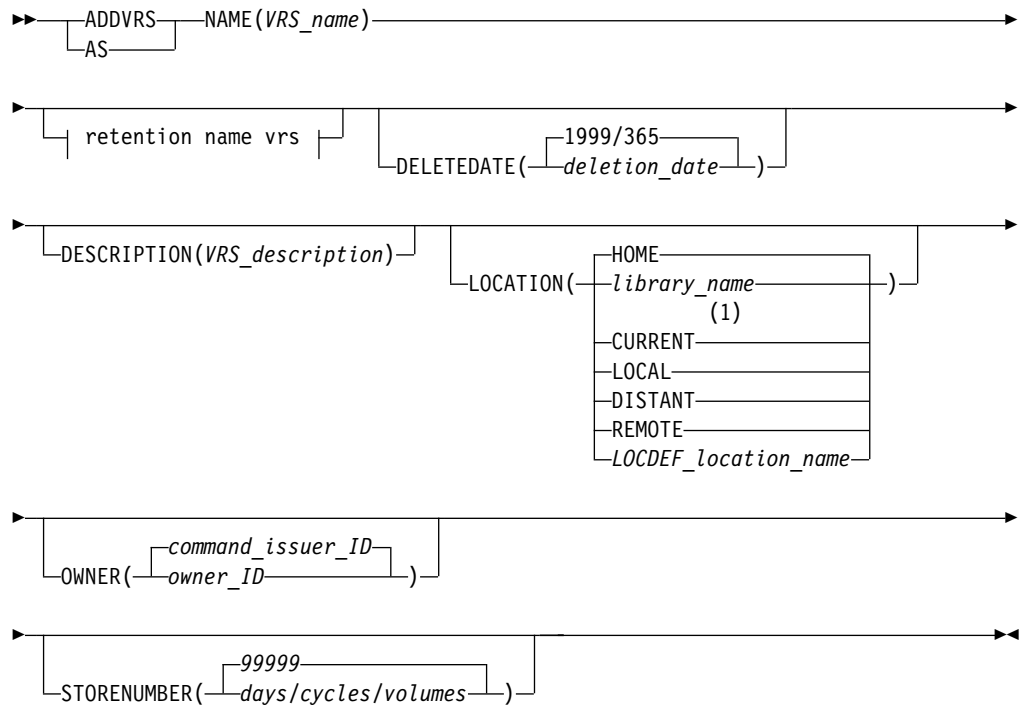

retention name vrs:

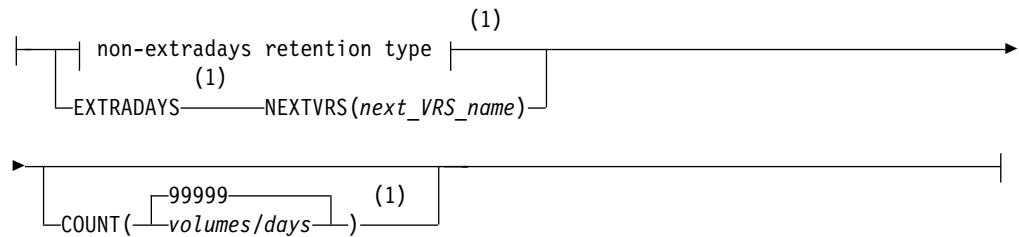

non-extradays retention type:

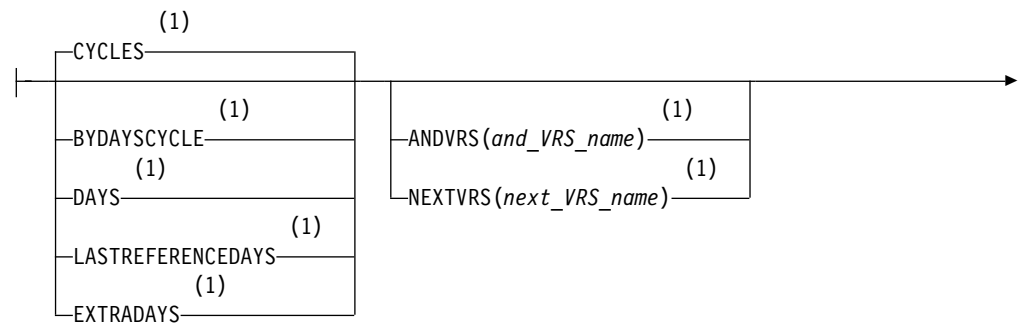

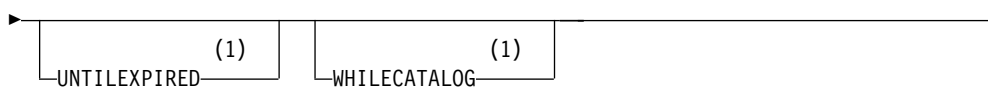

Notes:

- 1 This operand is honored when you specify the DFSMSrmm parmlib OPTION VRSEL(NEW) operand. When you run inventory management VRSEL(OLD), DFSMSrmm issues return code 4.

ADDVRS: Adding a Volume Vital Record Specification

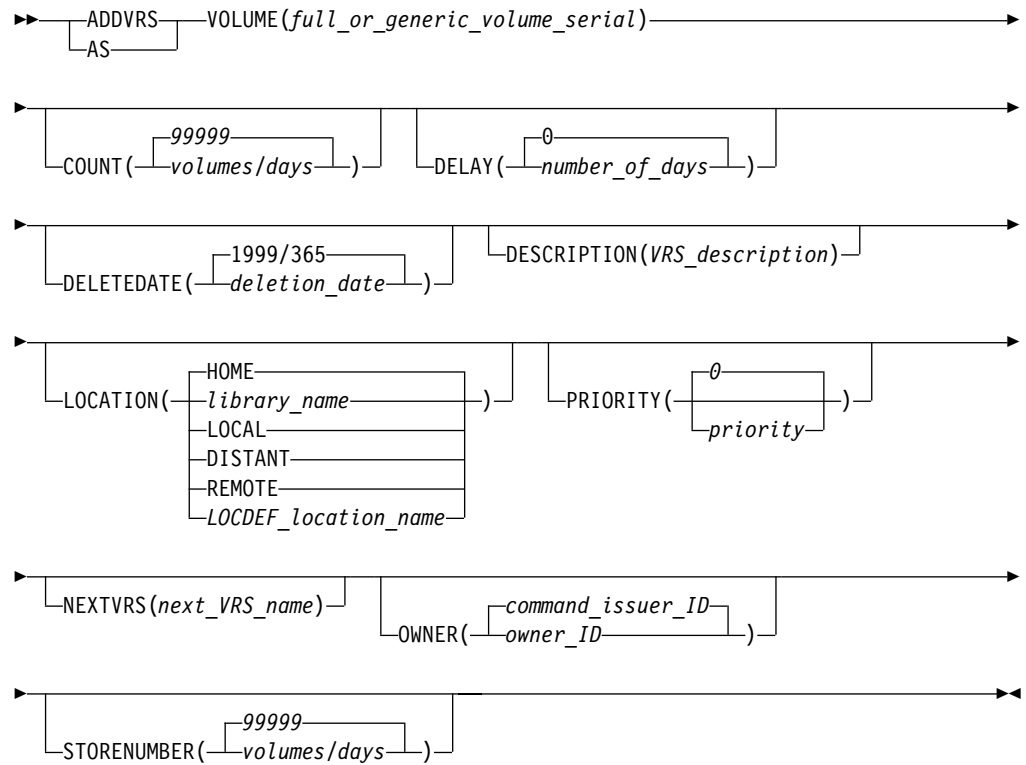

CHANGEDATASET: Changing Data Set Information

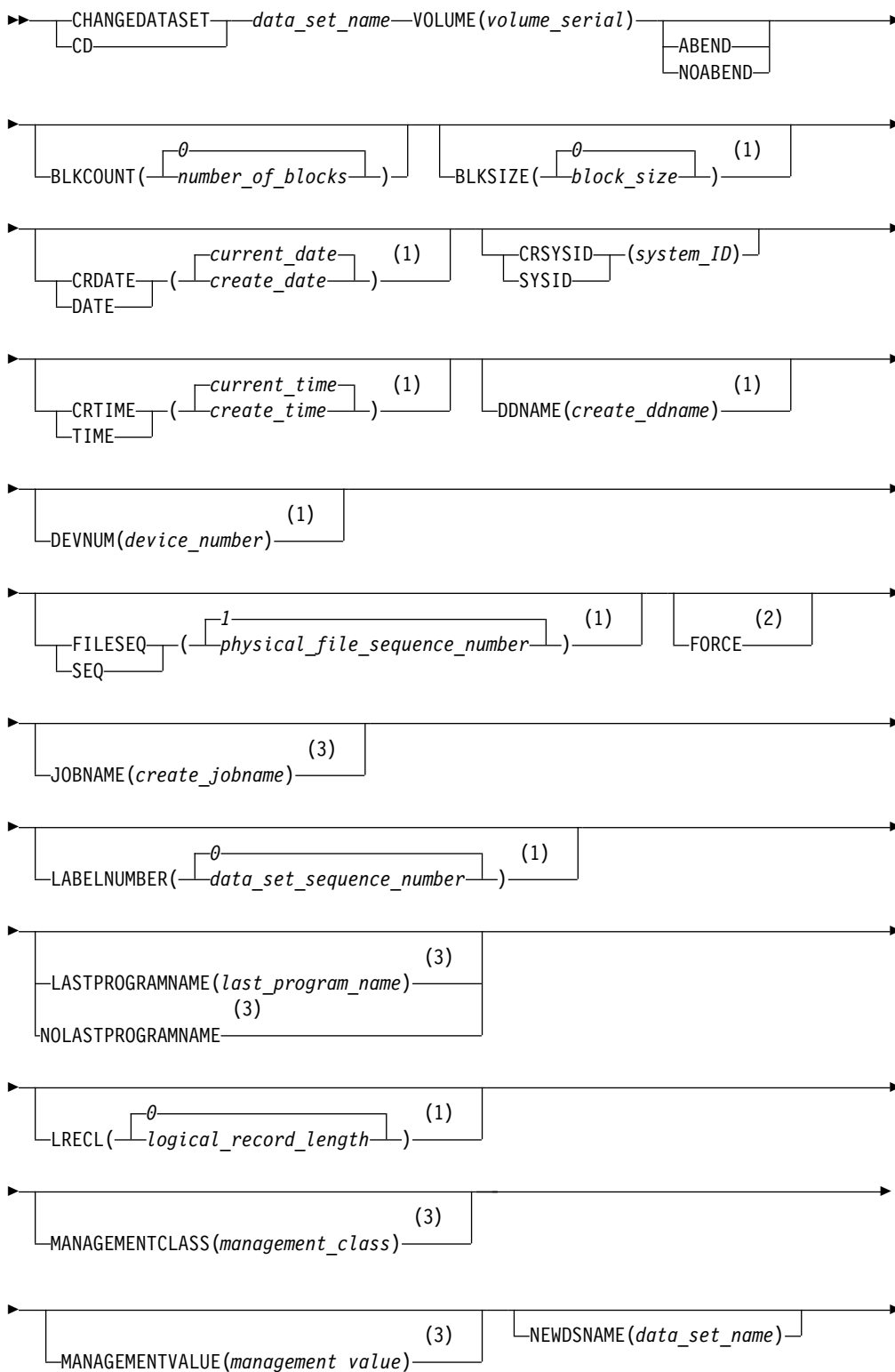

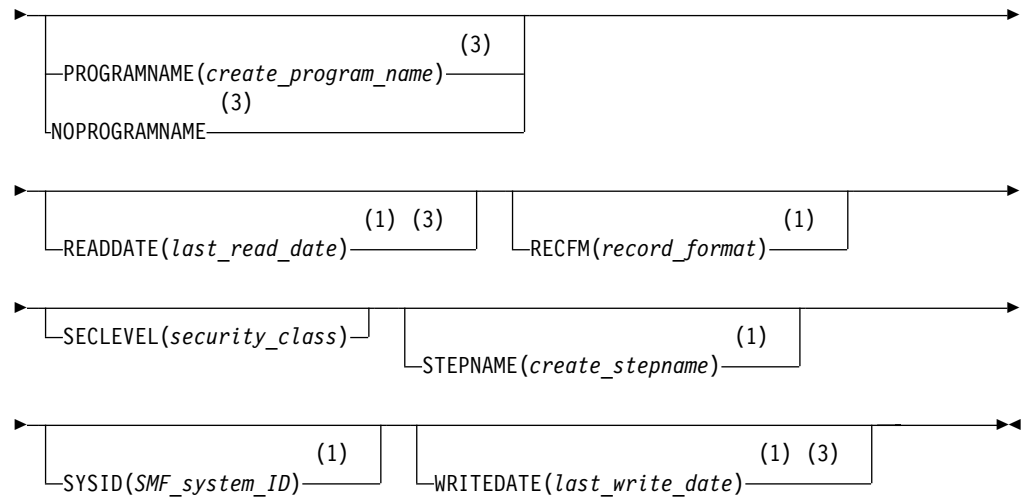

Notes:

- 1 This operand cannot be specified if DFSMSrmm has automatically recorded information about the volume when a data set on the volume was first opened.
- 2 Specify this operand to change a data set for a volume where information was recorded by DFSMSrmm during O/C/EOV processing. You must have CONTROL access to the STGADMIN.EDG.MASTER security resource and UPDATE access to the STGADMIN.EDG.FORCE security resource to use the FORCE operand.
- 3 This operand can only be specified by a user with CONTROL access to the STGADMIN.EDG.MASTER security resource. Owner authorization does not apply.

CHANGEOWNER: Changing Owner Information

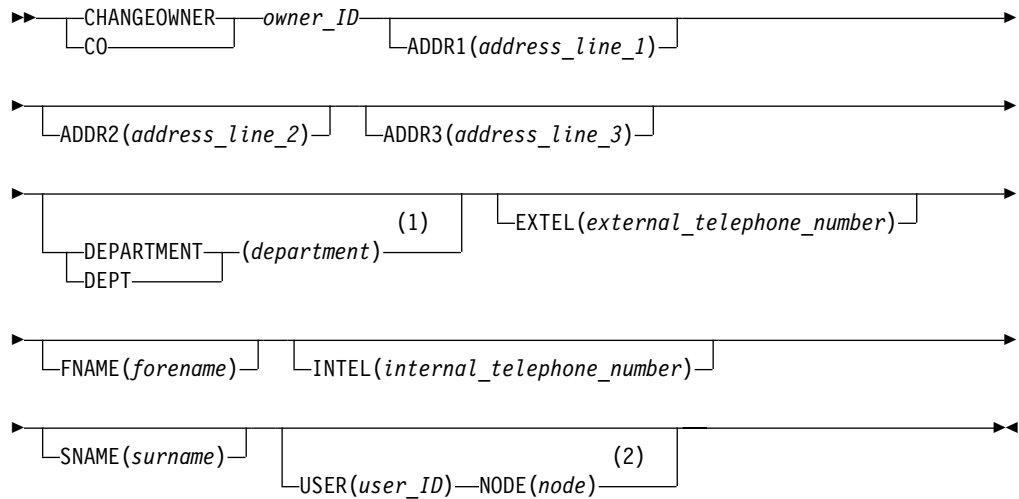

Notes:

- 1 The DEPARTMENT operand must contain at least one non-blank character.
- 2 The values you specify for USER(*user_ID*) and NODE(*node*) work together; if you delete one, you must also delete the other.

CHANGEPRODUCT: Changing Software Product Information

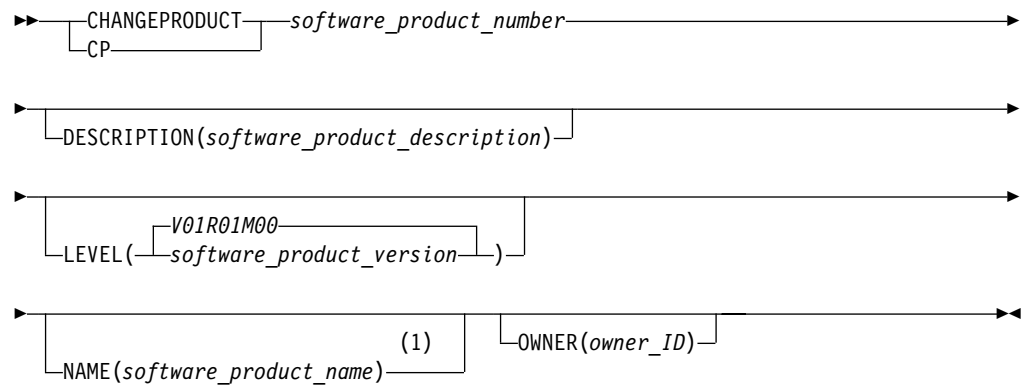

Notes:

- 1 The NAME operand must contain at least one non-blank character.

CHANGEVOLUME: Changing Volume Information

The CHANGEVOLUME operands are broken down into multiple syntax diagrams:

- CHANGEVOLUME: Confirmrelease and Global Movement Operands
- CHANGEVOLUME: Specific Volume Optional Operands which spans multiple pages.

CHANGEVOLUME: Confirmrelease and Global Movement Operands

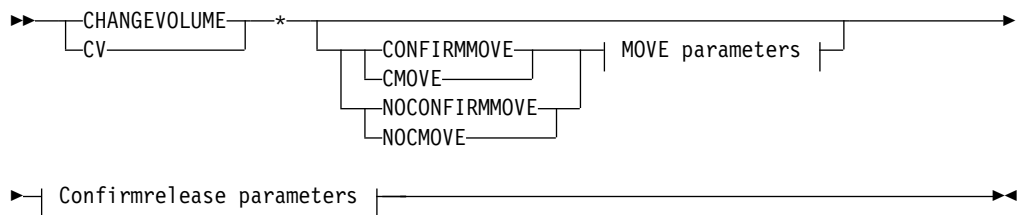

Confirmrelease parameters:

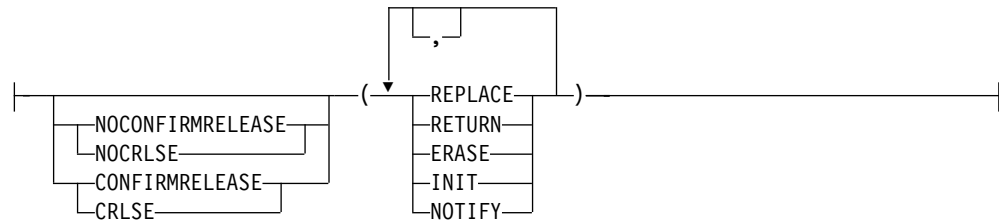

MOVE parameters:

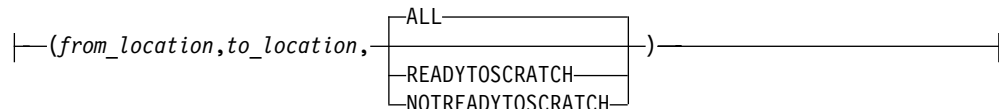

CHANGEVOLUME: Specific Volume Optional Operands

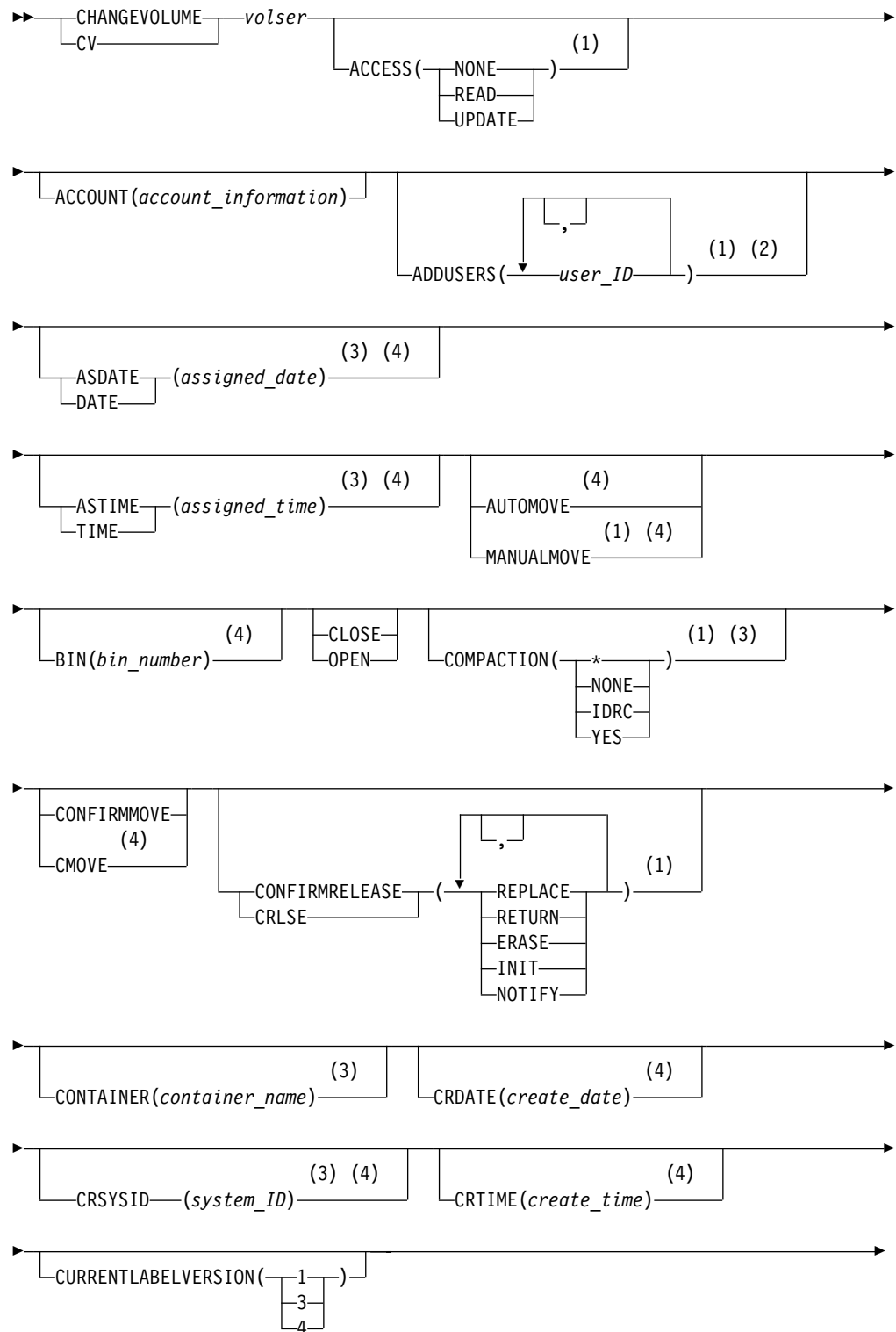

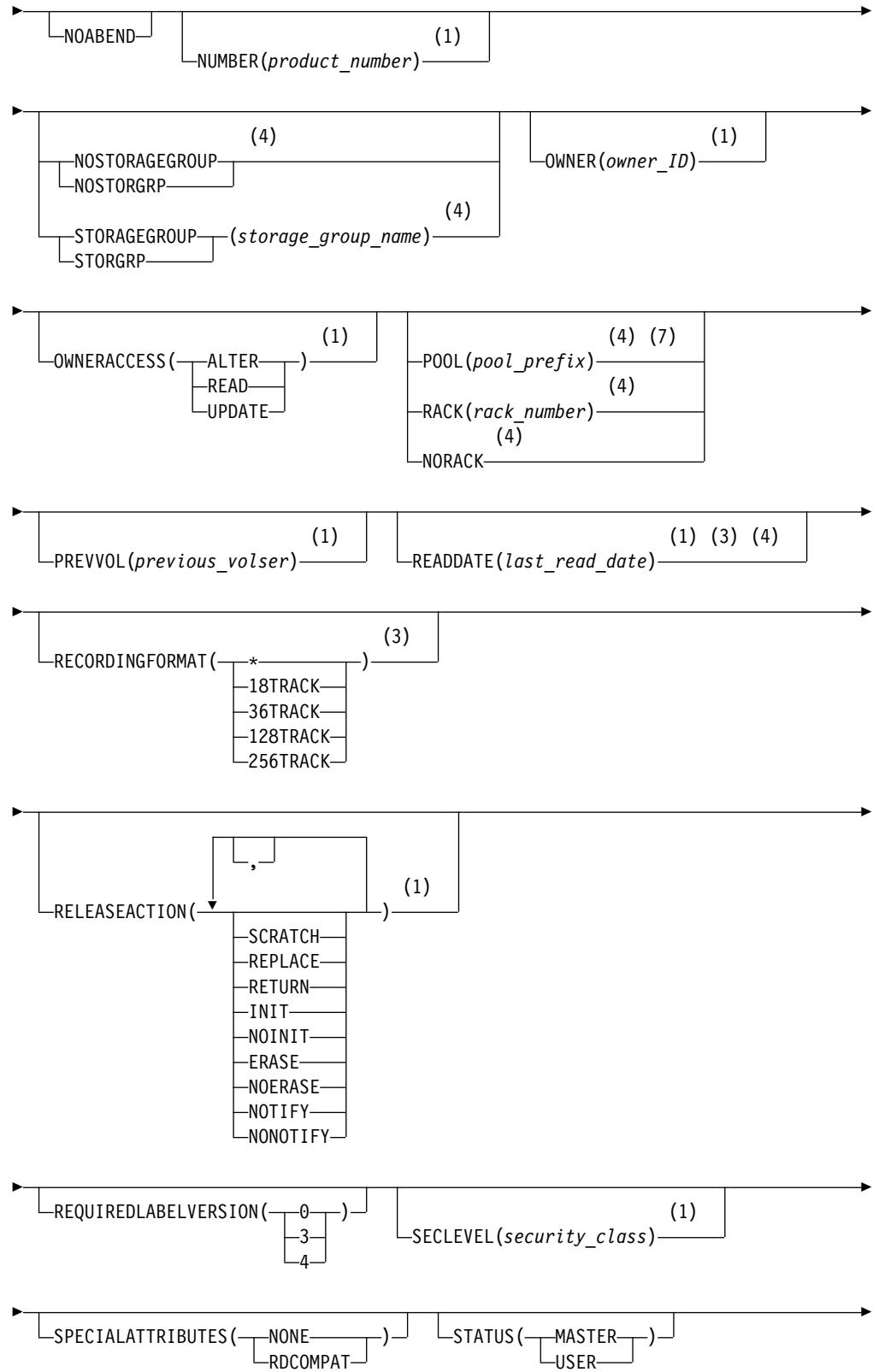

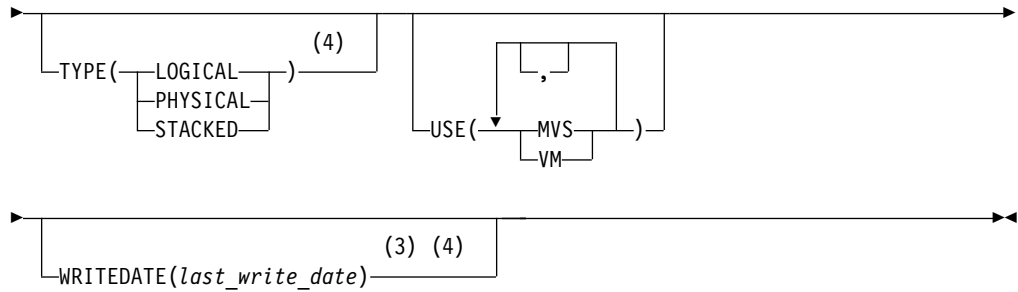

Notes:

- 1 This operand cannot be specified for a SCRATCH volume, unless you specify the STATUS operand.
- 2 You can specify a maximum of 12 user IDs.
- 3 You can specify this operand only if you also specify the FORCE operand. To use the FORCE operand, you must have CONTROL access to the STGADMIN.EDG.MASTER security resource and UPDATE access to the STGADMIN.EDG.FORCE security resource.
- 4 This operand can be specified if the user has CONTROL access to STGADMIN.EDG.MASTER resource.
- 5 This operand can be specified only if the volume resides in a system-managed library.
- 6 This operand can be specified to change a data set on a volume where information was recorded by DFSMSrmm during O/C/EOV processing. You must have CONTROL access to the STGADMIN.EDG.MASTER security resource and UPDATE access to the STGADMIN.EDG.FORCE security resource to use the FORCE operand.
- 7 This operand cannot be specified if the volume resides in an IBM Tape Library Dataserver.

DELETEBIN: Deleting Bin Number Information

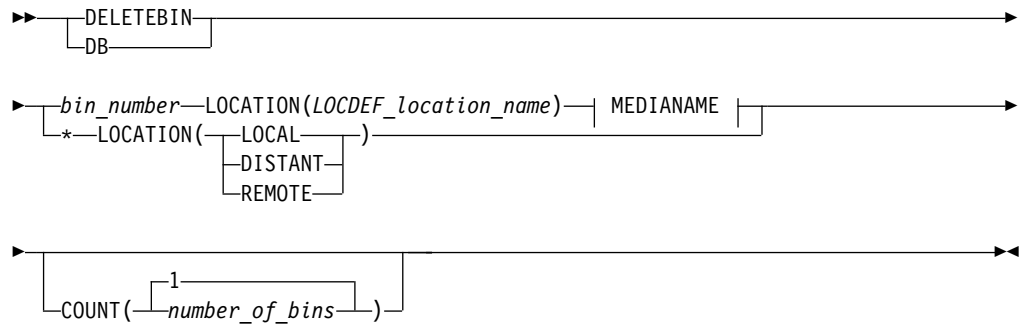

MEDIANAME:

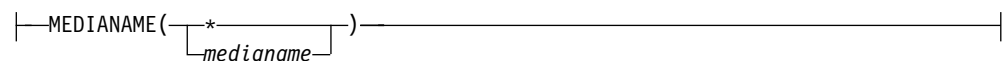

DELETEDATASET: Deleting Data Set Information

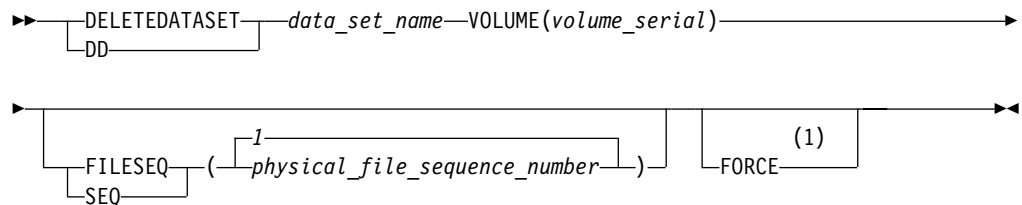

Notes:

- 1 Specify the FORCE operand to delete a data set for a volume where information was recorded by DFSMSrmm during O/C/EOV processing. You must have CONTROL access to the STGADMIN.EDG.MASTER security resource and UPDATE access to the STGADMIN.EDG.FORCE security resource to use the FORCE operand.

DELETEOWNER: Deleting Owner Information

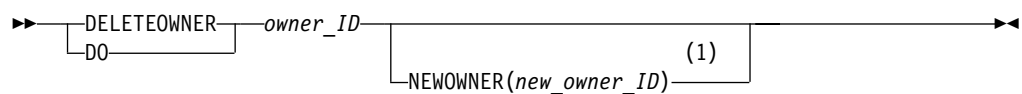

Notes:

- 1 The NEWOWNER operand must be specified to reassign volumes if the owner you are deleting owns one or more volumes.

DELETEPRODUCT: Deleting Software Product Information

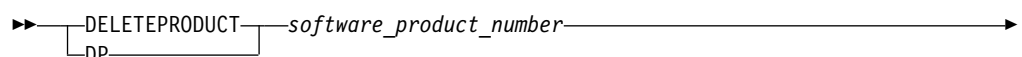

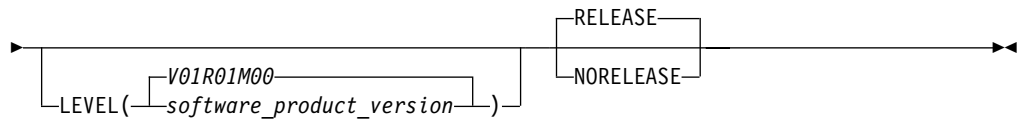

DELETERACK: Deleting Shelf Location Information

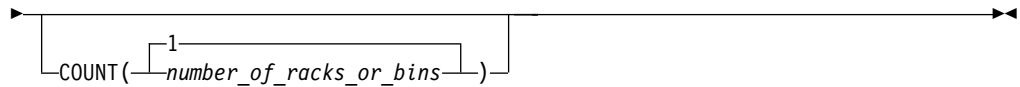
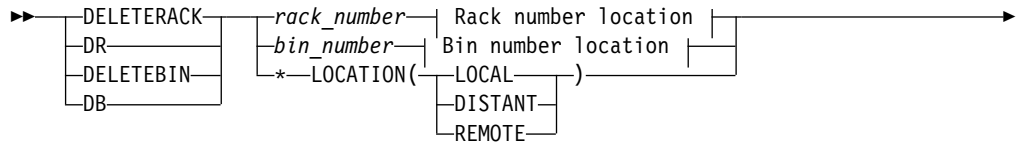

Rack number location:

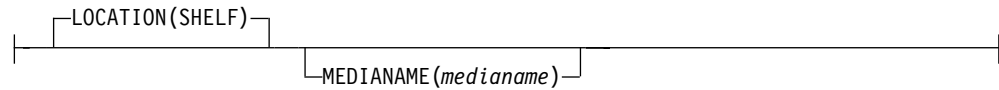

Bin number location:



DELETEVOLUME: Deleting Volume Information

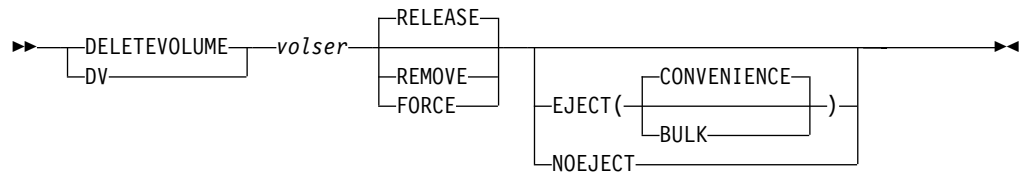

DELETEVRS: Deleting Vital Record Specification Information

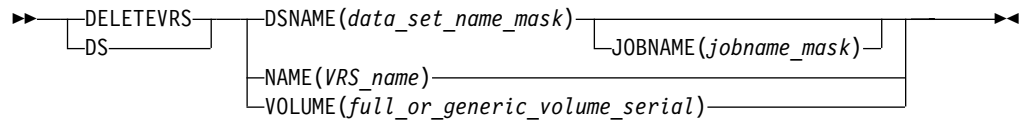

GETVOLUME: Requesting and Assigning Scratch Volumes

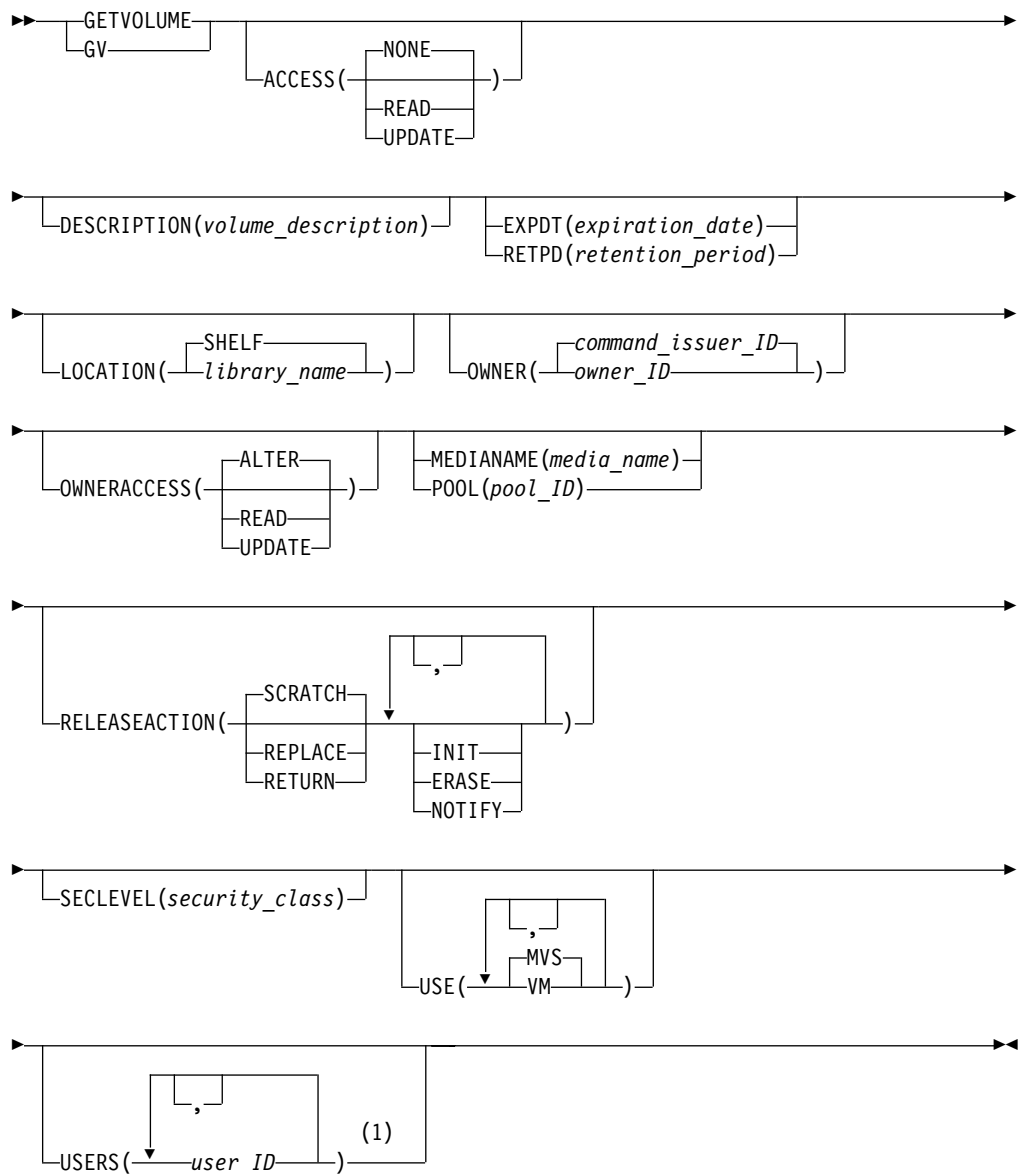

Notes:

- 1 You can specify a maximum of 12 user IDs.

LISTBIN: Displaying Information about a Shelf Location

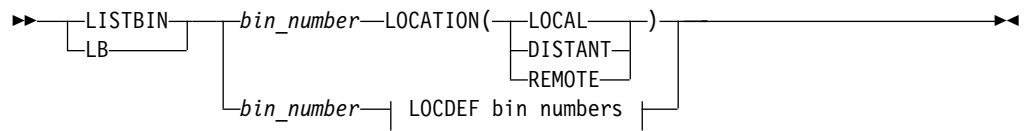

LOCDEF bin numbers:



LISTCONTROL: Displaying Parmlib Options and Control Information

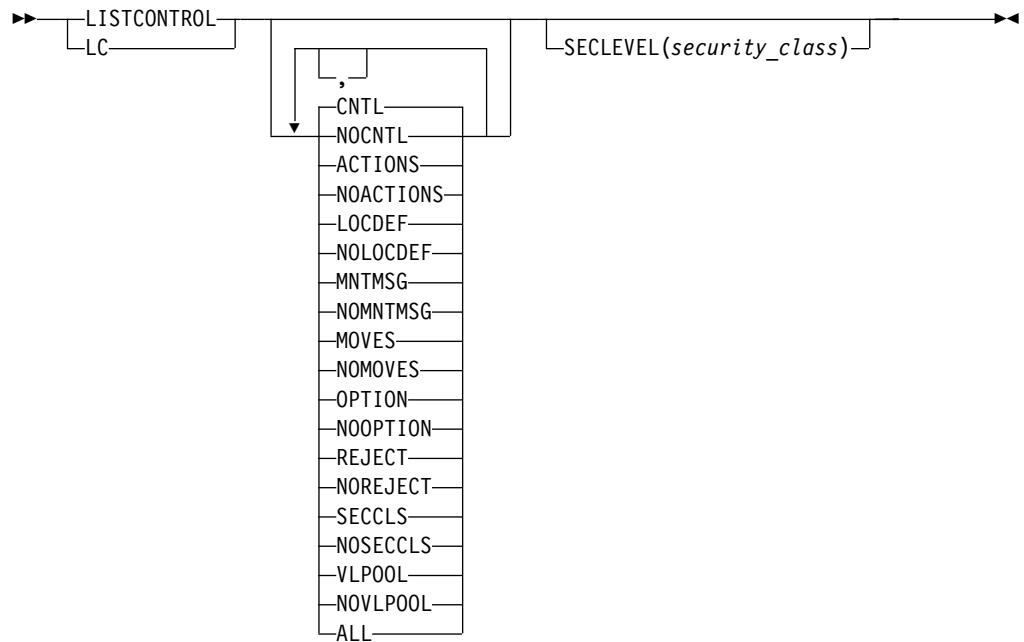

LISTDATASET: Displaying Information about a Data Set

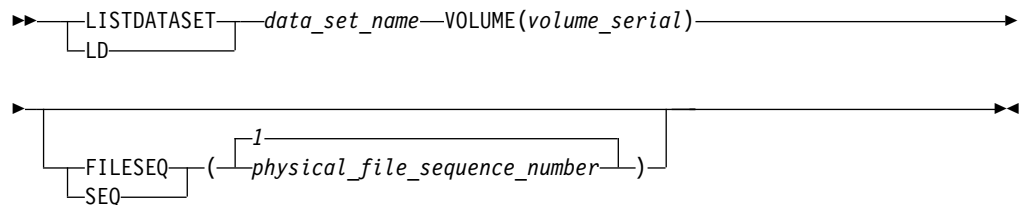

LISTOWNER: Displaying Information about an Owner



LISTPRODUCT: Displaying Information about a Software Product

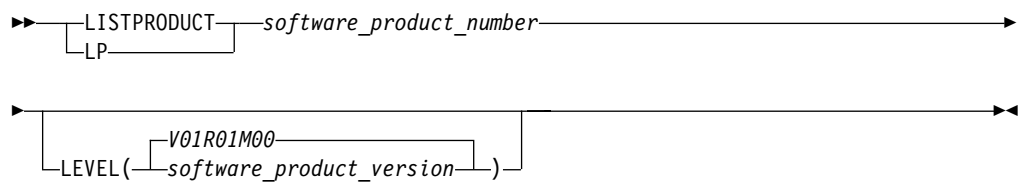

LISTTRACK: Displaying Information about a Shelf Location

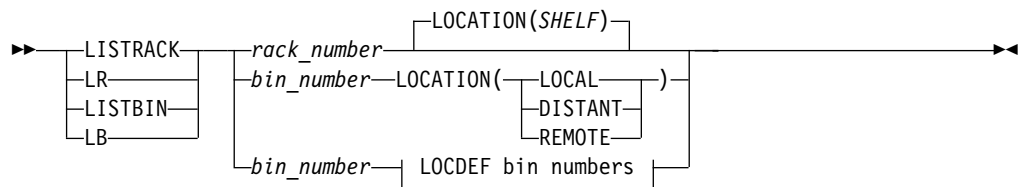

LOCDEF bin numbers:



LISTVOLUME: Displaying Information about a Volume

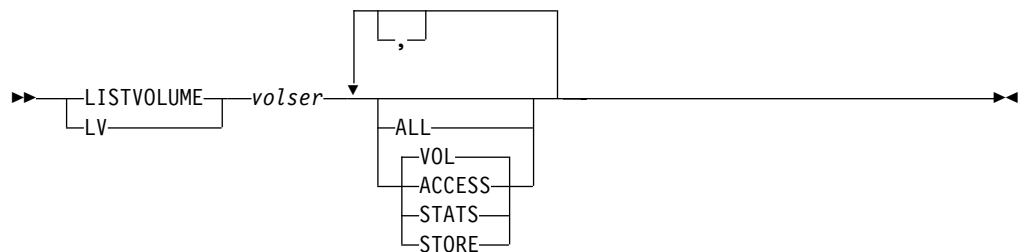

LISTVRS: Displaying Information about a Vital Record Specification

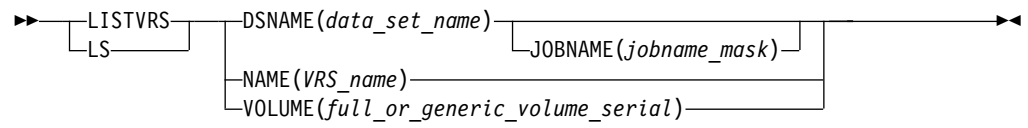

SEARCHBIN: Creating a List of Bin Numbers

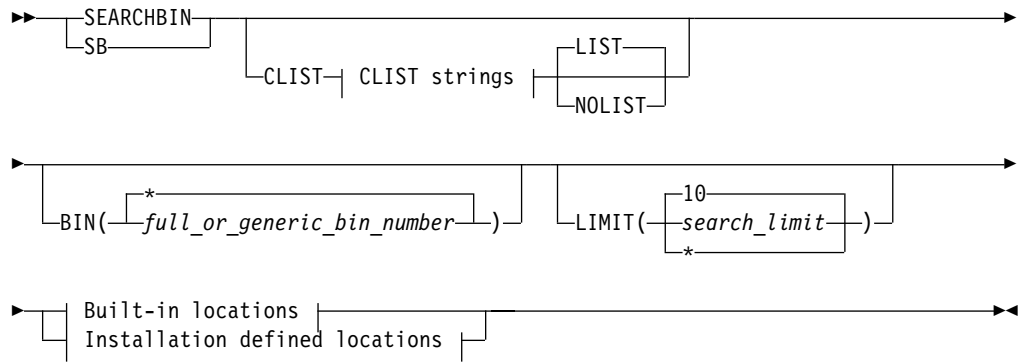

CLIST strings:

(*prefix_string*,*suffix_string*)

Built-in locations:

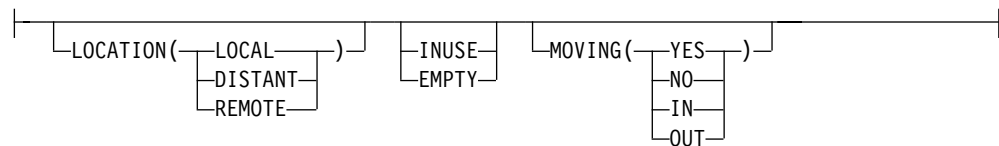

Installation defined locations:

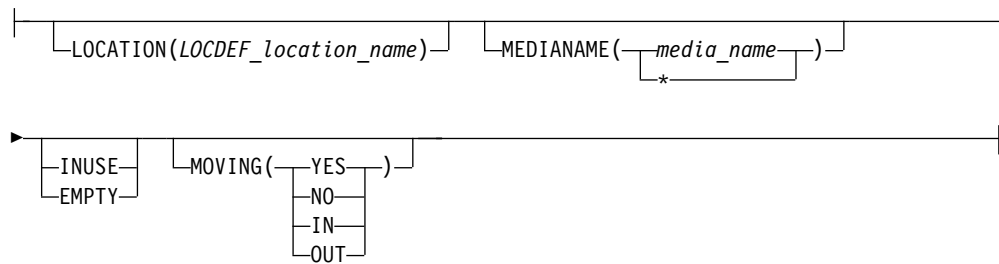

SEARCHDATASET: Creating a List of Data Sets

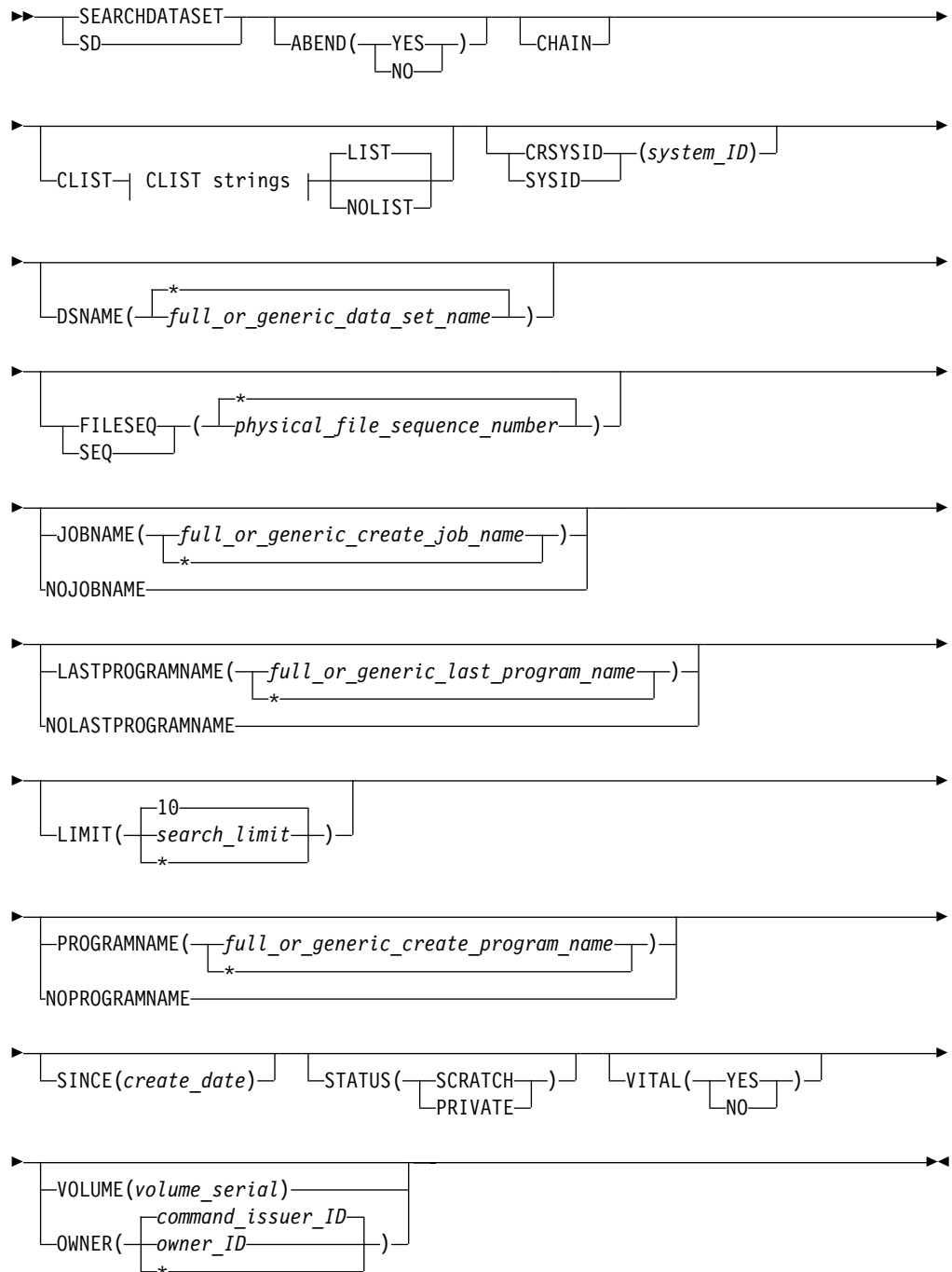

CLIST strings:

(prefix_string, suffix_string)

SEARCHPRODUCT: Creating a List of Software Products

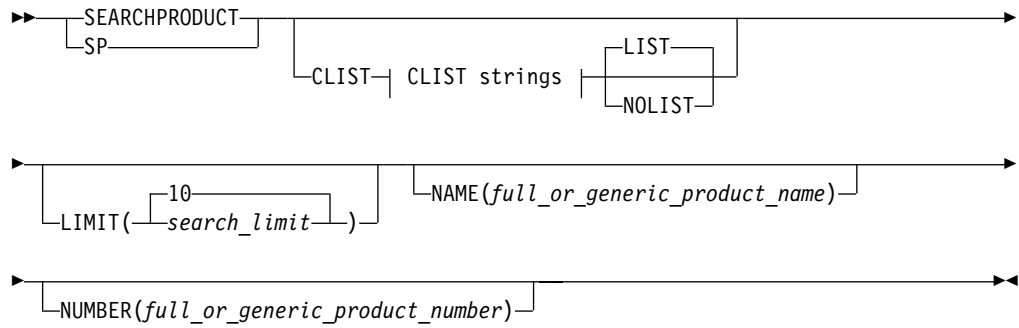

CLIST strings:

(prefix_string, suffix_string)

SEARCHRACK: Creating a List of Shelf Locations

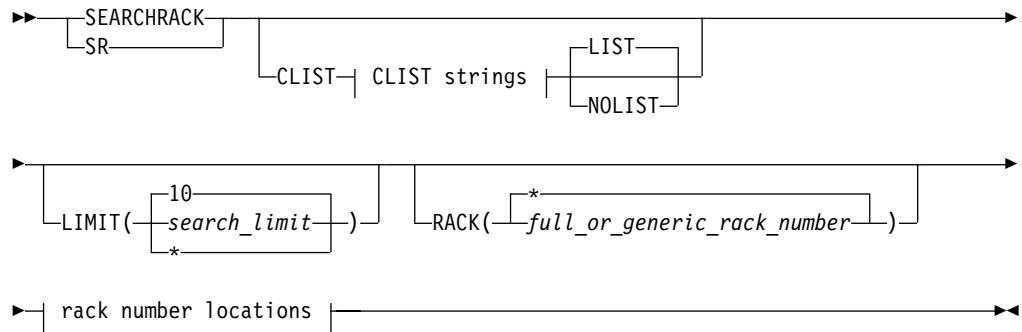

CLIST strings:

(prefix_string, suffix_string)

rack number locations:

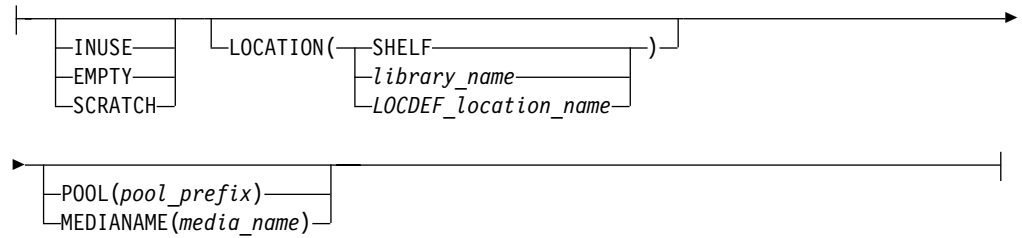

SEARCHVOLUME: Creating a List of Volumes

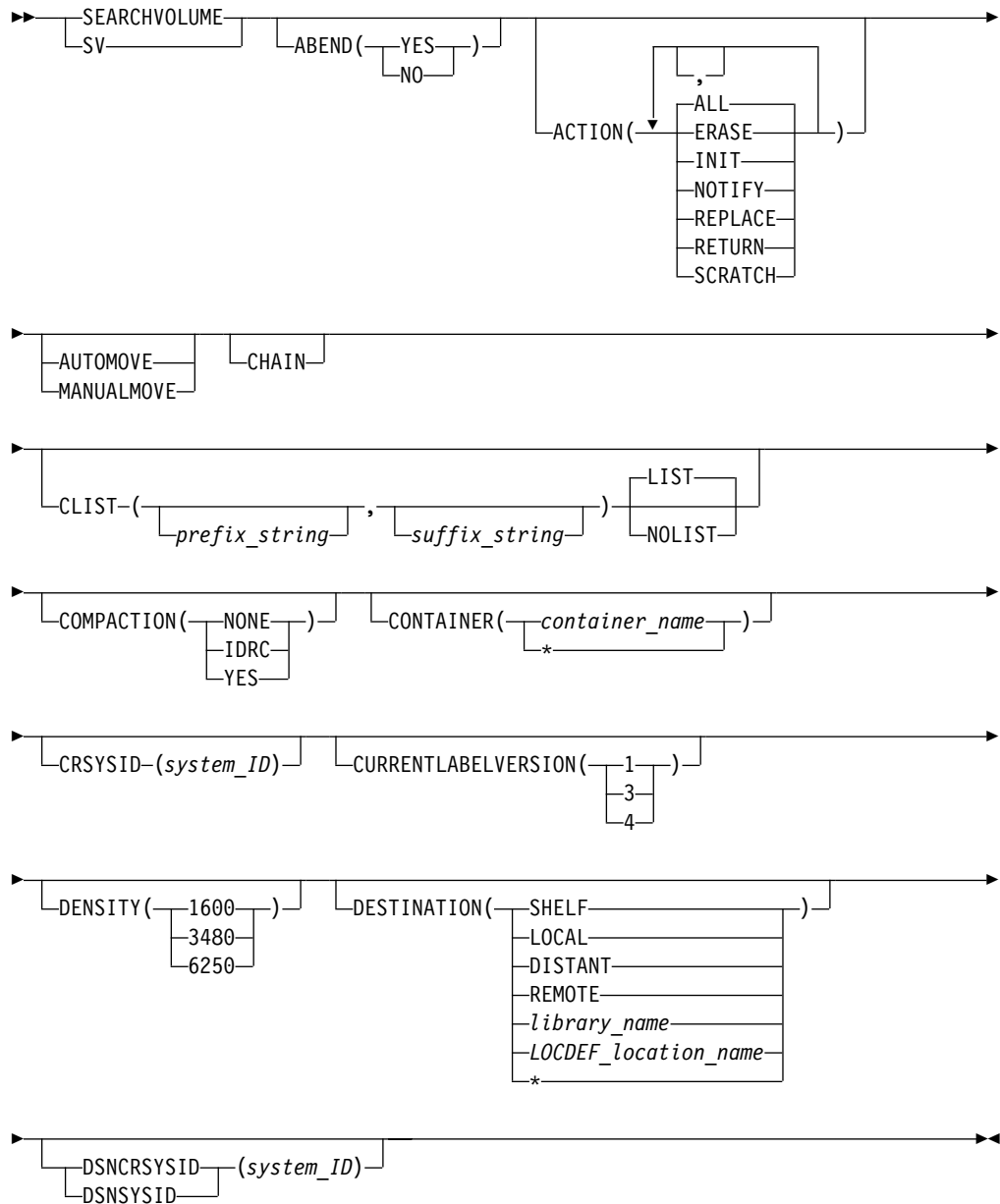

SEARCHVOLUME: Optional Operands

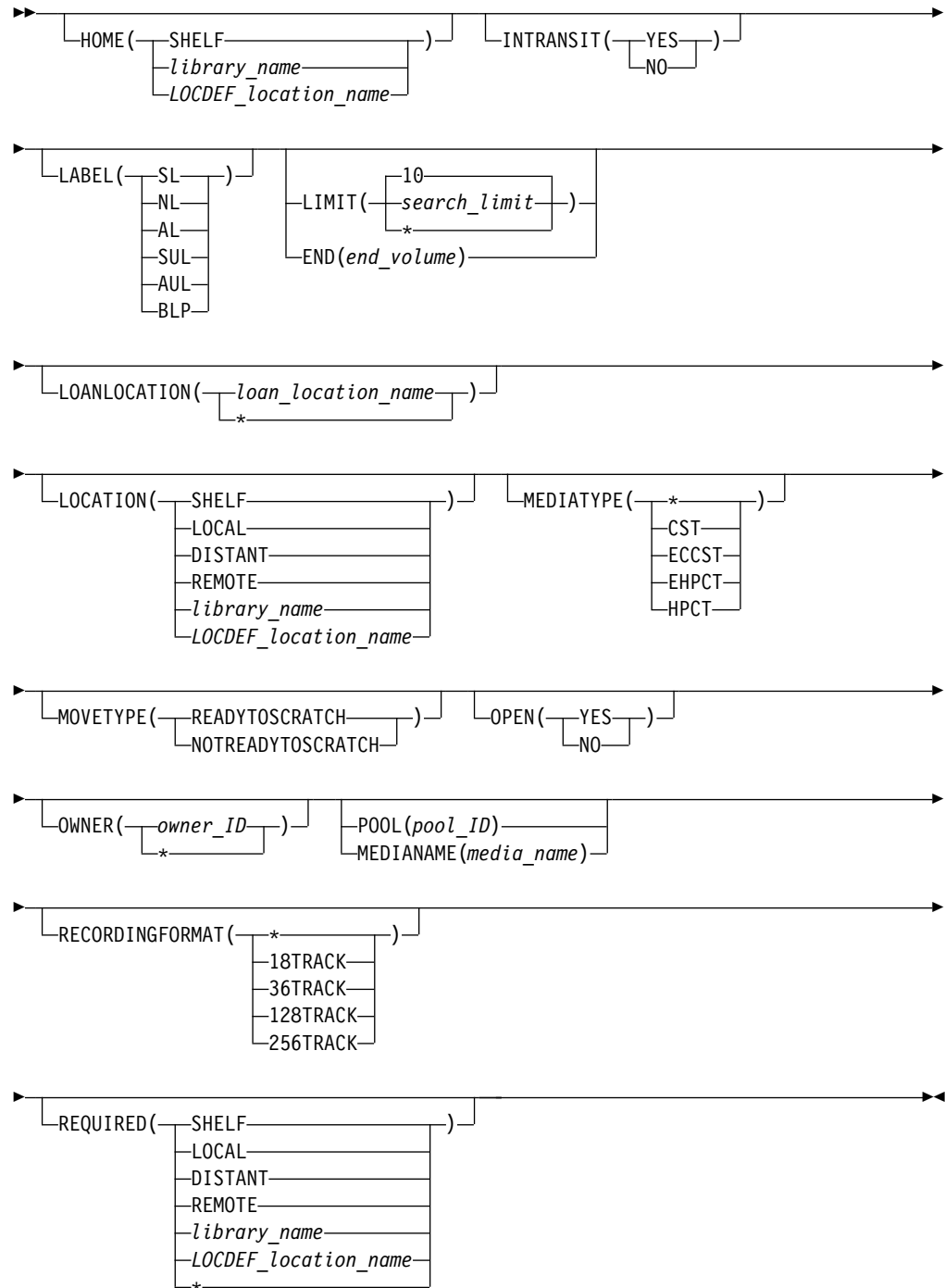

SEARCHVOLUME: Optional Operands (Cont.)

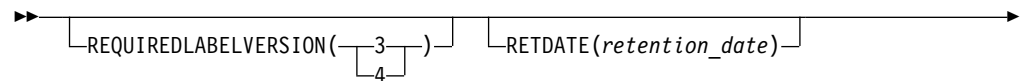

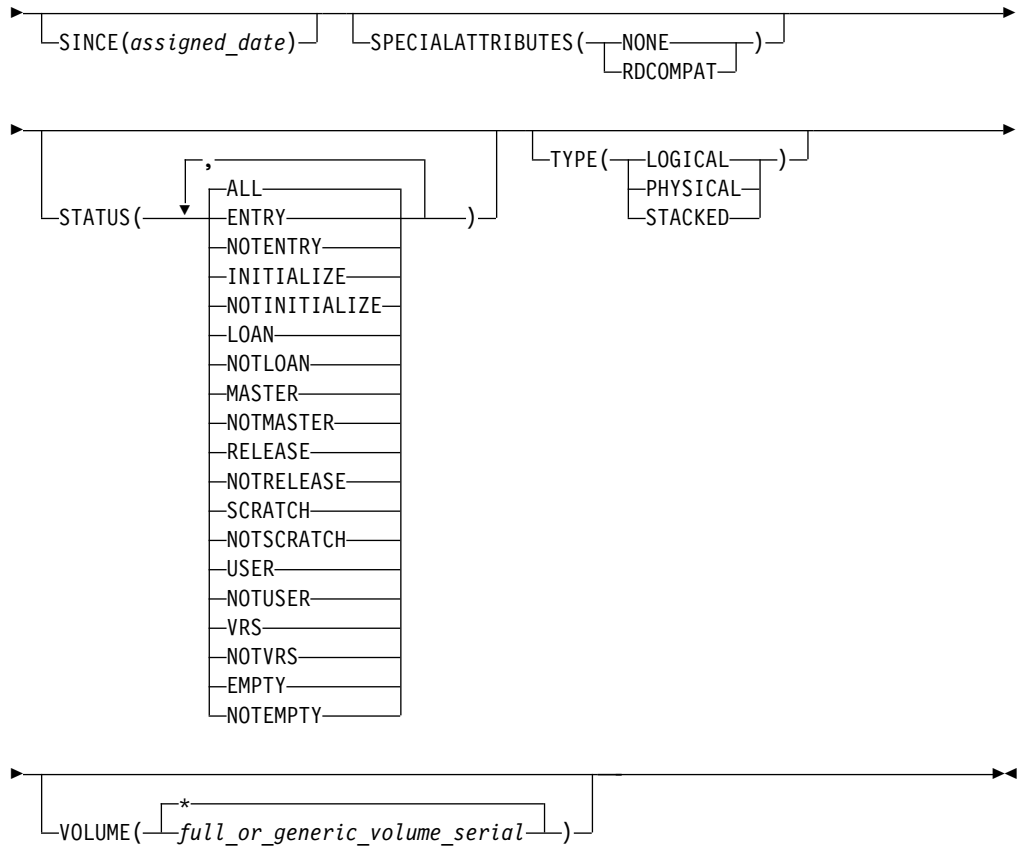

SEARCHVRS: Creating a List of Vital Record Specifications

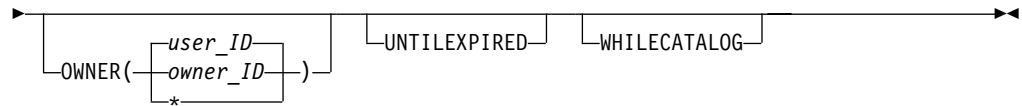
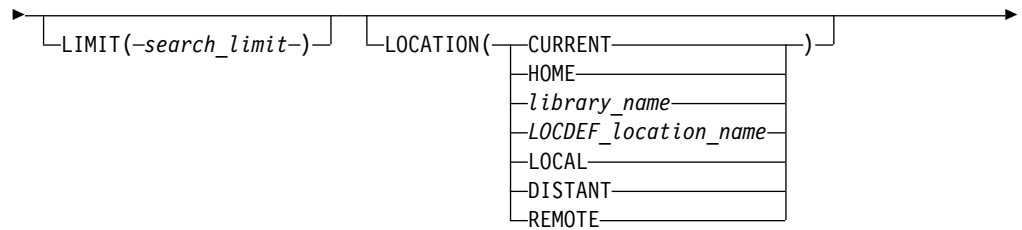
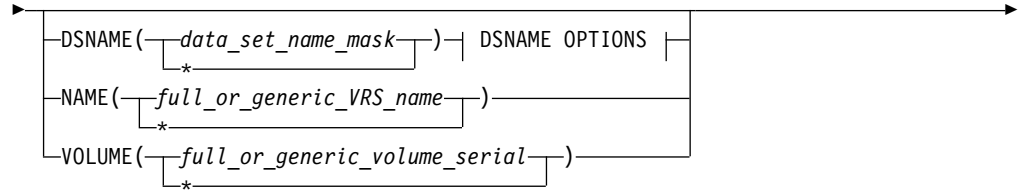
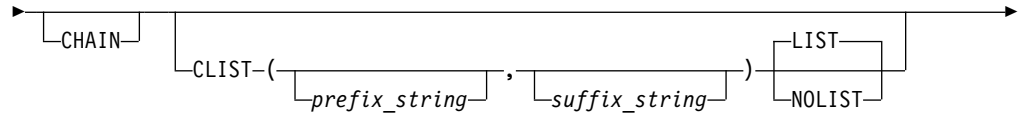
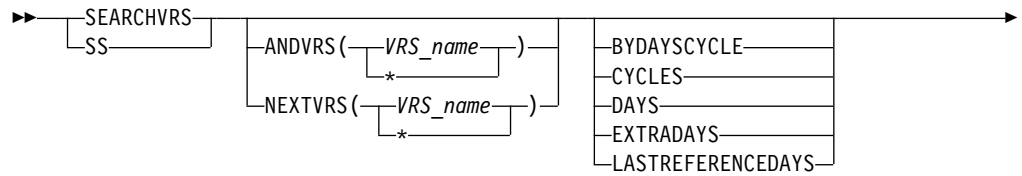

DSNAME OPTIONS:

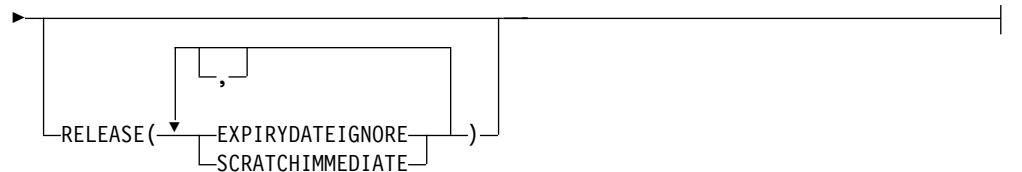
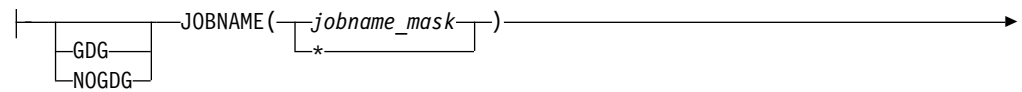

Appendix. Accessibility

Accessibility features help a user who has a physical disability, such as restricted mobility or limited vision, to use software products successfully. The major accessibility features in z/OS enable users to:

- Use assistive technologies such as screen-readers and screen magnifier software
- Operate specific or equivalent features using only the keyboard
- Customize display attributes such as color, contrast, and font size

Using assistive technologies

Assistive technology products, such as screen-readers, function with the user interfaces found in z/OS. Consult the assistive technology documentation for specific information when using it to access z/OS interfaces.

Keyboard navigation of the user interface

Users can access z/OS user interfaces using TSO/E or ISPF. Refer to *z/OS TSO/E Primer*, *z/OS TSO/E User's Guide*, and *z/OS ISPF User's Guide Volume I* for information about accessing TSO/E and ISPF interfaces. These guides describe how to use TSO/E and ISPF, including the use of keyboard shortcuts or function keys (PF keys). Each guide includes the default settings for the PF keys and explains how to modify their functions.

Notices

This information was developed for products and services offered in the U.S.A. IBM may not offer the products, services, or features discussed in this document in other countries. Consult your local IBM representative for information on the products and services currently available in your area. Any reference to an IBM product, program, or service is not intended to state or imply that only that IBM product, program, or service may be used. Any functionally equivalent product, program, or service that does not infringe any IBM intellectual property right may be used instead. However, it is the user's responsibility to evaluate and verify the operation of any non-IBM product, program, or service.

IBM may have patents or pending patent applications covering subject matter described in this document. The furnishing of this document does not give you any license to these patents. You can send license inquiries, in writing, to:

IBM Director of Licensing
IBM Corporation
North Castle Drive
Armonk, NY 10504-1785
U.S.A.

For license inquiries regarding double-byte (DBCS) information, contact the IBM Intellectual Property Department in your country or send inquiries, in writing, to:

IBM World Trade Asia Corporation Licensing
2-31 Roppongi 3-chome, Minato-ku
Tokyo 106, Japan

The following paragraph does not apply to the United Kingdom or any other country where such provisions are inconsistent with local law:

INTERNATIONAL BUSINESS MACHINES CORPORATION PROVIDES THIS PUBLICATION "AS IS" WITHOUT WARRANTY OF ANY KIND, EITHER EXPRESS OR IMPLIED, INCLUDING, BUT NOT LIMITED TO, THE IMPLIED WARRANTIES OF NON-INFRINGEMENT, MERCHANTABILITY OR FITNESS FOR A PARTICULAR PURPOSE. Some states do not allow disclaimer of express or implied warranties in certain transactions, therefore, this statement may not apply to you.

This information could include technical inaccuracies or typographical errors. Changes are periodically made to the information herein; these changes will be incorporated in new editions of the publication. IBM may make improvements and/or changes in the product(s) and/or the program(s) described in this publication at any time without notice.

IBM may use or distribute any of the information you supply in any way it believes appropriate without incurring any obligation to you.

Licensees of this program who wish to have information about it for the purpose of enabling: (i) the exchange of information between independently created programs and other programs (including this one) and (ii) the mutual use of the information which has been exchanged, should contact:

IBM Corporation
Information Enabling Requests
Dept. DZWA
5600 Cottle Road
San Jose, CA 95193 U.S.A.

Such information may be available, subject to appropriate terms and conditions, including in some cases, payment of a fee.

The licensed program described in this information and all licensed material available for it are provided by IBM under terms of the IBM Customer Agreement, IBM International Program License Agreement, or any equivalent agreement between us.

Programming Interface Information

This publication documents intended Programming Interfaces that allow the customer to write programs to obtain the services of DFSMSrmm.

Trademarks

The following terms are trademarks of the IBM Corporation in the United States, or other countries, or both:

DFSMSrmm
IBM
z/OS

Other company, product, and service names may be trademarks or service marks of others.

Readers' Comments — We'd Like to Hear from You

**z/OS
DFSMSrmm Command
Reference Summary**

Publication No. SX26-6022-01

Overall, how satisfied are you with the information in this book?

	Very Satisfied	Satisfied	Neutral	Dissatisfied	Very Dissatisfied
Overall satisfaction	<input type="checkbox"/>	<input type="checkbox"/>	<input type="checkbox"/>	<input type="checkbox"/>	<input type="checkbox"/>

How satisfied are you that the information in this book is:

	Very Satisfied	Satisfied	Neutral	Dissatisfied	Very Dissatisfied
Accurate	<input type="checkbox"/>	<input type="checkbox"/>	<input type="checkbox"/>	<input type="checkbox"/>	<input type="checkbox"/>
Complete	<input type="checkbox"/>	<input type="checkbox"/>	<input type="checkbox"/>	<input type="checkbox"/>	<input type="checkbox"/>
Easy to find	<input type="checkbox"/>	<input type="checkbox"/>	<input type="checkbox"/>	<input type="checkbox"/>	<input type="checkbox"/>
Easy to understand	<input type="checkbox"/>	<input type="checkbox"/>	<input type="checkbox"/>	<input type="checkbox"/>	<input type="checkbox"/>
Well organized	<input type="checkbox"/>	<input type="checkbox"/>	<input type="checkbox"/>	<input type="checkbox"/>	<input type="checkbox"/>
Applicable to your tasks	<input type="checkbox"/>	<input type="checkbox"/>	<input type="checkbox"/>	<input type="checkbox"/>	<input type="checkbox"/>

Please tell us how we can improve this book:

Thank you for your responses. May we contact you? Yes No

When you send comments to IBM, you grant IBM a nonexclusive right to use or distribute your comments in any way it believes appropriate without incurring any obligation to you.

Name

Address

Company or Organization

Phone No.



Fold and Tape

Please do not staple

Fold and Tape



NO POSTAGE
NECESSARY
IF MAILED IN THE
UNITED STATES

BUSINESS REPLY MAIL

FIRST-CLASS MAIL PERMIT NO. 40 ARMONK, NEW YORK

POSTAGE WILL BE PAID BY ADDRESSEE

IBM Corporation
RCF Processing Department
M86/050
5600 Cottle Road
San Jose, CA U.S.A 95193-0001

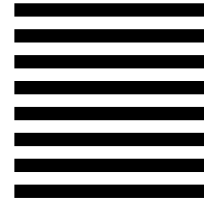

Fold and Tape

Please do not staple

Fold and Tape



Program Number: 5694-A01



Printed in the United States of America
on recycled paper containing 10%
recovered post-consumer fiber.

SX26-6022-01

