

Virtual Machine
Remote Spooling Communications Subsystem
Networking



Reference Summary

Version 3 Release 2

Virtual Machine
Remote Spooling Communications Subsystem
Networking



Reference Summary

Version 3 Release 2

Note:

Before using this information and the product it supports, read the information in "Notices" on page v.

Fourth Edition (July 1999)

This edition applies to Version 3, Release 2, Modification 0 of IBM® Virtual Machine Remote Spooling Communications Subsystem Networking, (VM/RSCS) (product number 5684-096) and to all subsequent releases and modifications until otherwise indicated in new editions.

This edition replaces SX24-5257-03.

© **Copyright International Business Machines Corporation 1990, 1999. All rights reserved.**

Note to U.S. Government Users — Documentation related to restricted rights — Use, duplication or disclosure is subject to restrictions set forth in GSA ADP Schedule Contract with IBM Corp.

Contents

Notices	v
Trademarks	vii
How to Send Your Comments	vii
Issuing Commands	1
Presentation of Commands	2
Related Publications	3
Understanding Syntax Diagrams	3
RSCS Commands	7
Link Operational Parameters	35
Configuration File Statements	49
Terminal SIGNON Cards	69
Diagnostic Subcommands	71
RSCS Interchange Commands	75
RSCS Interchange Configuration File Statements	79
Other Commands Used with RSCS	85
Bibliography	91
RSCS Library	91

Notices

This information was developed for products and services offered in the U.S.A. IBM may not offer the products, services, or features discussed in this document in other countries. Consult your local IBM representative for information on the products and services currently available in your area. Any reference to an IBM product, program, or service is not intended to state or imply that only that IBM product, program, or service may be used. Any functionally equivalent product, program, or service that does not infringe any IBM intellectual property right may be used instead. However, it is the user's responsibility to evaluate and verify the operation of any non-IBM product, program, or service.

IBM may have patents or pending patent applications covering subject matter described in this document. The furnishing of this document does not give you any license to these patents. You can send license inquiries, in writing, to:

IBM Director of Licensing
IBM Corporation
North Castle Drive
Armonk, NY 10504-1785
U.S.A.

For license inquiries regarding double-byte (DBCS) information, contact the IBM Intellectual Property Department in your country or send inquiries, in writing, to:

IBM World Trade Asia Corporation
Licensing
2-31 Roppongi 3-chome, Minato-ku
Tokyo 106, Japan

The following paragraph does not apply to the United Kingdom or any other country where such provisions are inconsistent with local law: INTERNATIONAL BUSINESS MACHINES CORPORATION PROVIDES THIS PUBLICATION "AS IS" WITHOUT WARRANTY OF ANY KIND, EITHER EXPRESS OR IMPLIED, INCLUDING, BUT NOT LIMITED TO, THE IMPLIED WARRANTIES OF NON-INFRINGEMENT, MERCHANTABILITY OR FITNESS FOR A PARTICULAR PURPOSE. Some states do not allow disclaimer of express or implied warranties in certain transactions, therefore, this statement may not apply to you.

This information could include technical inaccuracies or typographical errors. Changes are periodically made to the information herein; these changes will be incorporated in new editions of the publication. IBM may make improvements and/or changes to the product(s) and/or the program(s) described in this publication at any time without notice.

Any references in this information to non-IBM Web sites are provided for convenience only and do not in any manner serve as an endorsement of those Web sites. The materials at those Web sites are not part of the materials for this IBM product and use of those Web sites is at your own risk.

IBM may use or distribute any of the information you supply in any way it believes appropriate without incurring any obligation to you.

Licensees of this program who wish to have information about it for the purpose of enabling: (i) the exchange of information between independently created programs and other programs (including this one) and (ii) the mutual use of the information which has been exchanged, should contact:

IBM Corporation
Mail Station P300,
522 South Road
Poughkeepsie, NY 12601-5400
U.S.A.
Attention: Information Request

Such information may be available, subject to appropriate terms and conditions, including in some cases, payment of a fee.

The licensed program described in this document and all licensed material available for it are provided by IBM under terms of the IBM Customer Agreement, IBM International Program License Agreement or any equivalent agreement between us.

Any performance data contained herein was determined in a controlled environment. Therefore, the results obtained in other operating environments may vary significantly. Some measurements may have been made on development-level systems and there is no guarantee that these measurements will be the same on generally available systems. Furthermore, some measurement may have been estimated through extrapolation. Actual results may vary. Users of this document should verify the applicable data for their specific environment.

Information concerning non-IBM products was obtained from the suppliers of those products, their published announcements or other publicly available sources. IBM has not tested those products and cannot confirm the accuracy of performance, compatibility or any other claims related to non-IBM products. Questions on the capabilities on non-IBM products should be addressed to the suppliers of those products.

All statements regarding IBM's future direction or intent are subject to change or withdrawal without notice, and represent goals and objectives only.

This information contains examples of data and reports used in daily business operations. To illustrate them as completely as possible, the examples include the names of individuals, companies, brands, and products. All of these names are fictitious and any similarity to the names and addresses used by an actual business enterprise is entirely coincidental.

COPYRIGHT LICENSE:

This information contains sample application programs in source language, which illustrates programming techniques on various operating platforms. You may copy,

modify, and distribute these sample programs in any form without payment to IBM, for the purposes of developing, using, marketing or distributing application programs conforming to the application programming interface for the operating platform for which the sample programs are written. These examples have not been thoroughly tested under all conditions. IBM, therefore, cannot guarantee or imply reliability, serviceability, or function of these programs. You may copy, modify, and distribute these sample programs in any form without payment to IBM for the purposes of developing, using, marketing, or distributing application programs conforming to IBM's application programming interfaces.

Trademarks

The following terms are trademarks of the International Business Machines Corporation in the United States, or other countries, or both:

APL2	ESCON
IBM	
Virtual Machine/Enterprise Systems Architecture	VM/ESA
VTAM	

Other company, product, and service names may be trademarks or service marks of others.

How to Send Your Comments

Your feedback is important in helping to provide the most accurate and high-quality information. If you have any comments about this book or any other VM/ESA documentation:

- Visit our home page at:
<http://www.ibm.com/s390/vm/related/rscs>
There you will find the feedback page where you can enter and submit your comments.
- Send your comments by electronic mail to one of the following addresses:

Format	Address
Internet	pubrcf@vnet.ibm.com
IBM Mail	USIB2L8Z@IBMMAIL
IBMLink™	GDLVME(PUBRCF)

Be sure to include the name of the book, the form number (including the suffix), and the page, section title, or topic you are commenting on.

- Fill out the form at the back of this book and return it by mail, by fax, or by giving it to an IBM representative.

Issuing Commands

The RSCS commands start on page 7; Data Interchange Manager (RSCS Interchange) commands start on page 75. The syntax, purpose, and authorized users for each command are shown. The following abbreviations describe the authorization levels:

User	Meaning
C	RSCS console operator
S	System-authorized alternate operator
L	Link-authorized alternate operator
R	Remote printer or workstation operator
G	General user of Virtual Machine/Enterprise Systems Architecture (VM/ESA) or RSCS Interchange
P	Privileged RSCS Interchange users

RSCS Console Operator Commands (C): must, with certain exceptions, be preceded by the characters **RSCS**. For example:

```
rscs shutdown
```

This rule applies when the LOADCMD RSCS DMTMAN command is in effect for the operator's virtual machine. The exception is when another command is specified. For example, the statement:

```
LOADCMD ABCDE DMTMAN
```

indicates that each command must be preceded with the string **ABCDE**. For example:

```
abcde shutdown
```

System-Authorized Alternate Operator Commands (S): must be included in a CP SMSG command that contains the appropriate RSCS virtual machine identifier (RSCSID).

System-authorized alternate operators can enter any RSCS command; however, they must get additional authorization before issuing the CP command.

Link-Authorized Alternate Operator Commands (L): must be included in a CP SMSG command that contains the appropriate RSCS virtual machine identifier (RSCSID).

Remote Workstation Operator Commands (R): must never include the link ID in a command, with the following exceptions: CMD, MSG, and QUERY. A remote workstation operator can only enter those commands that affect their own links.

General VM User Commands (G): must be included in a CP SMSG command that contains the appropriate RSCS virtual machine identifier (RSCSID).

These keys indicate which commands are supported by each link type:

Key	Link
A	ASCII and TCPASCII links
D	Daemon links (LPD and UFTD)

Issuing Commands

Key	Link
N	NJE links (NJE, SNANJE, and TCPNJE)
PR	Printer links (LPR-, SNA3270P-, TN3270E-, and 3270P-)
SP	System processed command
U	UFT client link
W	Workstation links (MRJE, RJE, and SNARJE)

Presentation of Commands

The layout of commands in this book are presented as follows:

1

BAckspace²

User: C,L,R,S³

Links: A,PR,W⁴

VM/RSCS: Operation and Use, SH24-5220⁵

Restarts or repositions in a backward direction the file currently being transmitted.⁶

7

▶▶ **BAckspace** ⁽¹⁾ *linkid* File
nnn ▶▶

Note:

¹ If you are entering this command from a remote workstation, omit *linkid*. However, all other operators must specify the *linkid*.⁸

Key	Definition
1	Command line separator
2	Commands in alphabetic order
3	Users who can issue this command. For a list of users, see "Issuing Commands" on page 1.
4	Link types for which this command can be used. For a list of link types, see "Issuing Commands" on page 1.
5	Reference book name and order number where you may find more information. For a list of reference book names and numbers, see "Related Publications" on page 3.
6	A brief description
7	Syntax, with operands and options
8	Syntax note(s), if any

Understanding Syntax

Related Publications

This reference summary contains command and statement syntax diagrams that were extracted from the following publications:

- *VM/RSCS: Planning and Installation*, SH24-5219
- *VM/RSCS: Operation and Use*, SH24-5220
- *VM/RSCS: Diagnosis Reference*, SC24-5881
- *VM/RSCS: Data Interchange Manager Installing, Managing, and Using*, SH24-5248

It is intended only as a *quick reference aid* to help you use RSCS and RSCS Interchange. The basic document is the authoritative source and should be checked when additional or detailed information is needed.

Understanding Syntax Diagrams

To read a syntax diagram, follow the path of the line. Read from left to right and top to bottom.





- The ►— symbol indicates the beginning of a syntax diagram.
- The —► symbol, at the end of a line, indicates that the syntax diagram continues on the next line.
- The ►— symbol, at the beginning of a line, indicates that a syntax diagram continues from the previous line.
- The —◄ symbol indicates the end of a syntax diagram.

Syntax items (for example, a keyword or variable) may be:

- Directly on the line (required)
- Above the line (default)
- Below the line (optional).

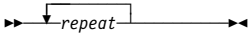
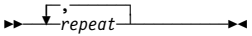
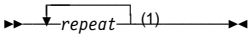
Syntax Diagram Description	Example
<p>Abbreviations: Uppercase letters denote the shortest acceptable abbreviation. If an item appears entirely in uppercase letters, it cannot be abbreviated.</p> <p>You can type the item in uppercase letters, lowercase letters, or any combination.</p> <p>In this example, you can enter KEYWO, KEYWOR, or KEYWORD in any combination of uppercase and lowercase letters.</p>	<p>►—KEYWOrd—◄</p>

Understanding Syntax

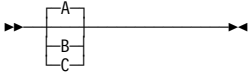
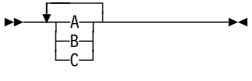
Syntax Diagram Description	Example
<p>Symbols: You must code these symbols exactly as they appear in the syntax diagram.</p>	<p>* Asterisk : Colon , Comma = Equal Sign - Hyphen () Parentheses . Period</p>
<p>Variables: Highlighted lowercase items (<i>like this</i>) denote variables. In this example, <i>var_name</i> represents a variable you must specify when you code the KEYWORD command.</p>	<p>▶▶KEYWORD—<i>var_name</i>▶▶</p>
<p>Repetition: An arrow returning to the left means that the item can be repeated. A character within the arrow means you must separate repeated items with that character. A footnote (1) by the arrow references a limit that tells how many times the item can be repeated.</p>	<p>▶▶▶▶</p> <p>▶▶▶▶</p> <p>▶▶▶▶</p> <p>Note: 1 Specify <i>repeat</i> up to 5 times.</p>
<p>Required Choices: When two or more items are in a stack and one of them is on the line, you <i>must</i> specify one item. In this example, you must choose A, B, or C.</p>	<p>▶▶▶▶</p>
<p>Optional Choice: When an item is below the line, the item is optional. In this example, you can choose A or nothing at all. When two or more items are in a stack below the line, all of them are optional. In this example, you can choose A, B, C, or nothing at all.</p>	<p>▶▶▶▶</p> <p>▶▶▶▶</p>
<p>Defaults: Defaults are above the line. The system uses the default unless you override it. You can override the default by coding an option from the stack below the line. In this example, A is the default. You can override A by choosing B or C.</p>	<p>▶▶▶▶</p>
<p>Repeatable Choices: A stack of items followed by an arrow returning to the left means that you can select more than one item or, in some cases, repeat a single item. In this example, you can choose any combination of A, B, or C.</p>	<p>▶▶▶▶</p>

Understanding Syntax

Syntax Diagram Description

Syntax Fragments:

Some diagrams, because of their length, must fragment the syntax. The fragment name appears between vertical bars in the diagram. The expanded fragment appears in the diagram after a heading with the same fragment name.

In this example, the fragment is named "A Fragment."

Example

▶▶| A Fragment |◀◀

A Fragment:



Understanding Syntax

* (Comment)

RSCS Commands

* (Comment)

User: C,G,L,R,S
Links: SP

VM/RSCS: Operation and Use, SH24-5220

Comment following asterisk prints out on the RSCS operator's console, but no function is performed.

▶▶*┌──────────────────┐▶▶
└comment_text┘

BACKSPACE

User: C,L,R,S
Links: A,PR,W

VM/RSCS: Operation and Use, SH24-5220

Restarts or repositions in a backward direction the file currently being transmitted.

▶▶Backspace(1)linkid┌File┐▶▶
└nnn┘

Note:

¹ If you are entering this command from a remote workstation, omit *linkid*. However, all other operators must specify the *linkid*.

CHANGE

CHANGE

User: C,G,L,R,S
Links: SP

VM/RSCS: Operation and Use, SH24-5220

Alters one or more attributes of an inactive spool file.

VM User Format:

► Change (1) linkid [spoolid] | Change Options |◄

Note:

¹ linkid is specified by link-authorized alternate operators only.

Operator Format:

► Change (1) linkid [ALL | CLASS c | FOR * nodeid * userid | FROM * nodeid * userid | HOLD | spoolid] [NOLoop] | Change Options |◄

Note:

¹ If you are entering this command from a remote workstation, omit linkid. However, all other operators must specify the linkid.

Select at least one of the following options for either format:

Change Options:

(1, 2) [CHars name (3)] [Class c] [COpy * nnn] [DEST ccccccc | OFF] [Dist distcode] [FCB name] [FLash name 0 | nnn] [FOrm ccccccc] [HOld | NOHold] [MOdify name 0 | trc] [NOPreflink] [PRIority nn] [NAme fn | ft | dsname]

Notes:

- ¹ Operands can be entered in any order, except the NAME must be the rightmost operand.
- ² At least one option must be specified.
- ³ CHARS can be specified up to 4 times.

CMD

CMD

User: C,G,L,R,S
Links: N

VM/RSCS: Operation and Use, SH24-5220

Sends a command line to a remote system for execution.

▶▶—CMD—*nodeid*—└─*command_text*—▶▶

CP

User: C,S
Links: SP

VM/RSCS: Operation and Use, SH24-5220

Executes a command line as a CP console function. System-authorized alternate operators require additional authorization for this command.

▶▶—CP—*command_text*—▶▶

CPQUERY

User: C,G,L,R,S
Links: SP

VM/RSCS: Operation and Use, SH24-5220

Requests status information from CP, similar to a CP QUERY command.

▶▶—CPQuery—┬─CPLLEVEL—▶▶
├─CPUid
├─Files
├─INDicate
├─LOGmsg
├─Names
├─Time
└─Users └─*userid*

CRI PREFIX

CRI PREFIX

User: C,G,L,R,S

VM/RSCS: Operation and Use, SH24-5220

A command prefix that lets you tell RSCS how to format command responses.



DEFINE

User: C,S

Links: SP

VM/RSCS: Operation and Use, SH24-5220

Temporarily adds a new link definition to the RSCS link table or temporarily alters an existing link definition.

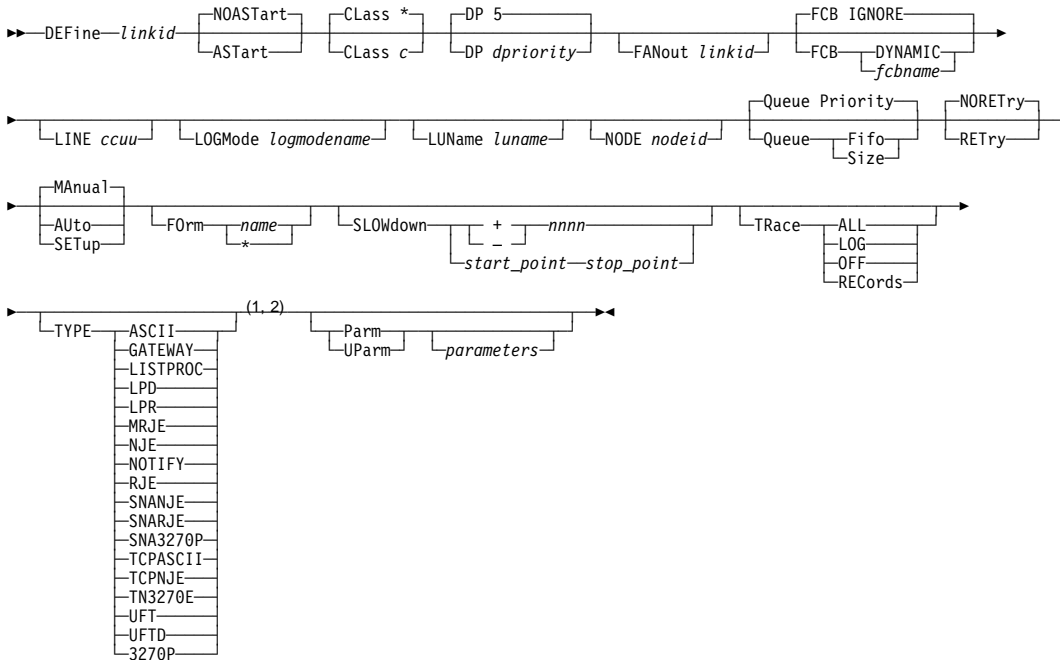

Notes:

- Options can be specified in any order. If PARM or UPARMS is specified, it must be the rightmost operand.
- PARM without parameters negates all previously defined parameters.

DELETE

DELETE

User: C,S
Links: SP

VM/RSCS: Operation and Use, SH24-5220

Temporarily deletes a link definition from the RSCS link table.

▶▶—DELEte—*linkid*—▶◀

DEST

User: C,S
Links: SP

VM/RSCS: Operation and Use, SH24-5220

Temporarily adds or deletes local Print Services Facility (PSF) printer destinations.

▶▶—DEST—

┌	ADD	┐	<i>destid</i>	▶◀
└	DELEte	┘		

DISABLE

User: C,S
Links: SP

VM/RSCS: Operation and Use, SH24-5220

Deactivates a switched telecommunication port (a dialed telephone line); incoming calls will not be received.

▶▶—DISAb1e—

┌	<i>ccuu</i>	┐	▶◀
└	ALL	┘	

DISCONNECT

DISCONNECT

User: C,S

Links: SP

VM/RSCS: Operation and Use, SH24-5220

Places RSCS in disconnect mode and optionally directs RSCS operator console output to another virtual machine.

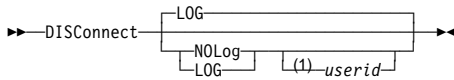

Note:

¹ If *userid* is specified, LOG or NOLOG must also be specified.

DRAIN

User: C,L,R,S,

Links: A,D,N,PR,U,W

VM/RSCS: Operation and Use, SH24-5220

Quiesces file transfer and deactivates an active data link.

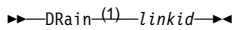

Note:

¹ If you are entering this command from a remote workstation, omit *linkid*. However, all other operators must specify the *linkid*.

ENABLE

User: C,S

Links: SP

VM/RSCS: Operation and Use, SH24-5220

Starts a switched telecommunication port (a dialed telephone line) and allows it to receive an incoming dialed call.

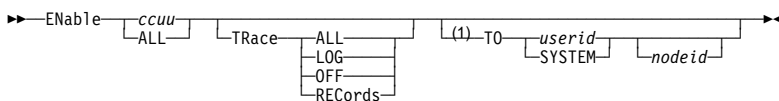

Note:

¹ If TO is specified, it must be the rightmost operand.

EXEC

EXEC

User: C,S
Links: SP

VM/RSCS: Operation and Use, SH24-5220

Executes a series of commands contained in the specified user-built CMS file (file type: GCS).

▶▶ Exec *filename* arguments ▶▶

EXIT

User: C,S
Links: SP

VM/RSCS: Operation and Use, SH24-5220

Enables or disables one or more specified exit points.

▶▶ EXIT ADDRESS sign hex_address ON
ALL OFF ▶▶
NAME name
NUMBER sign nnn

FLUSH

FLUSH

User: C,G,L R,S
Links: A,N,PR,U,W

VM/RSCS: *Operation and Use*, **SH24-5220**

Stops processing the currently active file on the specified link.

VM User Format:

```
▶▶—Flush—(1)—linkid—spoolid—▶▶  
                  *spoolid          ALL  
                                      HOLD
```

Note:

¹ *linkid* is specified by link-authorized alternate operators only.

Operator Format:

```
▶▶—Flush—(1)—linkid—spoolid—▶▶  
                  *                  ALL  
                                      HOLD
```

Note:

¹ If you are a link-authorized alternate operator entering this command from a remote workstation, omit *linkid*.

FORCE

User: C,S,
Links: A,D,N,PR,U,W

VM/RSCS: *Operation and Use*, **SH24-5220**

Immediately deactivates an active link without quiescing file transfer and is not valid with SNA links.

```
▶▶—FORCE—linkid—▶▶
```

FREE

User: C,L,
Links: A,N,PR

VM/RSCS: *Operation and Use*, **SH24-5220**

Resumes transmission or reception on a data link previously in hold status.

```
▶▶—Free—(1)—linkid—▶▶
```

Note:

¹ If you are entering this command from a remote workstation, omit *linkid*. However, all other operators must specify the *linkid*.

FWDSpace

FWDSpace

User: C,L,P,R,S
Links: A,W

VM/RSCS: Operation and Use, SH24-5220

Repositions, in a forward direction, the file currently being transmitted.

▶▶ FWdspace (1) linkid

1
nnn

 ▶▶

Note:

¹ If you are entering this command from a remote workstation, omit *linkid*. However, all other operators must specify the *linkid*.

HOLD

User: C,L,R,S,
Links: A,N,PR,U,W

VM/RSCS: Operation and Use, SH24-5220

Suspends file transmission and reception on an active link without deactivating the link.

▶▶ HOld (1) linkid

IMMEDiate
INPUT

 ▶▶

Note:

¹ If you are entering this command from a remote workstation, omit *linkid*. However, all other operators must specify the *linkid*.

INIT

User: C,S
Links: SP

VM/RSCS: Operation and Use, SH24-5220

Initiates RSCS operations.

▶▶ INIT ▶▶

ITRACE

ITRACE

User: C,S

Links: SP

VM/RSCS: Operation and Use, SH24-5220

Starts, stops, or changes the types of events RSCS will trace.

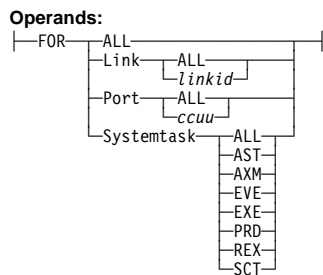
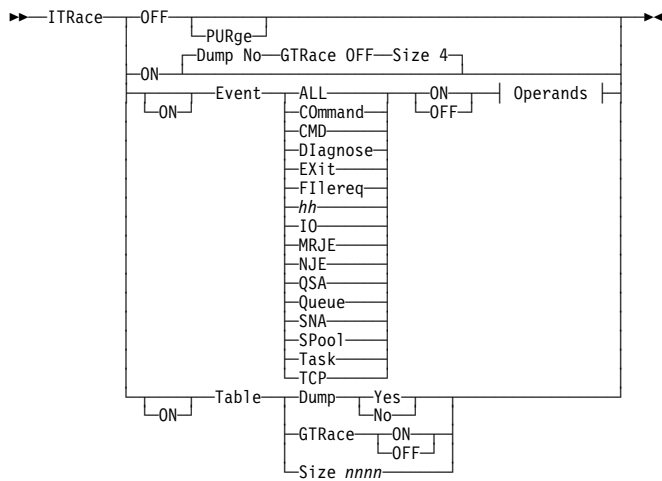

LOOPING

User: C,L,R,S

Links: SP

VM/RSCS: Operation and Use, SH24-5220

Defines what type of route loop checking, if any, RSCS should perform.



MSG

MSG

User: C,G,L,R,S
Links: A,N,PR,W

VM/RSCS: Operation and Use, SH24-5220

Sends a message to a local or remote operator or user.

(Valid for all links listed above except for LPR-type links.)

```
▶▶-Msg-nodeid-SYSTEM-userid-msgtext-▶▶
```

NETWORK

User: C,S
Links: SP

VM/RSCS: Operation and Use, SH24-5220

Starts or stops communications with ACF/VTAM (VTAM).

```
▶▶-Network-HALT-QUICK-Start Options-(1,2)-▶▶  
|  
-STArt-  
-TRace-ALL-LOG-OFF-TO-userid-nodeid-
```

Start Options:

```
|  
-APPLid name-(3)-Pass password-RETry nn-RETry 3-RPLs nnnnnn-RPLs 100-TRace-ALL-LOG-|
```

Notes:

- 1 If TO is specified, it should be the rightmost operand.
- 2 If TO is not specified, the log output file to the printer on the local system is used.
- 3 If APPLID is not specified, the name defaults to the APPLID specified in the LOCAL statement.

ORDER

ORDER

User: C,L,R,S
Links: SP

VM/RSCS: Operation and Use, SH24-5220

Reorders files queued on a specific link.

►►—ORDer—(1)—linkid—↓—spoolid—◄◄

Note:

¹ If you are entering this command from a remote workstation, omit *linkid*. However, all other operators must specify the *linkid*.

PORT

User: C,S
Links: SP

VM/RSCS: Operation and Use, SH24-5220

Connects or disconnects a port to the public switched telephone network and specifies whether an auto-dial or auto-answer link can use the port.

►►—PORT—ccuu—

DIAL
NODIAL
OFF

—◄◄

PURGE

PURGE

User: C,G,L,R,S
Links: SP

VM/RSCS: *Operation and Use*, SH24-5220

Removes specified files from a link.

VM User Format:

►►PURge⁽¹⁾linkid [spoolid] [*spoolid]

Note:

¹ linkid is specified by link-authorized alternate operators only.

Operator Format:

►►PURge⁽¹⁾linkid ALL
CLASS c
FOR [nodeid] [userid]
FROM [nodeid] [userid]
HO1d
[spoolid]

Note:

¹ If you are a link-authorized alternate operator entering this command from a remote workstation, omit linkid.

QUERY

QUERY

User: C,G,L,R,S

Links: SP

VM/RSCS: Operation and Use, SH24-5220

Requests information about files, groups, links, nodes, or the RSCS system. In the following diagrams, *fltr* means *filters* and *opt* means *options*.

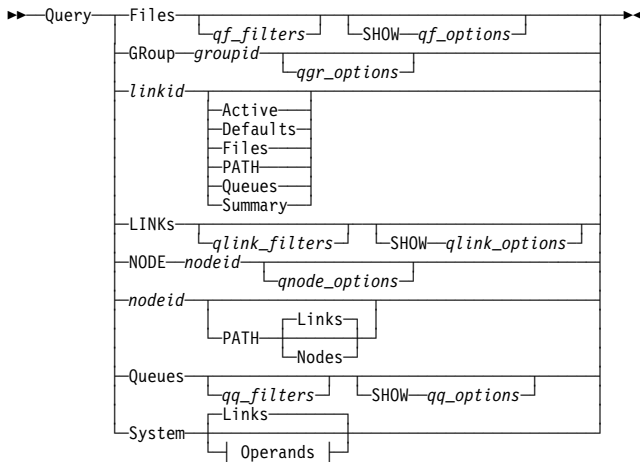

Operands:

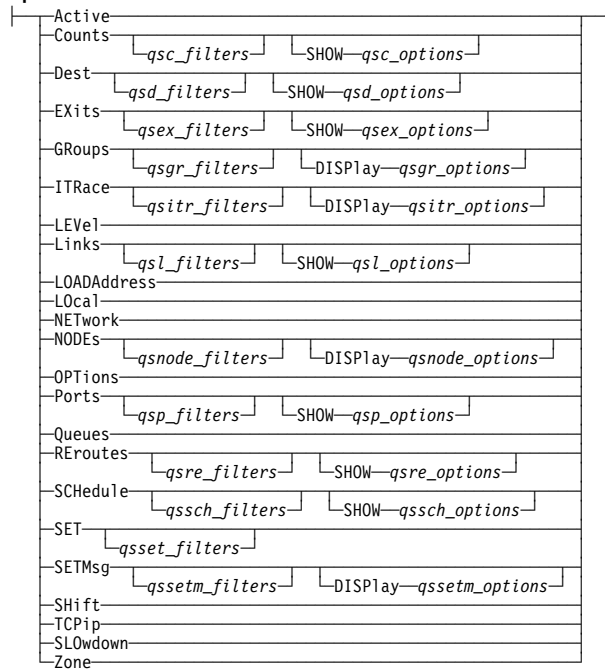

QUERY

Filters for Query Files

ACTive	BLocks <i>sign size</i>	CLass <i>c</i>
DEST <i>destname</i>	DIST <i>code</i>	FILEName <i>filename</i>
FILEType <i>filetype</i>	FN <i>filename</i>	FROM <i>nodeid userid</i>
FOrm <i>formname</i>	FT <i>filetype</i>	HOLD
INActive	INgroup <i>groupid</i>	LOOPing
NAME <i>fn ft</i>	NOHold	NOPROP
OFOrm <i>formname</i>	ON <i>linkid</i>	OSPId <i>sign spoolid</i>
PRINTer	PRiority <i>sign nn</i>	PRT
PUNCh	RECEiving	RECords <i>sign num</i>
SENDing	SPECHold	SPId <i>sign spoolid</i>
TO <i>nodeid userid</i>		

Show Options for Query Files

ACcmsg	BASE	BLOCKs
BLOCKSDone	CHAR0	CHAR1
CHAR2	CHAR3	CLass
COPIes	COpy	COUNT
DEST	DESTInfo	DEVice
DIST	DSName	ENQmsg
FCB	FILEInfo	FILEName
FILEType	FINalmsg	FLash
FN	FOrm	FROMNode
FROMQual	FROMUser	FT
FULL	HOLD	ID
LOOPing	MODify	MSGInfo
NONE	OFOrm	ORDered
ORIGID	ORIGInfo	OSPId
OTIme	OVerridenode	PREFlink
PREVNode	PRiority	PROGRESS
PROGRESSBlocks	PRTInfo	QInfo
RECords	RECSDone	RERouted
Rscs	SANDFwd	SEntmsg
SPId	STATInfo	STatus
TOInfo	TONode	TOUser
Vm	3800Info	

Options for Query Group

Files	Groups	Hierarchy
Links	Nodes	Parentgroup
Rootgroup		

QUERY

Options for Query Linkid

Active	Defaults	Files
PATH	Queues	Summary

Filters for Query Links and Query System Links

ACTIVE	ASTart	AUto
CLASS <i>c</i>	CONNECT	Dialque
DP <i>sign nn</i>	DRAin	FANout <i>linkid</i>
FIFO	Form <i>formname</i>	HELD <i>sign nnnn</i>
Hold	INActive	INPuthold
INTreq	LINE <i>sign ccuu</i>	LOGMode <i>logmode</i>
LOOPing <i>sign nnnn</i>	LUName <i>luname</i>	MANual
NAME <i>linkid</i>	NETworking	NOASTart
NOCONNECT	NODE <i>nodeid</i>	NODrain
NOHold	NOINActive	NONNETworking
NONSNA	NOTRace	OUTPuthold
PRiority	Queued <i>sign nnnn</i>	RECeiving <i>sign nnnn</i>
RELEased	RETrying	RETRYOption
SENDing <i>sign nnnn</i>	SETup	SIZE
SLOWDElta <i>sign nnnn</i>	SLOWSTArt <i>sign nnnn</i>	SLOWSTOP <i>sign nnnn</i>
SLOWUNique	SNA	STARTing
TRace	TCPIP	TYPE <i>type</i>
WAITForm		

Show Options for Query Links and Query System Links

ACTIVE	ASTart	BASE
BUFFersize	Class	COUNTs
DEFault	DEFClass	DEFDP
DEFLINE	DEFLOGMode	DEFLUName
DEFPARM	DEFPARFull	DEFQType
DEFTYPE	DP	DRAin
FANout	FCBInfo	FCBMode
FCBName	Form	FULL
HELD	HOLD	ID
LINE	LOGMode	LOOPing
LUName	MMode	NAME
NODE	NONE	OPARM
OPARFull	PARM	PARMFull
QType	Queued	RECeiving
RETRIEDone	RETRYInfo	RETRYINterval
RETRYOption	SENDing	SLOWDElta
SLOWdown	SLOWSTArt	SLOWSTOP
SLOWMMode	STatus	TRace
TYPE	UPARM	UPARFull

QUERY

Options for Query Node

Links	Parentgroup	PATH
Rootgroup		

Filters for Query Queues

ACTIVE	BLocks <i>sign size</i>	CLass <i>c</i>
DEST <i>destname</i>	DIST <i>code</i>	EXITHold
FILEName <i>filename</i>	FILEType <i>filetype</i>	FN <i>filename</i>
FOrm <i>formname</i>	FROM <i>nodeid userid</i>	FT <i>filetype</i>
HOLD	INActive	INgroup <i>groupid</i>
LOOPing	NAME <i>fn ft</i>	NOHold
NOPROP	OFOrm <i>formname</i>	ON <i>linkid</i>
OSPId <i>sign spoolid</i>	POSinq <i>sign nnnn</i>	PRINTer
PRiority <i>sign nn</i>	PRT	PUNCh
RECEiving	RECOords <i>sign num</i>	SENDing
SPECHOLD	SPId <i>sign spoolid</i>	TO <i>nodeid userid</i>

Show Options for Query Queues

ACcmsg	BASE	BLOCKs
BLOCKSDone	CHAR0	CHAR1
CHAR2	CHAR3	CLass
COpies	COpy	COUNT
DEST	DESTInfo	DEVice
DIST	DSName	ENQmsg
FCB	FILEInfo	FILEName
FILEType	FINAlmsg	FLash
FN	FOrm	FROMNode
FROMQual	FROMUser	FT
FULL	HOLD	ID
LINK	LOOPing	MODify
MSGInfo	NONE	OFOrm
ORDered	ORIGID	ORIGInfo
OSPId	OTIme	OVerridenode
POSinq	PREFInk	PREVNode
PRiority	PROGRESS	PROGRESSBlocks
PRTInfo	QInfo	RECOords
RECSDone	RERouted	Rscs
SANDFwd	SEntmsg	SPId
STATInfo	SStatus	TOInfo
TONode	TOUser	Vm
3800Info		

QUERY

Filters for Query System Counts

FILEIn <i>sign nnnnnnnn</i>	FILEINKbytes <i>sign nnnnnnnn</i>	FILEOut <i>sign nnnnnnnn</i>
FILEOUTKbytes <i>sign nnnnnnnn</i>	IO <i>sign nnnnnnnn</i>	IOERRors <i>sign nnnnnnnn</i>
LINEIOTime <i>sign: nnnnnnnn</i>	LINK <i>linkid</i>	MSGIn <i>sign nnnnnnnn</i>
MSGINKbytes <i>sign nnnnnnnn</i>	MSGOut <i>sign nnnnnnnn</i>	MSGOUTKbytes <i>sign nnnnnnnn</i>
NETworking	NODE <i>nodeid</i>	NONNETworking
NONSNA	RPLRc <i>sign nnnn</i>	RPLSense <i>sign nnnn</i>
RPLUSense <i>sign nnnn</i>	SNA	SPReads <i>sign nnnnnnnn</i>
SPREADTime <i>sign nnnnnnnn</i>	SPWrites <i>sign nnnnnnnn</i>	SPWRITETime <i>sign nnnnnnnn</i>
TIMEOuts <i>sign nnnnnnnn</i>	TCPIP	

Show Options for Query System Counts

BASE	Kbytes	FILEIn
FILEINKbytes	FILEOut	FILEOUTKbytes
FULL	IO	IOERRors
IOTime	LINEIOTime	LINK
MSGIn	MSGINKbytes	MSGOut
MSGOUTKbytes	NONE	RPLRc
RPLR0	RPLR15	RPLSense
RPLUSense	SINCE	SNAInfo
SPReads	SPREADTime	SPWrites
SPWRITETime	Status	STREAMS
STREAM1	STREAM2	STREAM3
STREAM4	STREAM5	STREAM6
STREAM7	STREAM8to32	SUMmary
TIMEOuts	VTAMRequest	

Filters for Query System Dest

NAME *name*

Show Options for Query System Dest

BASE	FULL	NAME
NONE		

Filters for Query System Exits

ADDRESS <i>sign hex-address</i>	NAME <i>name</i>	NUMBER <i>sign exitnumber</i>
OFF	ON	

QUERY

Show Options for Query System Exits

ADDRess	BASE	FULL
NAME	NONE	NUMber
STatus		

Filters for Query System Groups

Alternatelink <i>linkid</i>	Bottomlevel	GRoup <i>groupid</i>
INgroup <i>groupid</i>	NAME <i>groupid</i>	NODE <i>nodeid</i>
Primarylink <i>linkid</i>	Root	Toplevel

Display Options for Query System Groups

Files	Groups	Links
Nodes	Parentgroup	Rootgroup

Filters for Query System Itrace

LINK <i>linkid</i>	Port <i>sign ccuu</i>	Systemtask <i>task</i>
Table		

Display Options for Query System Itrace

ALL	COMmand	CMD
Dlagnose	EXit	Flerequest
IO	MRJE	NJE
QSA	Queue	SNA
SPool	Task	TCPip

Filters for Query System Nodes

Alternatelink <i>linkid</i>	INgroup <i>groupid</i>	NAME <i>nodeid</i>
Primarylink <i>linkid</i>		

Display Options for Query System Nodes

Links	Parentgroup	Rootgroup
--------------	--------------------	------------------

QUERY

Filters for Query System Ports

Dial LINE <i>sign ccuu</i> TRace	DISabling LINK <i>linkid</i> NOTRace	FRee NODial Used
---	---	-------------------------------

Show Options for Query System Ports

BASE LINE SStatus	Dial LINK TRace	FULL NONE
--------------------------------	------------------------------	---------------------

Filters for Query System Reroutes

ALL FILEOnly MSGOnly Quiet	Cmnds FOR <i>nodeid userid</i> NOQuiet TO <i>nodeid userid</i>	Files Msgs NOTrcvg
--	--	---------------------------------

Show Options for Query System Reroutes

BASE FORUser Quiet TOUser	FOR FULL TO TYPE	FORNode NONE TONode
---	----------------------------------	----------------------------------

Filters for Query System Schedule

ACTive DAYs <i>string</i> INTernal SYStem TIME <i>hh:mm</i>	ALL EXTernal LOWRange <i>hh:mm</i> TASKid <i>sign nnn</i> User	DATE <i>yy/mm/dd</i> HIGHRange <i>hh:mm</i> SUSPended TASKName <i>name</i>
--	---	--

Show Options for Query System Schedule

BASE DAYs NONE TASKid TYPE	Command FULL Range TASKName	DATE FULLCommand SStatus TIME
---	---	---

READY

Filters for Query System Set

FOR *nodeid userid* LINK *linkid* *

Filters for Query System Setmsg

FOR *nodeid userid* MSG *sign nnn*

Display Options for Query System Setmsg

ALL *nnn*

READY

User: C,L,R,S
Links: A,PR,W

VM/RSCS: Operation and Use, SH24-5220

Notifies RSCS that a forms mount has been satisfied or that a setup page is wanted.

(Valid for all links listed above except for TN3270E-type links.)

►►Ready⁽¹⁾linkid◄◄

Note:

¹ If you are entering this command from a remote workstation, omit *linkid*. However, all other operators must specify the *linkid*

RECONNECT

User: C,S
Links: SP

VM/RSCS: Operation and Use, SH24-5220

Takes RSCS out of disconnect mode.

►►REConnect◄◄

REORDER

REORDER

User: C,S
Links: SP

VM/RSCS: *Operation and Use*, SH24-5220

Sorts and reorders all files queued for all links.

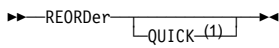

Note:

¹ If QUICK is not specified, a full reorder is performed.

REPLY

User: C,G,L,R,S
Links: SP

VM/RSCS: *Operation and Use*, SH24-5220

Sends a message to the user that issued the command. When used within an exec, sends a message to the user that issued the exec.

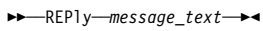

REROUTE

User: C,S
Links: SP

VM/RSCS: *Operation and Use*, SH24-5220

Modifies the original destination of commands, files, and messages for specific systems and user IDs.

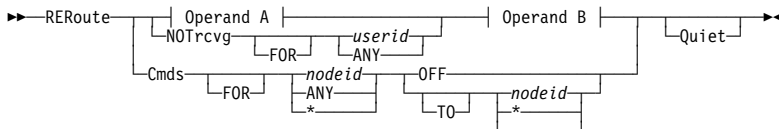

Operand A:

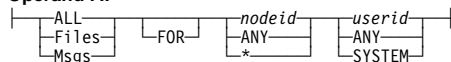

Operand B:

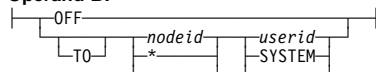

SCHEDULE

SCHEDULE

User: C,S

Links: SP

VM/RSCS: *Operation and Use*, SH24-5220

Temporarily adds, deletes, resumes, or suspends an event for the RSCS system.

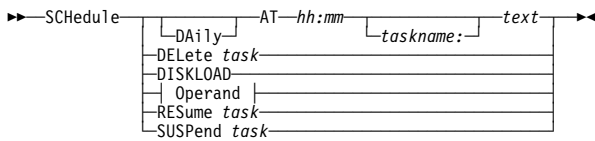

Operand:

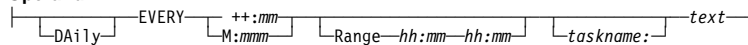

SET

User: C,L,S

Links: SP

VM/RSCS: *Operation and Use*, SH24-5220

Starts or stops the sharing of RSCS console messages based on link ID.

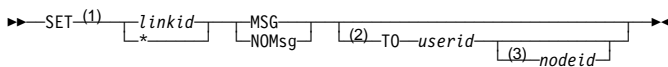

Notes:

- 1 Only authorized users can enter the *linkid* or ***.
- 2 If *TO userid* is not specified, console messages are sent to the operator entering the SET command. RSCS console operators *must* enter the TO operand when using the SET command.
- 3 If *nodeid* is not specified, console messages are sent to the specified *userid* of the local system.

SETMSG

User: C,S

Links: SP

VM/RSCS: *Operation and Use*, SH24-5220

Starts or stops the sharing of RSCS console messages based on the message number.

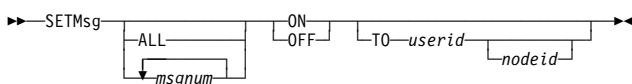

SHIFT

SHIFT

User: C,S
Links: SP

VM/RSCS: Operation and Use, SH24-5220

Changes the RSCS shift setting. RSCS exit routines can use this number to perform shift-dependent processing.

►►—SHIFT—*shift_number*—◄◄

SHUTDOWN

User: C,S
Links: A,D,N,PR,U,W

VM/RSCS: Operation and Use, SH24-5220

Terminates RSCS in an orderly manner, issuing a DRAIN or STOP command to each active link. (Optional) Also passes a command to CP for processing after RSCS terminates.

►►—SHUTDOWN—
┌—QUICK—┐ ┌—CP *cp_command*—┐ ◄◄

SLOWDOWN

User: C,S
Links: N

VM/RSCS: Operation and Use, SH24-5220

Tells RSCS when to automatically start or stop slowdown mode.

►►—SLOWdown—
┌—STArt *nnnn*—┐ ┌—STOp *nnnn*—┐ ◄◄
└—STOp *nnnn*—┐ └—STArt *nnnn*—┐

START

START

User: C,L,R,S

Links: SP

VM/RSCS: Operation and Use, SH24-5220

Starts a link or causes an active link to begin processing a specific class or form of files.

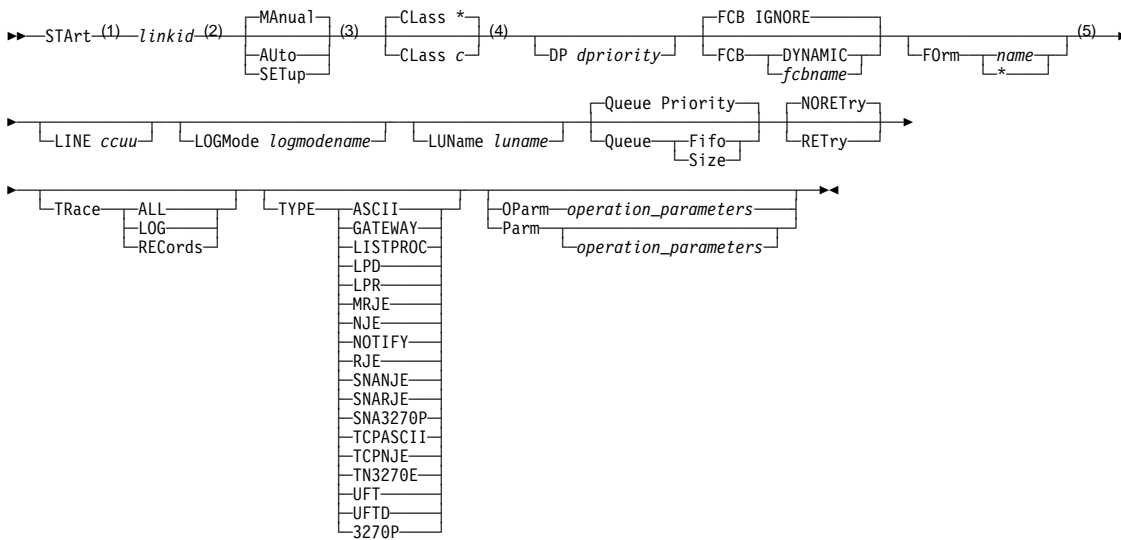

Notes:

- 1 If you are entering this command from a remote workstation, omit *linkid*. However, all other operators must specify the *linkid*.
- 2 Operands can be entered in any order, except the PARM or OPARM must be the rightmost operand.
- 3 If CLASS is not specified, the class definition in the link table entry is used.
- 4 DP is not specified, priority definition in the link table entry is used.
- 5 If LINE is not specified, an available switched port is used.

STOP

STOP

User: C,L,R,S
Links: SP

VM/RSCS: *Operation and Use*, SH24-5220

Terminates a specified link immediately.

►►—STOP—(1)—linkid—►►

Note:

¹ If you are entering this command from a remote workstation, omit *linkid*. However, all other operators must specify the *linkid*.

TCPIP

User: C,S
Links: SP

VM/RSCS: *Operation and Use*, SH24-5220

Start or stops the RSCS port redirector task.

►►—TCPIP—START—TRace—ALL—LOG—►►
►►—TCPIP—STOP—TRace—ALL—LOG—OFF—(1)—TO—userid—nodeid—►►

Note:

¹ If TO is not specified, the log output file to the printer on the local system is used.

TRACE

User: C,L,R,S
Links: SP

VM/RSCS: *Operation and Use*, SH24-5220

Monitors line activity on a specified link.

►►—TRace—(1)—linkid—LOG—ALL—NOLog—OFF—RECORDs—TO—userid—nodeid—►►

Note:

¹ If you are entering this command from a remote workstation, omit *linkid*. However, all other operators must specify the *linkid*.

TRANSFER

TRANSFER

User: C,G,L,R,S
Links: SP

VM/RSCS: Operation and Use, SH24-5220

Changes the destination address for specified files.

VM User Format:

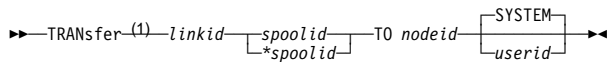

Note:

¹ `linkid` is specified by link-authorized alternate operators only.

Operator Format:

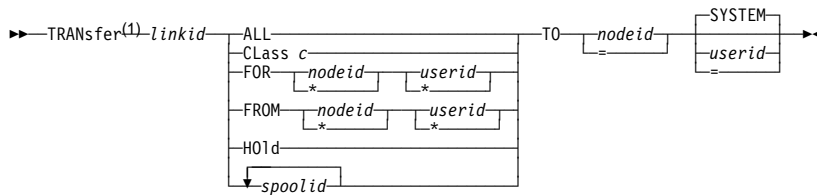

Note:

¹ If you are entering this command from a remote workstation, omit `linkid`. However, all other operators must specify the `linkid`.

Parameters for ASCII-Type Links

Link Operational Parameters

This section lists the link-dependent operational parameters (or parm values) for each type of link. Parm values can be supplied when a link is:

- Permanently defined using the PARM or UPARM statements,
- Temporarily defined or altered using the PARM or UPARM operands of the DEFINE command, or
- Started using the PARM or OPARM operands of the START command.

The format and content of the parm values is different for each type of link.

Parameters for ASCII-Type Links

VM/RSCS: Operation and Use, SH24-5220

To begin a session with a remote ASCII printer or plotter, an ASCII-type link must be started either:

- Automatically during system start-up
- Automatically when a file is queued for transmission on an auto-start link
- Manually by the operator

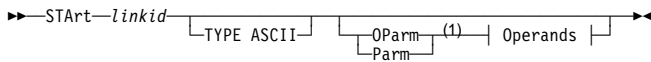

Operands:

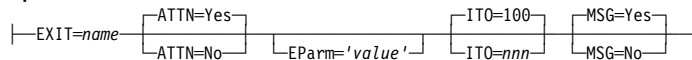

Note:

- ¹ After PARM or OPARM is specified, operands can be entered in any order, separated from each other by blanks.

Parameters for GATEWAY-Type Links

Parameters for GATEWAY-Type Links

VM/RSCS: Operation and Use, SH24-5220

A GATEWAY-type link is an installation-defined link that lets an installation customize a network gateway. The link may be started either manually by an operator, or automatically:

- During system start-up or
- When a file is queued for transmission on an auto-start link.

▶▶—STArt—linkid— [TYPE GATEWAY] [OParm (1) Operands]

Operands:

[EXIT=name] [EParm='value'] [JOBName= [Rscs Userid]] [LISTproc= [No Yes]] [MAXDsh=nnn] [MAXUro=2] [MAXUro=nnn]
 [OPTimize=Yes] [OPTimize=NO] [STreams=1] [STreams=nn] [TA=0] [TA=epname] [TAParm='value']

Note:

- 1 After PARM or OPARM is specified, operands can be entered in any order, separated from each other by blanks.

Parameters for LISTPROC-Type Links

VM/RSCS: Operation and Use, SH24-5220

A LISTPROC-type link is a list processor link which processes information to be distributed by the networking links. The link may be started either manually by an operator, or automatically:

- During system start-up or
- When a file is queued for transmission on an auto-start link.

▶▶—STArt—linkid— [TYPE LISTPROC] [OParm (1) Operands]

Operands:

[Buff=4096] [Buff=nnnnnn] [JOBName= [Rscs Userid]] [MAXUro=16] [MAXUro=nnn] [STreams=1] [STreams=n] [TA=0] [TA=epname] [TAParm='value']

Note:

- 1 After PARM or OPARM is specified, operands can be entered in any order, separated from each other by blanks.

Parameters for LPD-Type Links

Parameters for LPD-Type Links

VM/RSCS: Operation and Use, SH24-5220

An LPD-type link enables your local RSCS system to connect to a remote line printer client (LPR) within a TCP/IP network.

```
▶▶ START=linkid [TYPE LPD] [OParm=Parm (1) Operands]
```

Operands:

```
[EXIT=name] [EParm='value'] [TCPid=TCPIP] [P0rt=515] [TImeout=60]
[TCPid=tcip] [P0rt=portid] [TImeout=nnn]
```

Note:

- After PARM or OPARM is specified, operands can be entered in any order, separated from each other by blanks.

Parameters for LPR-Type Links

VM/RSCS: Operation and Use, SH24-5220

An LPR-type link enables your local RSCS system to connect to a remote line printer daemon (LPD) within a TCP/IP network.

```
▶▶ START=linkid [TYPE LPR] [OParm=Parm (1) Operands]
```

Operands:

```
[EXIT=name] [EParm='value'] [ITO=100] [TCPid=TCPIP] [P0rt=515] [PAss=2]
[ITO=nnn] [TCPid=tcip] [HOST=ipaddress] [P0rt=portid] [PAss=1]
[HOSTName=address]
[CT11st=No] [DNSPORT=900] [FILehold=No]
[CT11st=Yes] [PRinter=name] [DAYshold=nnn] [DNSPORT=portid] [FILehold=Yes] [HOSTDafn=name]
[SECure=Yes] [SIZE=0] [SYSTEM=No] [TImeout=0] [USER=No]
[SECure=No] [SIZE=nnn] [SYSTEM=Yes] [TImeout=nnn] [USER=Yes]
```

Note:

- After PARM or OPARM is specified, operands can be entered in any order, separated from each other by blanks.

Parameters for MRJE-Type Links

Parameters for MRJE-Type Links

VM/RSCS: Operation and Use, SH24-5220

An MRJE-type link is a workstation link. It can connect a system node (in HOST mode) to a workstation node. If the system node is acting as a workstation (in JES2, JES3, or RES mode), it can also connect to another system that is acting as the host.

The link may be started either manually by an operator, or automatically:

- During system start-up
- When a file is queued for transmission on an auto-start link
- When a call is received over an enabled (auto-answer) switched telecommunication line

If the link is not on an auto-answer line, the host side of the link must be started first, before a remote station can sign on.

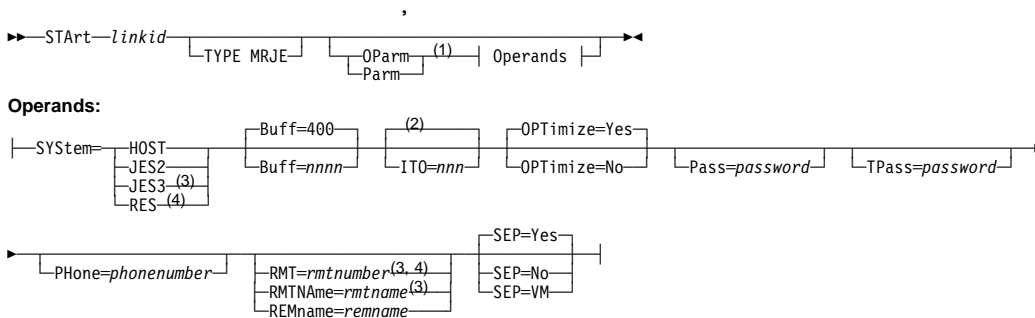

Notes:

- 1 After PARM or OPARM is specified, operands can be entered in any order, separated from each other by blanks.
- 2 The default value for ITO is 1 minute for a dialed link and 100 (active until deactivated manually or a nonrecoverable error occurs) for a link that is not dialed.
- 3 If `SYSTEM=JES3` is specified, then either RMT or RMTNAME must also be specified.
- 4 If `SYSTEM=RES` is specified, then RMT must also be specified.

Parameters for NJE-Type Links

Parameters for NJE-Type Links

VM/RSCS: Operation and Use, SH24-5220

NJE-type links communicate with one remote system node. Each link controls one communication adapter for a BSC line, a CTCA, an ESCON CTCA, or a 3088 communication unit.

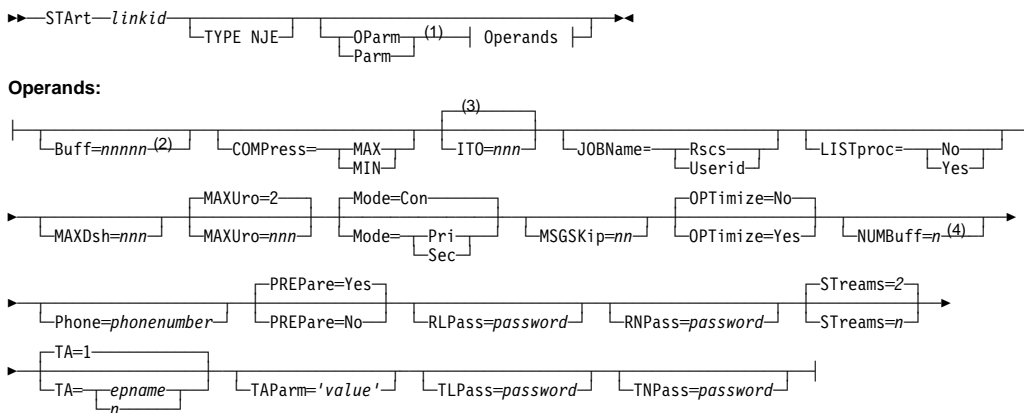

Notes:

- 1 After PARM or OPARM is specified, operands can be entered in any order, separated from each other by blanks.
- 2 The default for BUFF is 800 for a BSC line and 4096 for a CTCA, ESCON CTCA, or 3088.
- 3 The default value for ITO is 1 minute for a dialed link and 100 (active until deactivated manually or a nonrecoverable error occurs) for a link that is not dialed.
- 4 Whether you specify or omit NUMBUFF, each link gets 2 transmission buffers.

Parameters for NOTIFY-Type Links

VM/RSCS: Operation and Use, SH24-5220

NOTIFY-type links provide a service that generates notes, holds files, and purges files.

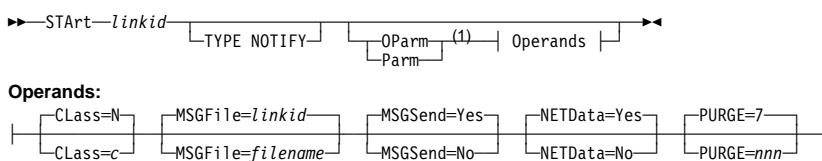

Note:

- 1 After PARM or OPARM is specified, operands can be entered in any order, separated from each other by blanks.

Parameters for RJE-Type Links

Parameters for RJE-Type Links

VM/RSCS: Operation and Use, SH24-5220

RJE-type links provide BSC line protocol only to a single remote job entry workstation. To complete RJE startup, you must send a SIGNON card from the workstation.

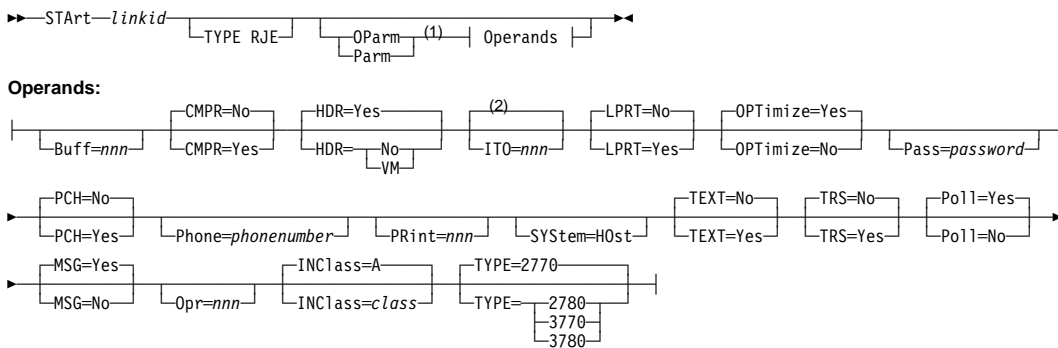

Notes:

- 1 After PARM or OPARM is specified, operands can be entered in any order, separated from each other by blanks.
- 2 The default value for ITO is 1 minute for a dialed link and 100 (active until deactivated manually or a nonrecoverable error occurs) for a link that is not dialed.

Parameters for SNANJE-Type Links

Parameters for SNANJE-Type Links

VM/RSCS: Operation and Use, SH24-5220

SNANJE-type links send files from a host VM system to an NJE system through VTAM in an SNA network using an LU_T0 session.

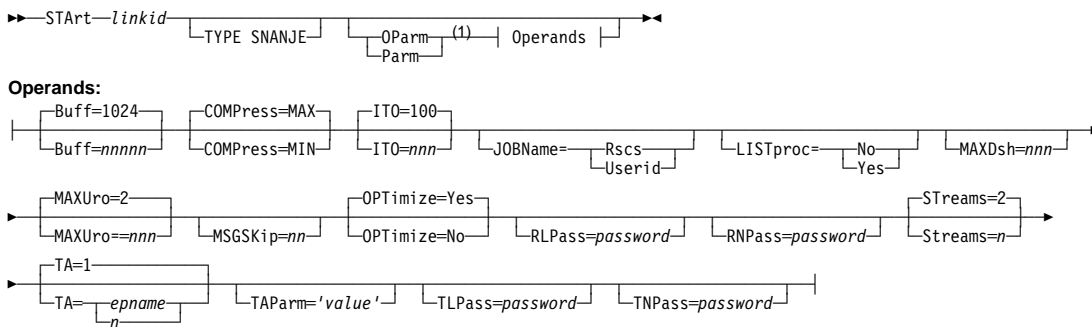

Note:

- 1 After PARM or OPARM is specified, operands can be entered in any order, separated from each other by blanks.

Parameters for SNARJE-Type Links

VM/RSCS: Operation and Use, SH24-5220

SNARJE-type links send files from a host VM system to an RJE workstation through VTAM in an SNA network using an LU_T1 session.

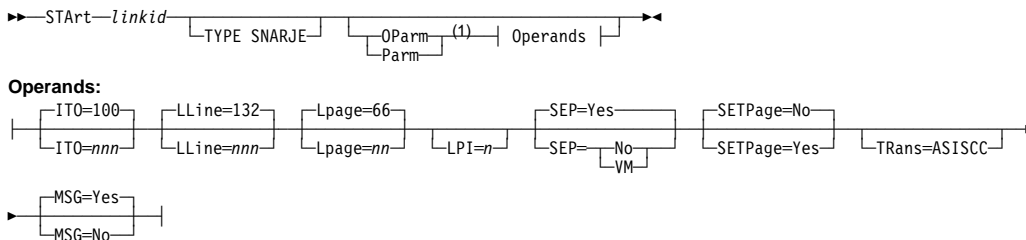

Note:

- 1 After PARM or OPARM is specified, operands can be entered in any order, separated from each other by blanks.

Parameters for SNA3270P-Type Links

Parameters for SNA3270P-Type Links

VM/RSCS: Operation and Use, SH24-5220

SNA3270P-type links send files from a host VM system to a 3270 printer through VTAM in an SNA network using LU_T0, LU_T1, or LU_T3 sessions.

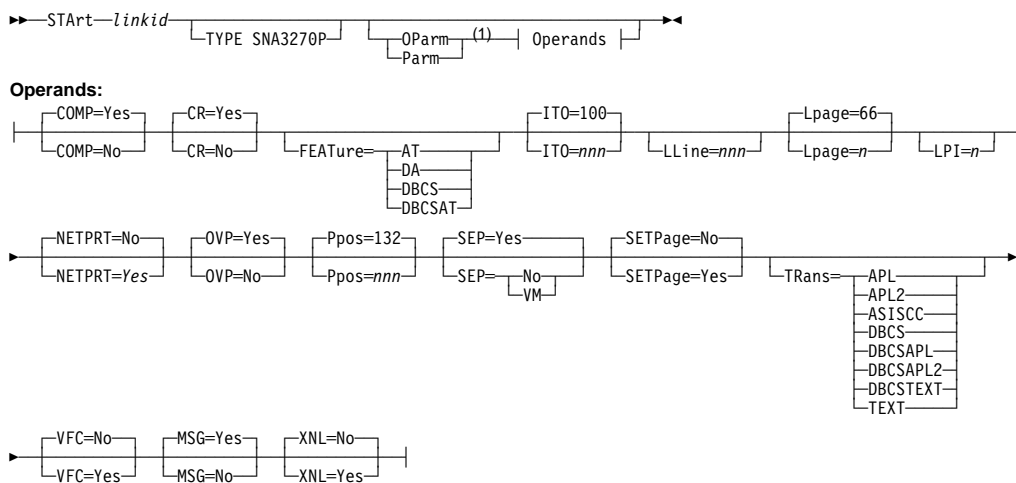

Note:

¹ After PARM or OPARM is specified, operands can be entered in any order, separated from each other by blanks.

Parameters for TCPASCII-Type Links

Parameters for TCPASCII-Type Links

VM/RSCS: Operation and Use, SH24-5220

TCPASCII-type links communicate with remote ASCII printers or plotters that are attached to a terminal server in a TCP/IP network. To begin a session, a TCPASCII-type link must be started:

- Automatically, during system start-up
- Automatically, when a file is queued for transmission on an auto-start link
- Manually, by the operator.

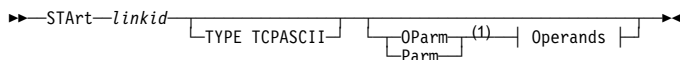

Operands:

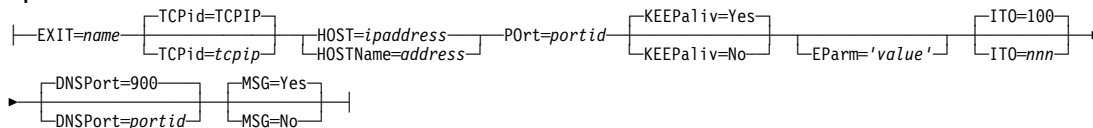

Note:

¹ After PARM or OPARM is specified, operands can be entered in any order, separated from each other by blanks.

Parameters for TCPNJE-Type Links

Parameters for TCPNJE-Type Links

VM/RSCS: Operation and Use, SH24-5220

A TCPNJE-type link is a link to a remote NJE system within a TCP/IP network. The link may be started:

- Automatically, during system start-up
- Automatically, when a file is queued for transmission on an auto-start link
- Manually, by an operator.

▶ START—linkid [TYPE TCPNJE] [OParm-Param (1) Operands] ▶

Operands:

[Buff=nnnnn] [COMPRESS=MIN] [COMPRESS=MAX] [ITO=100] [ITO=nnn] [JOBName=Rscs Userid] [LISTproc=No Yes] [MAXDsh=nnn]

[MAXUro=2] [MAXUro=nnn] [MSGSkip=nn] [NUMBuff=n] [OPTimize=No Yes] [TCPid=TCPIP tcPIP] [HOST=ipaddress HOSTName=address]

[LCLPORT=175] [LCLPORT=portid] [RMTPORT=175] [RMTPORT=portid] [KEEPAliv=Yes No] [RLPass=password] [RNPAss=password]

[STreams=2] [STreams=password] [TA=1] [TA=epname n] [TAParm='value'] [TLPass=password] [TNPass=password]

[DNSPORT=900] [DNSPort=portid]

Note:

¹ After PARM or OPARM is specified, operands can be entered in any order, separated from each other by blanks.

Parameters for UFT-Type Links

Parameters for UFT-Type Links

VM/RSCS: Operation and Use, SH24-5220

An UFT-type link enables your local RSCS system to connect to a remote UFT daemon (UFTD) within a TCP/IP network.

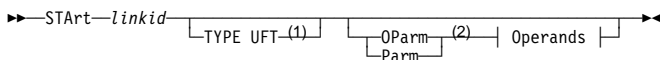

Operands:

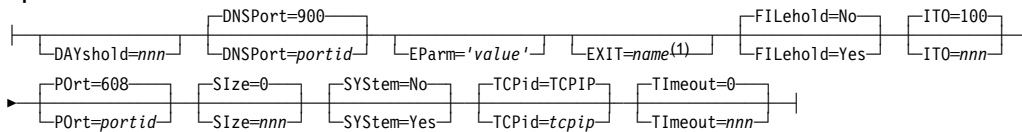

Notes:

- 1 If field was not previously defined for the link, this field must be specified.
- 2 After PARM or OPARM is specified, operands can be entered in any order, separated from each other by blanks.

Parameters for UFTD-Type Links

VM/RSCS: Operation and Use, SH24-5220

An UFTD-type link enables your local RSCS system to connect to a remote UFT client (UFT) within a TCP/IP network.

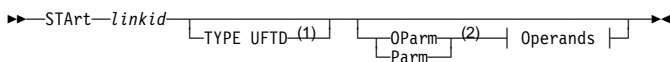

Operands:

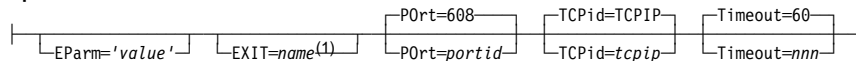

Notes:

- 1 If field was not previously defined for the link, this field must be specified.
- 2 After PARM or OPARM is specified, operands can be entered in any order, separated from each other by blanks.

Parameters for 3270P-Type Links

Parameters for 3270P-Type Links

VM/RSCS: Operation and Use, SH24-5220

3270P-type links send files from a host VM system to a local or remote 3270 Information Display System printer.

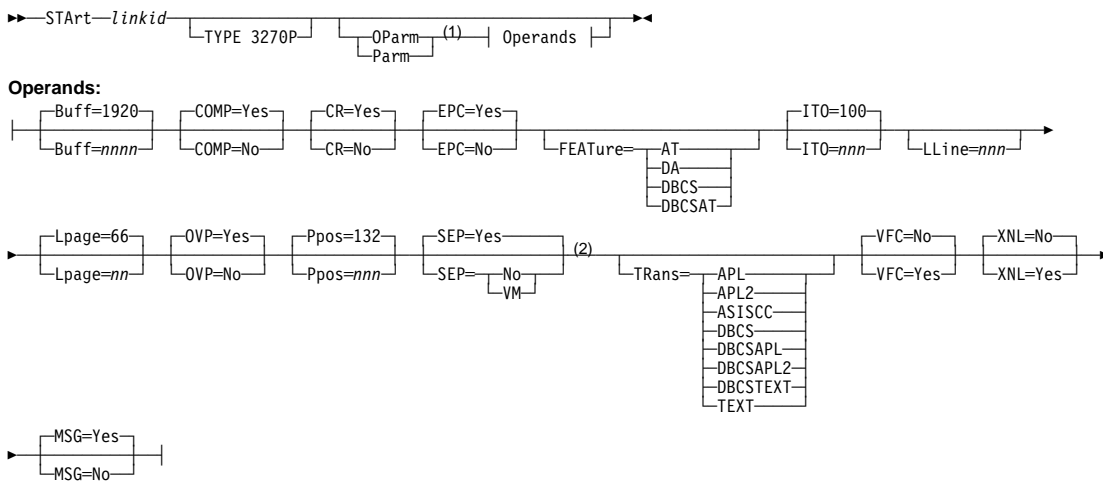

Notes:

- 1 After PARM or OPARM is specified, operands can be entered in any order, separated from each other by blanks.
- 2 If TRANS is not specified, usual character translation occurs.

Parameters for 3270P-Type Links

Comments

Configuration File Statements

The RSCS CONFIG contains statements used to initialize RSCS operation. When RSCS is IPLed, the contents of RSCS CONFIG are used in building the system control blocks.

All configuration file statements are optional. For each statement, the syntax, description, and the number of times it can be specified in the configuration file are shown.

Comments

No Limit

VM/RSCS: Planning and Installation, SH24-5219

Indicates a comment.

» * _____ «
 comment_text

» /* _____ */ «
 comment_text

AUTH

No Limit

VM/RSCS: Planning and Installation, SH24-5219

Identifies an authorized alternate operator for RSCS or for a specified link.

For a Link-Authorized Alternate Operator:

» AUTH—linkid—userid _____ «
 nodeid NOCP
 * *
 * *

For a System-Authorized Alternate Operator:

» AUTH—localid—userid _____ «
 * *
 nodeid NOCP
 * CP
 * *

CHANNELS

CHANNELS

One

VM/RSCS: Planning and Installation, SH24-5219

Reserves one or more channels for exclusive use by RSCS for its virtual device pool.

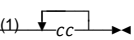
▶▶ CHANNELS (1) ▶▶

Note:

¹ If CHANNELS statement omitted, RSCS uses channel X'0F' for its virtual unit record device pool.

DEST

No Limit

VM/RSCS: Planning and Installation, SH24-5219

Specifies local PSF printer destinations.

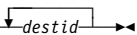
▶▶ DEST ▶▶

DUMP

One

VM/RSCS: Planning and Installation, SH24-5219

Tells RSCS what type of dump to take when an RSCS error (abend) occurs and the user (virtual machine) to which RSCS should send the dump.

▶▶ DUMP (1) ▶▶

Note:

¹ If **DUMP** statement omitted, a VM-type dump will be produced.

EXIT

EXIT

No Limit

VM/RSCS: Planning and Installation, SH24-5219

Defines and loads RSCS exit routine modules during RSCS initialization.

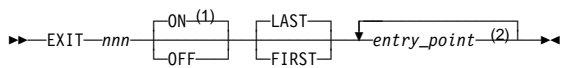

Notes:

- 1 Must be specified if the first (or only) *entry_point* name is "ON".
- 2 The number of *entry_points* allowed is limited to the number of names that will fit on one EXIT statement.

FCB

No Limit

VM/RSCS: Planning and Installation, SH24-5219

Defines an FCB image which RSCS will simulate on SNA3270P- and 3270P-type links.

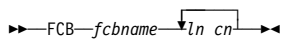

FORM

No Limit

VM/RSCS: Planning and Installation, SH24-5219

Specifies the characteristics of a form name.

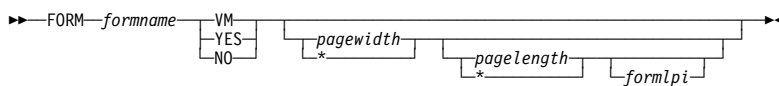

HIDECHARACTER

HIDECHARACTER

One

VM/RSCS: Planning and Installation, SH24-5219

Specifies a default hide character to be used to mark sections of the link parameter definitions in the RSCS configuration file or the RSCS events file that you do not want displayed in response to a QUERY command.

▶▶—HIDEcharacter—c—▶▶

IMBED

No Limit

VM/RSCS: Planning and Installation, SH24-5219

Includes another file into the RSCS configuration file or the events file.

▶▶—IMBED—

<i>ddname</i>
<i>fn ft</i>

—▶▶

ITRACE

ITRACE

No Limit

VM/RSCS: Planning and Installation, SH24-5219

Defines the initial state of the RSCS internal trace table, defines the events RSCS will trace, and optionally starts tracing when RSCS initializes.

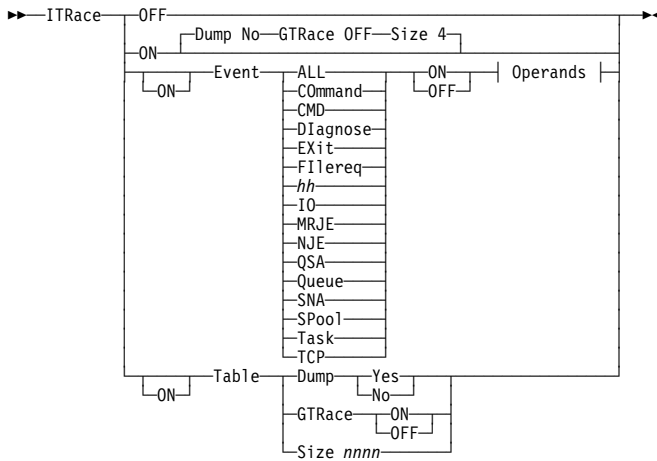

Operands:

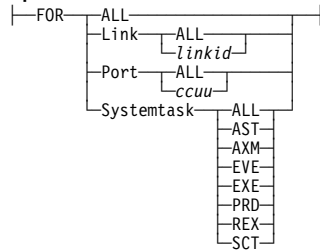

LANGUAGE

One

VM/RSCS: Planning and Installation, SH24-5219

Specifies the name of a load module containing a compiled RSCS message file.

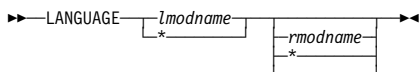

LINK

LINK

No Limit

VM/RSCS: Planning and Installation, SH24-5219

Defines the default attributes of an RSCS link.

```
LINK linkid [(1) type ccuu * class * queue dp luname logmode autostart retry]
```

Note:

- Operands are positional. All unspecified operands, before the one that has been specified, **must** have their position indicated with an asterisk (*).

LINKDEFine

No Limit

VM/RSCS: Planning and Installation, SH24-5219

Defines the default attributes of an RSCS link.

```
LINKDEFine linkid [NOASTart] [AST] [Class *] [Class c] [DP 5] [DP dpriority] [FANout linkid] [FCB IGNORE] [FCB DYNAMIC fcbname]
[LINE 0000] [LINE ccuu] [LOGMode logmodename] [LUName luname] [NODE nodeid] [Queue Priority] [Queue Fifo Size] [NORETry] [RETry]
[MANual] [AUto] [SEtup] [F0rm name] [SLOWdown] [start_point stop_point] [TRace ALL] [TRace LOG] [TRace OFF] [TRace RECOords]
TYPE ASCII
GATEWAY
LISTPROC
LPD
LPR
MRJE
NJE
NOTIFY
RJE
SNANJE
SNARJE
SNA3270P
TCPASCII
TCPNJE
TN3270E
UFT
UFTD
3270P
```



LINKTYPE

LINKTYPE

No Limit

VM/RSCS: Planning and Installation, SH24-5219

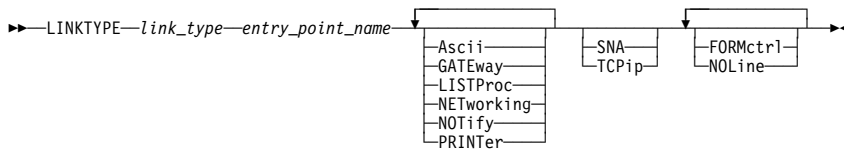
Dynamically defines additional line drivers to the base RSCS system.



LOCAL

One

VM/RSCS: Planning and Installation, SH24-5219

Defines the name by which the local RSCS node is known to other nodes in the network.

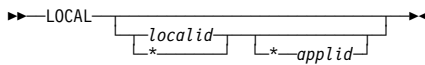

MSGNOH

One

VM/RSCS: Planning and Installation, SH24-5219

Tells RSCS to use the CP MSGNOH command when issuing messages to local users.



OPFORM

OPFORM

One

VM/RSCS: *Planning and Installation*, SH24-5219

Specifies the default operator form name for printer forms control for print files, and is analogous to the DEFprt keyword of the VM SYSFORM macro.

▶▶ OPFORM *formname* ▶▶

Note:

1 If OPFORM statement omitted, STANDARD is used as the default form name.

OPTION

No Limit

VM/RSCS: *Planning and Installation*, SH24-5219

Defines defaults for various RSCS system-oriented and link-oriented parameters.

▶▶ OPTION *ACmsg=No* *ENQmsg=No* *FINa1msg=Yes* *JOBName=Rscs* *LISTproc=No* *ACmsg=Yes* *ENQmsg=Yes* *FINa1msg=No* *JOBName=Userid* *LISTproc=Yes* ▶▶

▶▶ *LOOPing=ALL* *MAXDsh=10* *MAXHops=64* *MSGSKip=2* *QMSGlim=0* *SECOrgid=Yes* *LOOPing=HOPs* *MAXDsh=nnn* *MAXHops=nnn* *MSGSKip=nn* *QMSGlim=nnnnn* *SECOrgid=No* *LOOPing=IMMEDiate* *LOOPing=NONE* ▶▶

▶▶ *SEntmsg=No* *VAFP=Yes* *5DIGit=No* *SEntmsg=Yes* *VAFP=No* *5DIGit=Yes* ▶▶

PARM for ASCII-Type Link

VM/RSCS: *Planning and Installation*, SH24-5219

PARM for ASCII-Type Link

▶▶ PARM *linkid* (1) *EXIT=name* *ATTN=Yes* *ATTN=No* *EParam='value'* *ITO=100* *ITO=nnn* *MSG=Yes* *MSG=No* ▶▶

Note:

1 If EXIT keyword is omitted or if the exit module cannot be found, the line driver will not start.

PARM for ASCII-Type Link

PARM for GATEWAY-Type Link

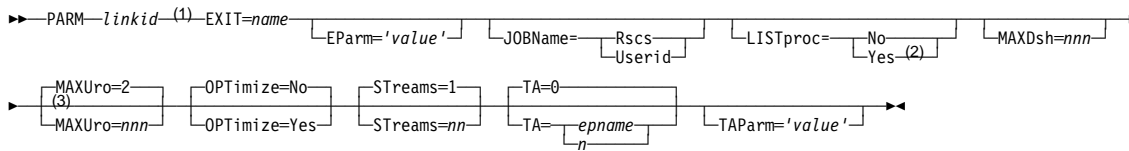

Notes:

- 1 If the EXIT keyword is omitted or if RSCS cannot find the exit module, the line driver will not start.
- 2 The MAXD keyword is ignored if LIST=Yes is specified.
- 3 The MAXU keyword is ignored if a LISTPROC link is not defined.

PARM for LISTPROC-Type Link

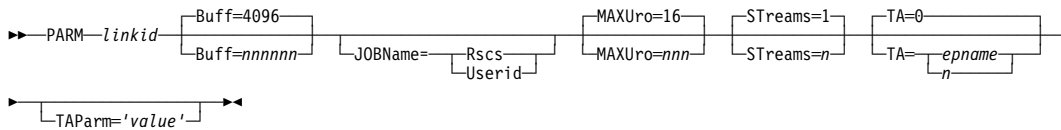

PARM for LPD-Type Link

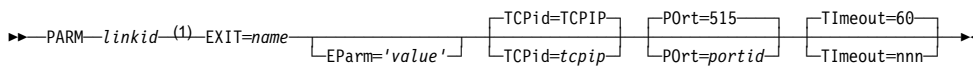

Note:

- 1 If EXIT keyword is omitted or if the exit module cannot be found, the line driver will not start.

PARM for ASCII-Type Link

PARM for LPR-Type Link

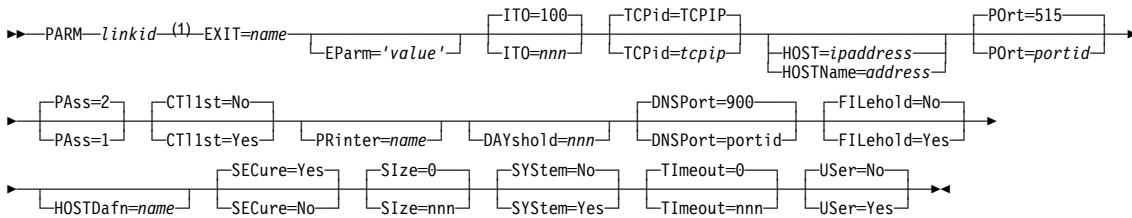

Note:

- 1 If the EXIT keyword is omitted or if the exit module cannot be found, the line driver will not start.

PARM for MRJE-Type Link

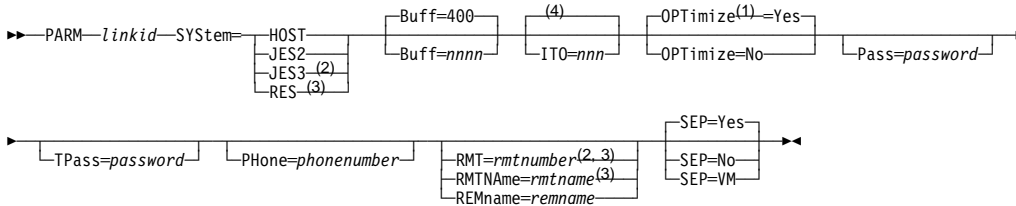

Notes:

- 1 OPTimize is valid only if SYSTEM=HOST is also specified; otherwise, OPTimize is meaningless and will be ignored.
- 2 If SYSTEM=JES3 is specified, then either RMT or RMTNAME must be specified.
- 3 If SYSTEM=RES is specified, then RMT must be specified.
- 4 The default value for ITO is 1 minute for a dialed link and 100 (active until deactivated manually or a nonrecoverable error occurs) for a link that is not dialed.

PARM for ASCII-Type Link

PARM for NJE-Type Link

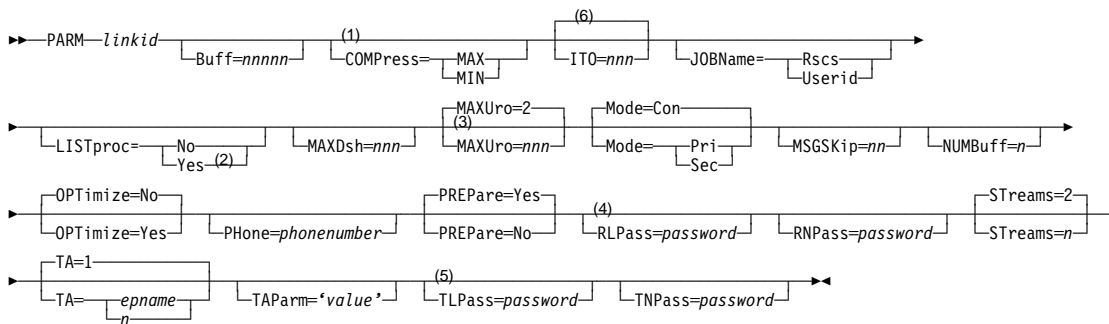

Notes:

- 1 If COMP omitted, default is MIN for CTCA links and MAX for BSC and SNA links.
- 2 MAXD keyword ignored if LIST=YES is specified.
- 3 MAXU keyword ignored if a LISTPROC link is not defined.
- 4 For an auto-answer link, RLPASS, RNPASS, or both must be specified.
- 5 To connect to a remote system where RLPASS is specified, TLPASS must be specified.
To connect to a remote system where RNPASS is specified, TNPASS must be specified.
- 6 The default value for ITO is 1 minute for a dialed link and 100 (active until deactivated manually or a nonrecoverable error occurs) for a link that is not dialed.

PARM for NOTIFY-Type Link

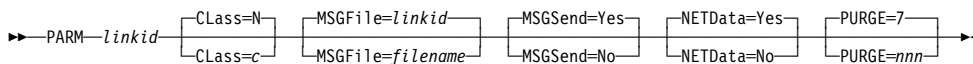

PARM for ASCII-Type Link

PARM for RJE-Type Link

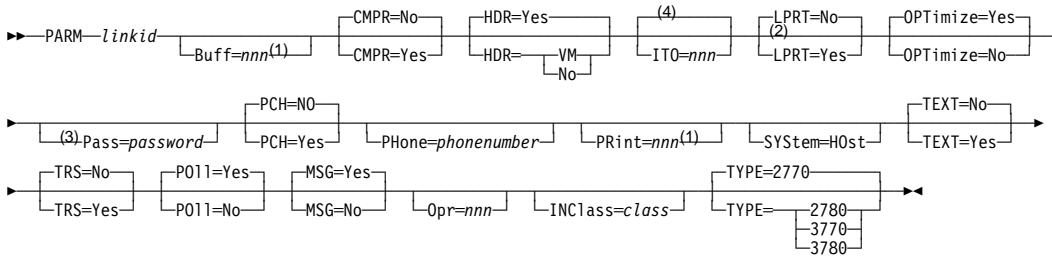

Notes:

- 1 To avoid print-line truncation on a 2770, the buffer size (Buff=nnn) must be larger than the print position size (PRint=nnn).
- 2 LPRT is valid only when TYPE=3770.
- 3 For an auto-answer link, PASS is mandatory.
- 4 The default value for ITO is 1 minute for a dialed link and 100 (active until deactivated manually or a nonrecoverable error occurs) for a link that is not dialed.

PARM for SNANJE-Type Link

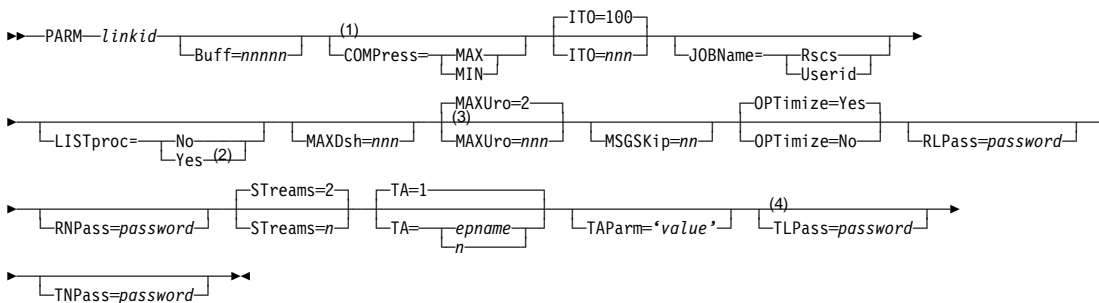

Notes:

- 1 If COMP omitted, default is MIN for CTCA links and MAX for BSC and SNA links.
- 2 MAXD keyword ignored if LIST=YES is specified.
- 3 MAXU keyword ignored if a LISTPROC link is not defined.
- 4 To connect to a remote system where RLPASS is specified, TLPASS must be specified.
To connect to a remote system where RNPASS is specified, TNPASS must be specified.

PARM for ASCII-Type Link

PARM for SNARJE-Type Link

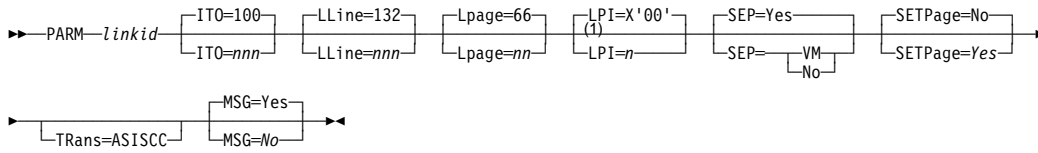

Note:

- 1 LPI specifies the number of lines per inch you want printed on the form for an LU_T1 session.

PARM for SNA3270P-Type Link

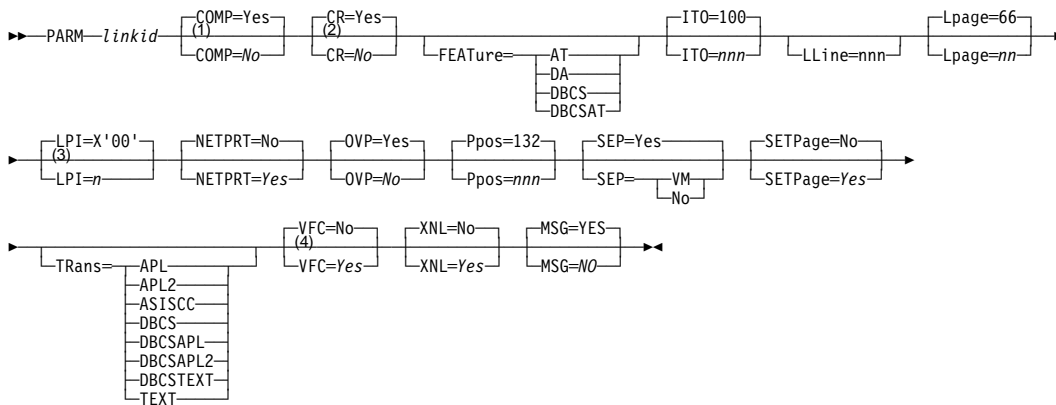

Notes:

- 1 This keyword ignored if specified for a printer defined for LU_T1 sessions.
- 2 CR has no meaning unless VFC=YES is also specified.
- 3 LPI specifies the number of lines per inch you want printed on the form for an LU_T1 session.
- 4 Generally it is recommended to specify VFC=YES.

PARM for ASCII-Type Link

PARM for TCPASCII-Type Link

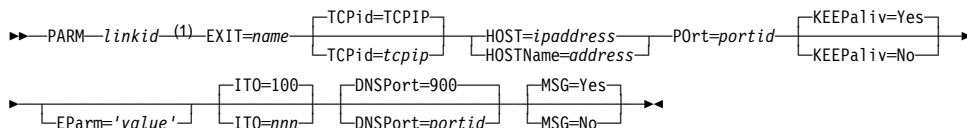

Note:

1 If EXIT keyword is omitted or if the exit module cannot be found, the line driver will not start.

PARM for TCPNJE-Type Link

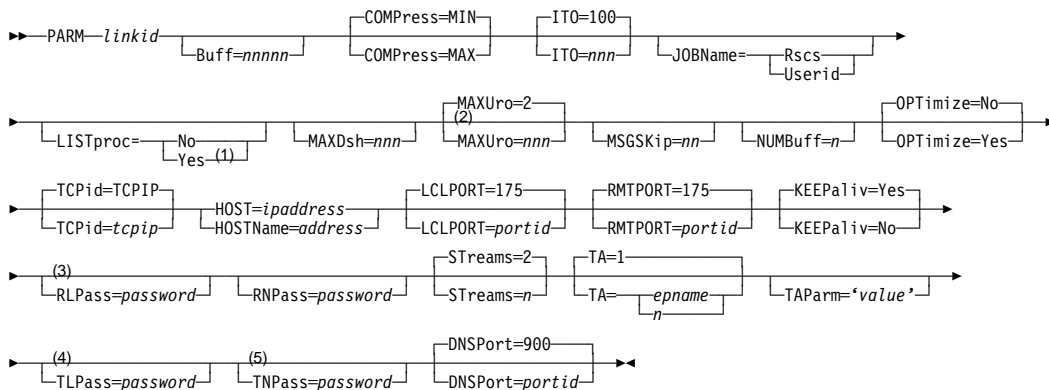

Notes:

- 1 MAXD keyword ignored if LIST=YES is specified.
- 2 MAXU keyword ignored if a LISTPROC link is not defined.
- 3 For an auto-answer link, RLPASS, RNPASS, or both must be specified.
- 4 To connect to a remote system where RLPASS is specified, TLPASS must be specified.
- 5 To connect to a remote system where RNPASS is specified, TNPASS must be specified.

PARM Statements

PARM for 3270P-Type Link

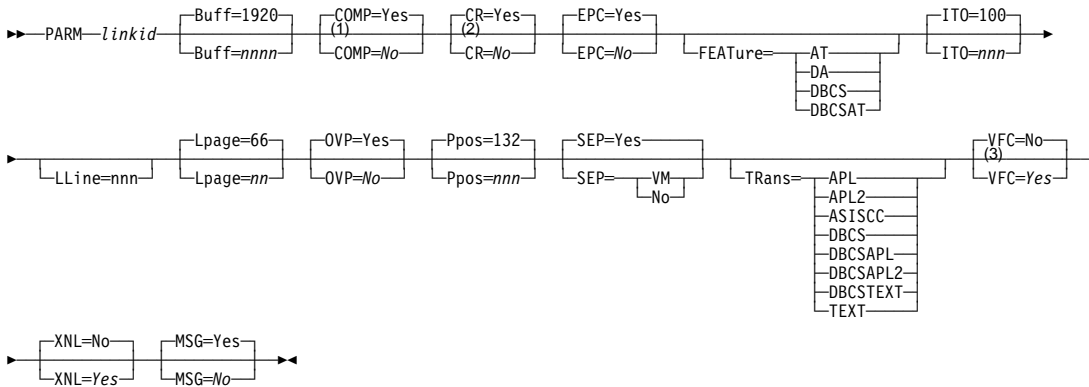

Notes:

- 1 Specify NO for locally attached printers.
- 2 CR has no meaning unless VFC=YES is also specified.
- 3 Generally it is recommended to specify VFC=YES.

PARM Statements

No Limit

VM/RSCS: Planning and Installation, SH24-5219

The PARM statement defines operational characteristics to be used by the link driver handling the specified link. The PARM information is made available to the driver when the link is started.

The format and content of PARM information is different for each type of link.

Include as many statements as needed; they are optional. However, you can only have one PARM statement for each link ID. PARM statements may be placed anywhere in the configuration file after the LINK or LINKDEFINE statements to which they refer.

Specifies a virtual device number for a BSC line to be used by an auto-dial or auto-answer link, or for dynamic allocation of a BSC link.

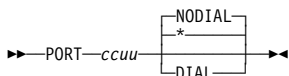

RECOVERY

RECOVERY

One

VM/RSCS: Planning and Installation, SH24-5219

Specifies which CP command (or commands) should be issued when an RSCS task abends causing RSCS to become disabled.

```
►► RECOVERY ──┬─ # ──┬─ cp_command ──┬─ (1) ──►
```

Note:

¹ The pound sign (#) specifies the CP logical end of line character.

RERoute

No Limit

VM/RSCS: Planning and Installation, SH24-5219

Modifies the original destination of commands, files, and messages for specific systems and user IDs.

```
►► RERoute ──┬─ ALL ──┬─ FOR ──┬─ nodeid ──┬─ userid ──┬─ TO ──┬─ nodeid ──┬─ userid ──►
              │ Files │         │ ANY   │ ANY   │         │ *     │ SYSTEM │
              │ Msgs  │         │ *     │ *     │         │     │     │
              └─ NOTrcvg ──┬─ FOR ──┬─ userid ──┬─ ANY ──┬─ TO ──┬─ nodeid ──┬─ nodeid ──►
                           │         │ ANY   │ *     │ *     │         │ *     │
                           └─ Cnds ──┬─ FOR ──┬─ nodeid ──┬─ TO ──┬─ nodeid ──┬─ nodeid ──►
                                   │         │ ANY   │ *     │ *     │         │ *     │
                                   └─ Quiet ──┬─ FOR ──┬─ nodeid ──┬─ TO ──┬─ nodeid ──┬─ nodeid ──►
                                              │         │ ANY   │ *     │ *     │         │ *     │
```

RETRY

One

VM/RSCS: Planning and Installation, SH24-5219

Tells RSCS when to restart deactivated auto-dial and SNA links.

```
►► RETRY ──┬─ nnnn ──┬─ (1) ──►
```

Note:

¹ Up to 50 intervals can be specified.

ROUTE

ROUTE

No Limit

VM/RSCS: Planning and Installation, SH24-5219

Defines a path to a non-adjacent node.

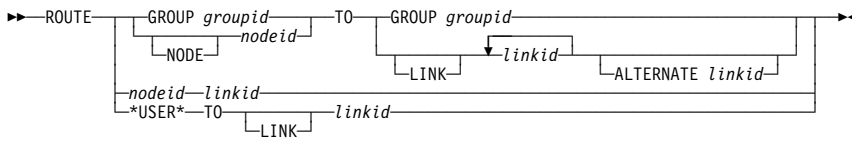

SAFCLASS

One

VM/RSCS: Planning and Installation, SH24-5219

Specifies the output class to be used when RSCS creates store-and-forward files.

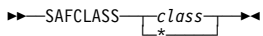

SETMSG

No Limit

VM/RSCS: Planning and Installation, SH24-5219

Starts the sharing of nonprivate RSCS messages based on the message number.

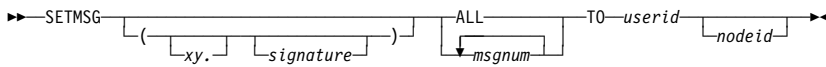

SHADOWS

SHADOWS

One

VM/RSCS: Planning and Installation, SH24-5219

Specifies how many tag shadow elements RSCS should reserve.

►► SHADOWS $\left[\begin{array}{l} \text{20000} \\ \text{nnnnn (1)} \end{array} \right]$ ◄◄

Note:

¹ *nnnnn* is a decimal number in the range 20000 to 100000.

SLOWDOWN

One

VM/RSCS: Planning and Installation, SH24-5219

Tells RSCS when to automatically start or stop slowdown mode.

►► SLOWdown $\text{nnnnn} \left[\begin{array}{l} * \\ \text{nnnn} \end{array} \right]$ ◄◄

TOLERANCE

No Limit

VM/RSCS: Planning and Installation, SH24-5219

Marks areas of the configuration file as tolerant or intolerant of errors.

►► TOLerance $\left[\begin{array}{l} \text{ON} \\ \text{OFF} \end{array} \right]$ ◄◄

TRACEDEST

One

VM/RSCS: Planning and Installation, SH24-5219

Tells RSCS where to send trace files.

►► TRACEdest $\text{userid} \left[\begin{array}{l} \text{nodeid} \end{array} \right]$ ◄◄

UPARM

UPARM

No Limit

VM/RSCS: Planning and Installation, **SH24-5219**

Specifies additional, installation-defined parameters.

▶—UPARM—*linkid*—*user_parameters*—▶

Terminal SIGNON Cards

Terminal SIGNON Cards

Each RJE workstation attached to an RSCS node must send a SIGNON card to that node after the RSCS START command has initialized that terminal's RJE link. The SIGNON card has the following format:

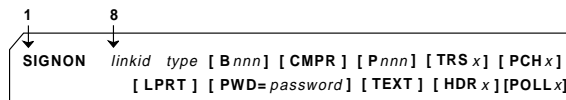

Each MRJE workstation attached to an RSCS MRJE line driver in HOST mode, must send a SIGNON card in the following format. Note that the *tpassword* may start in either column 35 or 73.

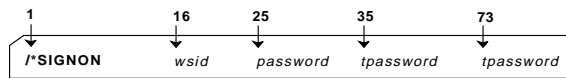

Workstations transmitting to RSCS (MRJE-, RJE-, and SNARJE-type links) must submit an ID card as the first card of each card deck. The ID card identifies the user to the attached VM/ESA system:

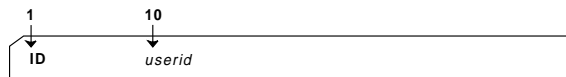

The following ID card identifies a user on a remote system to the attached VM/ESA system; (the *userid* may be replaced by the keyword SYSTEM or JOB):

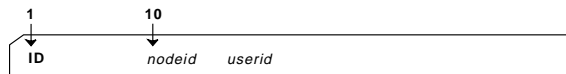

Terminal SIGNON Cards

Diagnostic Subcommands

RSCS provides the following subcommands to be used with the DUMPSCAN command of the Dump Viewing Facility component of VM/ESA.

CVT

VM/RSCS: Diagnosis Reference, SC24-5881

The CVT subcommand displays the contents of the communications vector table.

▶▶—CVT—◀◀

DWA

VM/RSCS: Diagnosis Reference, SC24-5881

The DWA subcommand formats and displays the dynamic work area (DWA) for any RSCS link.

▶▶—DWA *linkid*—◀◀

IOTABLE

VM/RSCS: Diagnosis Reference, SC24-5881

The IOTABLE subcommand formats and displays a link's RSCS I/O table (IOTABLE) chain for a specified record control byte (RCB).

▶▶—IOTABLE *linkid rcb*—◀◀

ITRACE

ITRACE

VM/RSCS: *Diagnosis Reference*, **SC24-5881**

The ITRACE subcommand formats and displays the RSCS internal wrap-around trace table.

```
▶▶ ITRACE [FOR ALL] [FROM START] [LAST nnnnnn] [FORMAT nnnn] [TASKID taskid] [LINKID linkid] ▶▶  
[FOR nnnnnn] [FROM nnnnnn]
```

LINKS

VM/RSCS: *Diagnosis Reference*, **SC24-5881**

The LINKS subcommand displays the RSCS link queue.

```
▶▶ Links [ALL] [linkid] ▶▶
```

NDWA

VM/RSCS: *Diagnosis Reference*, **SC24-5881**

NDWA formats and displays the network dynamic work area (NDWA) for a specific networking link.

```
▶▶ NDWA linkid ▶▶
```

RIB

VM/RSCS: *Diagnosis Reference*, **SC24-5881**

The RIB subcommand displays the contents of receiving information blocks (RIBs).

```
▶▶ RIB linkid [rcb] ▶▶
```

ROUTES

ROUTES

VM/RSCS: Diagnosis Reference, SC24-5881

The ROUTES subcommand displays the contents of the RSCS routing table.

▶▶—ROutes—◀◀

TAGQUE

VM/RSCS: Diagnosis Reference, SC24-5881

The TAGQUE subcommand displays tag queue information for a specified link. The information is displayed in dump format.

▶▶—TAGque *linkid*

ALL
Input
Output

—◀◀

TIB

VM/RSCS: Diagnosis Reference, SC24-5881

The TIB subcommand displays the contents of transmitting information blocks.

▶▶—TIB *linkid*

<i>rcb</i>

—◀◀

TIB

ADDINFORM

RSCS Interchange Commands

This section lists the RSCS Interchange commands, which can be issued from the RSCS Interchange console. Authorized VM/ESA users who are on the same system as the RSCS Interchange server can also issue these commands using the CP SMSG command.

ADDINFORM

User: P

RSCS Data Interchange Manager Installing, Managing, and Using, SH24-5248

Temporarily enables users to receive ADMIN messages from RSCS Interchange.

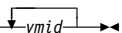
▶▶—ADDInform——◀◀

ADDPRIV

User: P

RSCS Data Interchange Manager Installing, Managing, and Using, SH24-5248

Temporarily enables users to enter privileged commands on the RSCS Interchange server.

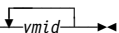
▶▶—ADDPriv——◀◀

CMS

User: P

RSCS Data Interchange Manager Installing, Managing, and Using, SH24-5248

Enables the RSCS Interchange to issue CMS commands.

▶▶—CMS—command—◀◀

CP

CP

User: P

RSCS Data Interchange Manager Installing, Managing, and Using, SH24-5248

Enables the RSCS Interchange to issue CP commands.

▶▶—CP—command—◀◀

DEBUG

User: P

RSCS Data Interchange Manager Installing, Managing, and Using, SH24-5248

Traces various areas of RSCS Interchange; output may be sent to the console or to a file.

▶▶—DEBUG—| Area Name |

OFF
tracetype
TO—userid

—◀◀

Area Name:

ALL
Command
Files
SMTNote
CMSNote

DELINFORM

User: P

RSCS Data Interchange Manager Installing, Managing, and Using, SH24-5248

Temporarily prevents users from receiving ADMIN messages from RSCS Interchange.

▶▶—DELInform—

vmid

—◀◀

DELPRIV

User: P

RSCS Data Interchange Manager Installing, Managing, and Using, SH24-5248

Temporarily prevents users from issuing privileged RSCS Interchange commands.

▶▶—DELPriv—

vmid

—◀◀

LISTINFORM

LISTINFORM

User: P

RSCS Data Interchange Manager Installing, Managing, and Using, SH24-5248

Displays users who may receive ADMIN messages from the RSCS Interchange server.

▶▶—LISTInform—◀◀

LISTPRIV

User: P

RSCS Data Interchange Manager Installing, Managing, and Using, SH24-5248

Displays users who are authorized to issued privileged RSCS Interchange commands.

▶▶—LISTPriv—◀◀

NICK

User: G,P

RSCS Data Interchange Manager Installing, Managing, and Using, SH24-5248

Adds, deletes, or changes a nickname entry.

▶▶—NICK—
┌—Add—
├—Change—
└—Delete—
 nickname—SMTP_address
 nickname

QNICK

User: P

RSCS Data Interchange Manager Installing, Managing, and Using, SH24-5248

Allows users to quickly enter many NICK commands to update the nickname table.

▶▶—QNICK—
┌—OFF—
└—ON—

QUERY

QUERY

User: G

RSCS Data Interchange Manager Installing, Managing, and Using, SH24-5248

Displays general status about the RSCS Interchange server.

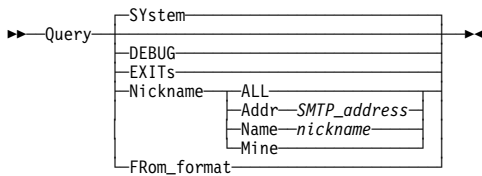

RESTRICT

User: P

RSCS Data Interchange Manager Installing, Managing, and Using, SH24-5248

Maintains a list of users who are not permitted to use the gateway.

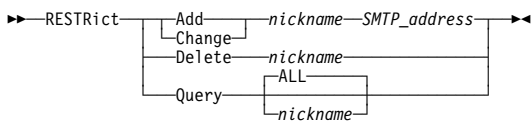

STOP

User: P

RSCS Data Interchange Manager Installing, Managing, and Using, SH24-5248

Stops the RSCS Interchange server.

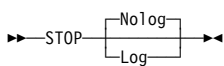

RSCS Interchange Configuration File Statements

The RSCS Interchange configuration file statements are specified in the ACHARSCS CONFIG file. The DOMAIN and RSCSLINK statements are required; other statements are optional.

ADMIN

One

RSCS Data Interchange Manager Installing, Managing, and Using, SH24-5248

Specifies the user ID of the RSCS Interchange server administrator.

```

▶▶—ADMIN—┌──MAINT──┐▶▶
           └──vmid──┘
  
```

AUTHORIZE

No limit

RSCS Data Interchange Manager Installing, Managing, and Using, SH24-5248

Identifies users who are authorized to issue privileged commands.

```

▶▶—AUTHORIZE—vmid—▶▶
  
```

DOMAIN

One

RSCS Data Interchange Manager Installing, Managing, and Using, SH24-5248

Specifies the IP domain name of the RSCS Interchange server in the TCP/IP network.

```

▶▶—DOMAIN—domain_name—▶▶
  
```

EXIT

EXIT

No Limit

RSCS Data Interchange Manager Installing, Managing, and Using, SH24-5248

Identifies all user-installed exit routines.

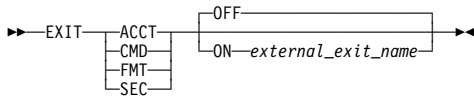

FROM_FORMAT

One

RSCS Data Interchange Manager Installing, Managing, and Using, SH24-5248

Specifies the format of the From: header of files that are sent to SMTP and are destined for a remote domain.

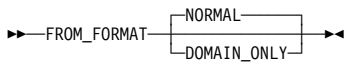

INFORM_USER

No Limit

RSCS Data Interchange Manager Installing, Managing, and Using, SH24-5248

Specifies user IDs to be notified when RSCS Interchange sends message to the ADMIN user ID.

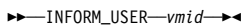

LOG_DISK

One

RSCS Data Interchange Manager Installing, Managing, and Using, SH24-5248

Specifies the file mode of the RSCS Interchange log files.

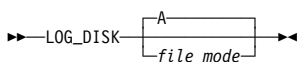

LOG_KEEP

LOG_KEEP One

RSCS Data Interchange Manager Installing, Managing, and Using, SH24-5248

Specifies how long RSCS Interchange will retain log files.

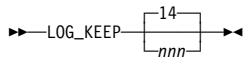

MSGNOH One

RSCS Data Interchange Manager Installing, Managing, and Using, SH24-5248

Enables the RSCS Interchange server to use the CP MSGNOH command when issuing messages.



NICK_OVERRIDE One

RSCS Data Interchange Manager Installing, Managing, and Using, SH24-5248

Determines how nicknames can be specified in notes and if a nickname can be overridden with explicit addressing within the note.

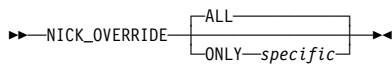

NICKPRIV One

RSCS Data Interchange Manager Installing, Managing, and Using, SH24-5248

Specifies if general users can use the NICK command to modify the nickname table.

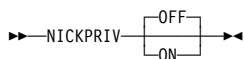

NICKTABLE

NICKTABLE

One

RSCS Data Interchange Manager Installing, Managing, and Using, SH24-5248

Identifies the name of the nickname file RSCS Interchange uses to translate SMTP addresses.

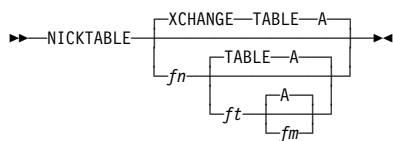

RCSLINK

One

RSCS Data Interchange Manager Installing, Managing, and Using, SH24-5248

Specifies the link ID that is defined to the RSCS virtual machine for the RSCS Interchange link.

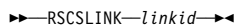

RSCSNAME

One

RSCS Data Interchange Manager Installing, Managing, and Using, SH24-5248

Identifies the user ID of the RSCS virtual machine to which RSCS Interchange sends and receives VM/ESA network mail.

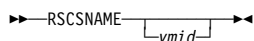

SMTPNAME

One

RSCS Data Interchange Manager Installing, Managing, and Using, SH24-5248

Specifies the name of the Simple Mail Transfer Protocol (SMTP) server that will handle mail destined to SMTP users.

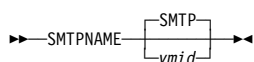

TEMP_KEEP

TEMP_KEEP

One

RSCS Data Interchange Manager Installing, Managing, and Using, **SH24-5248**

Specifies how long temporary nickname entries will be retained.

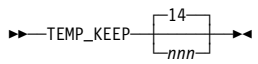

TEMP_KEEP

Other Commands Used with RSCS

This section describes the CMS and CP commands that are commonly used with RSCS or RSCS Interchange.

HELP

User: G,R,L,S,C

VM/RSCS: Operation and Use, SH24-5220

Displays the online HELP files for RSCS and RSCS Interchange commands and messages.

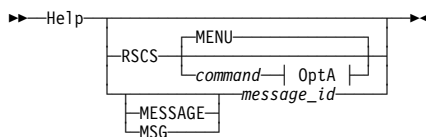

OptA:

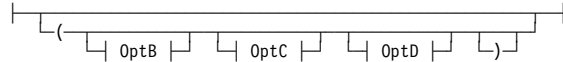

OptB:

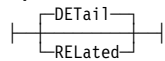

OptC:



OptD:

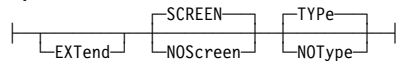

To display HELP information about a specific area, enter one of the following commands:

HELP Command	Information Displayed	Example
help rscs <i>command</i>	RSCS command	help rscs start
help rque <i>command</i>	RSCS QUERY command	help rque system
help rdvf <i>subcommand</i>	RSCS subcommand used with the Dump Viewing Facility	help rdvf cvt
help inch <i>subcommand</i>	RSCS Interchange command	help inch quick
help msg <i>message-id</i>	Specific RSCS or RSCS Interchange message	help msg dmt101i
help prod menu	Menu of RSCS or RSCS Interchange commands	help inch menu

PPS EXEC

PPS EXEC

User: G,R,L,S,C

VM/RSCS: Operation and Use, SH24-5220

The PPS EXEC command can be used from the CMS ready prompt to send files, including Postscript files.

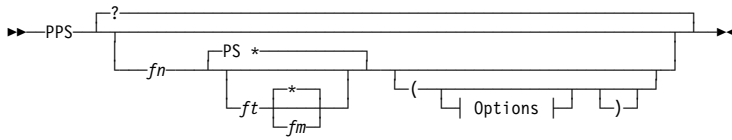

Options:

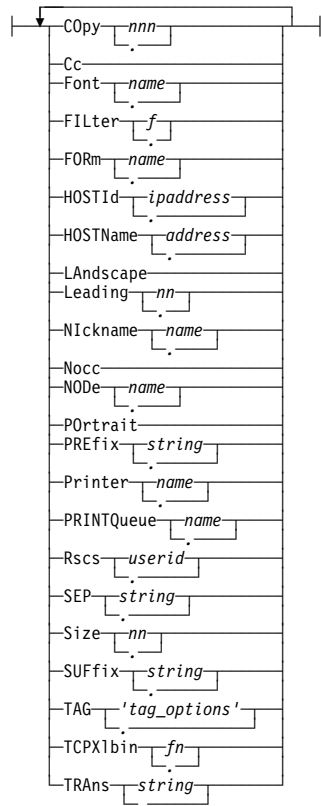

PPS XEDIT

PPS XEDIT

User: G,R,L,S,C

VM/RSCS: *Operation and Use*, SH24-5220

The PPS XEDIT macro can be used from within the XEDIT environment to send files, including Postscript files.

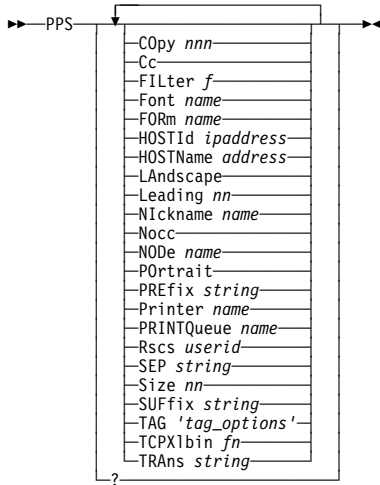

SMSG

User: G,R,L,S,C

VM/RSCS: *Operation and Use*, SH24-5220

Sends command text to RSCS for execution.

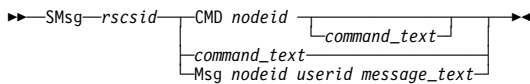

SPOOL

SPOOL

User: G,R,L,S,C

VM/RSCS: Operation and Use, SH24-5220

Changes spooling control options.

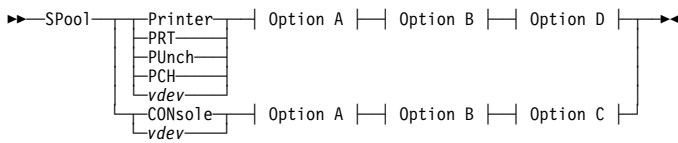

Option A:

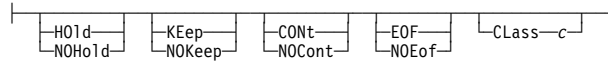

Option B:

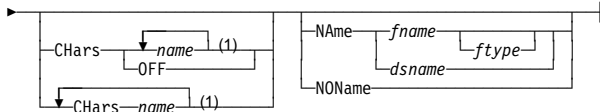
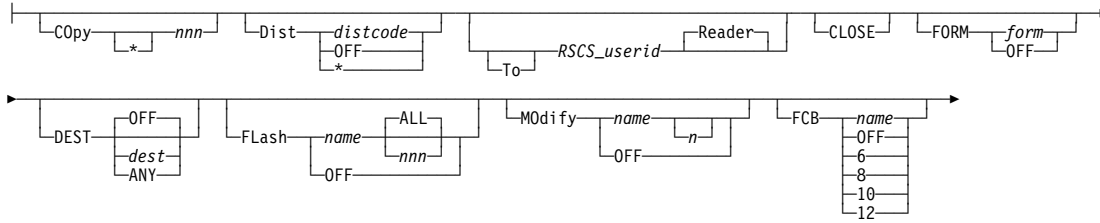

Option C:

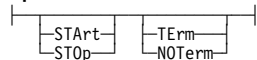

Option D:

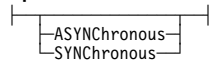

Notes:

- 1 A maximum of four names can be specified.
- 2 You must specify at least one of the specified options.

TAG

TAG

User: G,R,L,S,C

VM/RSCS: Operation and Use, SH24-5220

Specifies the destination of and additional control information for a spool file.

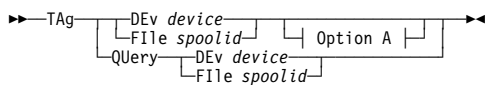

Option A:

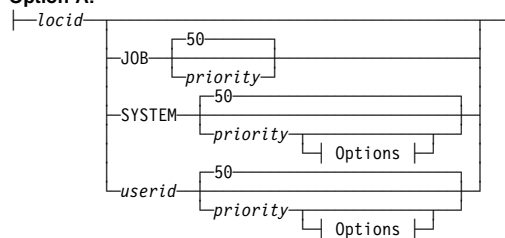

The options for the CP TAG command are:

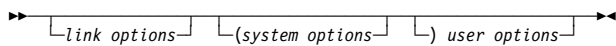

Sending a file to an IBM 3270 Information Display System Printer:

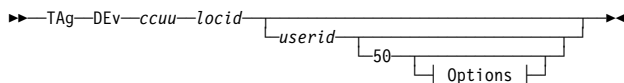

3270 Link Options:

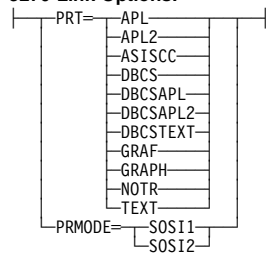

Sending Print Output to a SNARJE Workstation:

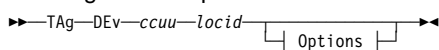

Options:

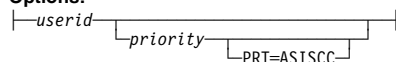

TAG

Sending Punch Output to a NJE System:

►TAG=DEV=ccuu=locid [Options]

Options:

[userid] [priority] [PUNCC=NO/YES]

Sending Print Output to an NJE System:

►TAG=DEV=ccuu=locid [Options]

Options:

[userid] [priority] [options]

NJE Link Options:

[BLDG=building(1)] [DEPT=department(1)] [EXTWTR=writername(1)] [FCB=buffername]

[FORMS=formsname] [HOLD=NO/YES] [INDEX=offset(1)] [JOBNAME=jobname(1)] [RSCS] [USERID]

[PGRNAME=programname(1)] [PRMODE=LINE/PAGE/SOSI1/SOSI2] [ROOM=room(1)] [SYSOUT=outclass(1)]

[UCS=charset(1)]

Note:

¹ This option has meaning in a non-VM system only.

If the receiving subsystem will print data on an IBM 3800 printer, the following options can be specified:

3800 Link Options:

[BURST=Y/N(1)] [CHARS=(2)tablename] [COPYG=(2)nnn] [FLASH=overlay]

[FLASHC=modify] [MODIFY=modify] [MODTRC=n] [OPTCD=J]

Notes:

¹ This option has meaning in a non-VM/ESA system only.

² This can be repeated; see operand notes for details.

TAG System Options

System Options:

([ACcmsg=No] [ENQmsg=No] [FINa1msg=Yes] [SEntmsg=No])

([ACcmsg=Yes] [ENQmsg=Yes] [FINa1msg=No] [SEntmsg=Yes])

Bibliography

This bibliography lists the books that provide additional information about your system.

RSCS Library

The following table lists the books in the RSCS library and their order numbers by task-oriented category.

Title	Order Number
Evaluation	
VM/RSCS: Licensed Program Specifications	GH24-5223
VM/RSCS: General Information	GH24-5218
Planning, Installation, and Service	
VM/RSCS: Planning and Installation	SH24-5219
VM/RSCS: Data Interchange Manager Installing, Managing, and Using	SH24-5248
End Use	
VM/RSCS: Operation and Use	SH24-5220
VM/RSCS: Reference Summary	SX24-5257
Customization	
VM/RSCS: Exit Customization	SH24-5222
Diagnosis and Reference	
VM/RSCS: Diagnosis Reference	SC24-5881
VM/RSCS: Messages and Codes	SH24-5221

Readers' Comments
SX24-5257-03



Cut or Fold
Along Line

Fold and Tape

Please do not staple

Fold and Tape



NO POSTAGE
NECESSARY
IF MAILED IN THE
UNITED STATES

BUSINESS REPLY MAIL

FIRST-CLASS MAIL PERMIT NO. 40 ARMONK, NEW YORK

POSTAGE WILL BE PAID BY ADDRESSEE

Department G60
International Business Machines Corporation
Information Development
1701 North Street
ENDICOTT NY 13760-5553

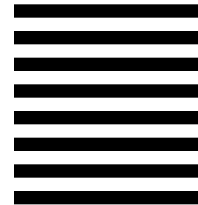

Fold and Tape

Please do not staple

Fold and Tape

SX24-5257-03

Cut or Fold
Along Line



File Number: S370/4300-39
Program Number: 5684-096



Printed in the United States of America
on recycled paper containing 10%
recovered post-consumer fiber.

SX24-5257-03

