

AS/400 Advanced Series



IDDU Use

Version 4

AS/400 Advanced Series



IDDU Use

Version 4

Take Note!

Before using this information and the product it supports, be sure to read the general information under "Notices" on page ix.

First Edition (August 1997)

This edition applies to the licensed program IBM Operating System/400 (Program 5769-SS1), Version 4 Release 1 Modification 0, and to all subsequent releases and modifications until otherwise indicated in new editions.

Make sure that you are using the proper edition for the level of the product.

Order publications through your IBM representative or the IBM branch serving your locality. If you live in the United States, Puerto Rico, or Guam, you can order publications through the IBM Software Manufacturing Solutions at 800+879-2755. Publications are not stocked at the address given below.

IBM welcomes your comments. A form for readers' comments may be provided at the back of this publication. You can also mail your comments to the following address:

IBM Corporation
Attention Department 542
IDCLERK
3605 Highway 52 N
Rochester, MN 55901-7829 USA

or you can fax your comments to:

United States and Canada: 800+937-3430
Other countries: (+1)+507+253-5192

If you have access to Internet, you can send your comments electronically to IDCLERK@RCHVMW2.VNET.IBM.COM; IBMMAIL, to [IBMMAIL\(USIB56RZ\)](mailto:IBMMAIL(USIB56RZ)).

When you send information to IBM, you grant IBM a nonexclusive right to use or distribute the information in any way it believes appropriate without incurring any obligation to you.

© **Copyright International Business Machines Corporation 1997. All rights reserved.**

Note to U.S. Government Users — Documentation related to restricted rights — Use, duplication or disclosure is subject to restrictions set forth in GSA ADP Schedule Contract with IBM Corp.

Contents

Notices	ix
Trademarks and Service Marks	ix
About IDDU Use (SC41-5704)	xi
Who Should Use This Book	xi
Prerequisite and Related Information	xi
Information Available on the World Wide Web	xi

Part 1. Introduction to Data Definition

Chapter 1. File Concepts	1-1
Fields	1-2
Records	1-2
Files	1-2
File Storage	1-2
File Processing	1-3
Using Data in Documents	1-4
Querying Data	1-4
Maintaining Data	1-5
Describing Data	1-6
Chapter 2. Data Definition Concepts	2-1
Database Files	2-1
Data Dictionaries	2-2
Data Definitions	2-2
Field Definitions	2-3
Record Format Definitions	2-3
File Definitions	2-3
How Do All These Definitions Fit Together?	2-4
Interactive Data Definition Utility (IDDU)	2-4
IDDU Features	2-5
IDDU Capabilities	2-7
Using Data in Queries and Documents	2-7
Chapter 3. Getting Started	3-1
Getting to IDDU	3-1
Interactive Data Definition Utility (IDDU) Menu	3-1
Work with ... Displays	3-2
IDDU Displays to Create or Change Objects	3-4
Creating Data Definitions	3-6
Working with Data Definitions	3-7
Practicing with IDDU	3-7

Part 2. Defining Data

Chapter 4. Working with Data Dictionaries	4-1
Creating a Data Dictionary	4-1
Securing a Data Dictionary	4-2
Describing a Data Dictionary	4-3

Maintaining a Data Dictionary	4-3
Chapter 5. Defining Files	5-1
Planning a File Definition	5-1
Creating a File Definition	5-5
Creating a Record Format for a File Definition	5-7
Selecting a Record Format for a File Definition	5-8
Maintaining File Definitions	5-9
Chapter 6. Defining Record Formats	6-1
Planning a Record Format Definition	6-1
Creating a Record Format Definition	6-4
Selecting a Field Definition	6-6
Maintaining Record Format Definitions	6-7
Chapter 7. Defining Fields	7-1
Planning a Field Definition	7-1
Basic Characteristics of All Field Definitions	7-5
Additional Characteristics for All Field Types	7-6
Additional Characteristics for Numeric Fields	7-8
Additional Characteristics for Character and DBCS Fields	7-9
Additional Characteristics for Date/Time/Timestamp Fields	7-10
Creating a Field Definition	7-12
Maintaining Field Definitions	7-14
Chapter 8. Working with Database Files	8-1
Creating a Database File	8-1
Securing a Database File	8-2
Entering Data into a Database File	8-3

Part 3. Maintaining Data, Definitions, and Dictionaries

Chapter 9. Field Editing Techniques	9-1
Edit Codes	9-1
Edit Code Table	9-2
Edit Word	9-3
Alias (Alternative Name)	9-4
Keyboard Shift and Data Type	9-4
Character Keyboard Shift	9-4
Numeric Keyboard Shift	9-6
DBCS Data Type	9-7
Date/Time Data Type	9-8
Chapter 10. Record Format Definition Considerations	10-1
Using Record Identification Codes	10-1
Chapter 11. File Definition Considerations	11-1
Selecting Key Field Sequence	11-1
Changing File Key Attributes	11-2
Changing Key Field Sequence Attributes	11-3
Chapter 12. Maintaining Definitions	12-1
Changing a Definition	12-1

Changing a File Definition	12-2
Changing a Record Format Definition	12-2
Changing a Field Definition	12-3
Exiting the Definition Process	12-4
Copying Definitions	12-4
Deleting Definitions	12-6
Printing Definitions	12-6
Renaming Definitions	12-10
Displaying Where Definitions Are Used	12-10
Recovering a Definition	12-11
Chapter 13. Maintaining Data Dictionaries	13-1
Changing a Data Dictionary	13-1
Deleting a Data Dictionary	13-2
Printing the Contents of a Data Dictionary	13-2
Other Dictionary Maintenance	13-3
Data Dictionary Recovery: Saving and Restoring	13-3
Copying a Data Dictionary	13-4
Renaming a Data Dictionary	13-4
Considerations When SQL/400 Users Share Dictionaries	13-4
SQL Terminology	13-4
SQL Definitions Used by IDDU	13-5
IDDU Definitions Used by SQL	13-5
Chapter 14. Maintenance Requiring Commands or Programming	14-1
Linking and Unlinking Files and Definitions	14-1
Creating Definitions from Files	14-1
Making Changes to Definitions That Affect Files	14-2
Changes Affecting Externally Described Files	14-3
Changes Affecting Program-Described Files	14-3
Creating a New Version of a Definition	14-4
Copying Data Files	14-5
Differences between Program-Described and Externally Described Files	14-6
Chapter 15. AS/400 Security and IDDU	15-1
Authority Requirements for IDDU Operations	15-1
Authority Requirements for Non-IDDU Dictionary Operations	15-2
Authority/Rights Table	15-2
Chapter 16. Dictionary Files	16-1
Data Dictionary Files	16-1
Associated Logical Files	16-1
Cross-Reference Files	16-2

Appendixes

Appendix A. Reviewing File Processing (Preparing for IDDU)	A-1
Current Operations	A-1
Manual File Processing Operations	A-1
Computer File Processing Operations	A-2
Analyze File Information	A-2
Field Design Considerations	A-3

Appendix B. Practice Exercise	B-1
Appendix C. Data Descriptions on the AS/400 System	C-1
Describing Data on the AS/400 System	C-1
Data Descriptions	C-1
Data Definitions	C-1
Dictionary Descriptions	C-2
Database Files on the AS/400 System	C-3
Files and Members	C-3
Program-Described Files	C-4
Externally Described Files	C-4
Appendix D. IDDU Commands	D-1
Appendix E. Differences between IDDU on the AS/400 System and System/36	E-1
Conceptual Differences	E-1
Operational Differences	E-1
Command Differences	E-2
Bibliography	H-1
Index	X-1

Figures

1-1.	Examples of Customer Data	1-1
1-2.	Example of Employee Records	1-1
7-1.	Date Format Options	7-11
7-2.	Time Format Options	7-11
12-1.	Example of All Information Printed for a File Definition	12-9
15-1.	Generic Levels of Authority with IDDU	15-1
15-2.	Generic Levels of Authority for Dictionary Operations	15-2
15-3.	Generic Authority Levels and Specific Rights	15-2

Notices

References in this publication to IBM products, programs, or services do not imply that IBM intends to make these available in all countries in which IBM operates. Any reference to an IBM product, program, or service is not intended to state or imply that only that IBM product, program, or service may be used. Subject to IBM's valid intellectual property or other legally protectable rights, any functionally equivalent product, program, or service may be used instead of the IBM product, program, or service. The evaluation and verification of operation in conjunction with other products, except those expressly designated by IBM, are the responsibility of the user.

IBM may have patents or pending patent applications covering subject matter in this document. The furnishing of this document does not give you any license to these patents. You can send license inquiries, in writing, to the IBM Director of Licensing, IBM Corporation, 500 Columbus Avenue, Thornwood, NY 10594, U.S.A.

Licensees of this program who wish to have information about it for the purpose of enabling: (i) the exchange of information between independently created programs and other programs (including this one) and (ii) the mutual use of the information which has been exchanged, should contact the software interoperability coordinator. Such information may be available, subject to appropriate terms and conditions, including in some cases, payment of a fee.

Address your questions to:

IBM Corporation
Software Interoperability Coordinator
3605 Highway 52 N
Rochester, MN 55901-7829 USA

This publication could contain technical inaccuracies or typographical errors.

This publication may refer to products that are announced but not currently available in your country. This publication may also refer to products that have not been announced in your country. IBM makes no commitment to make available any unannounced products referred to herein. The final decision to announce any product is based on IBM's business and technical judgment.

This publication contains examples of data and reports used in daily business operations. To illustrate them as completely as possible, the examples include the names of individuals, companies, brands, and products. All of these names are fictitious and any similarity to the names and addresses used by an actual business enterprise is entirely coincidental.

This publication contains small programs that are furnished by IBM as simple examples to provide an illustration. These examples have not been thoroughly tested under all conditions. IBM, therefore, cannot guarantee or imply reliability, serviceability, or function of these programs. All programs contained herein are provided to you "AS IS". THE IMPLIED WARRANTIES OF MERCHANTABILITY AND FITNESS FOR A PARTICULAR PURPOSE ARE EXPRESSLY DISCLAIMED.

Trademarks and Service Marks

The following terms, denoted by an asterisk (*) in this publication, are trademarks of the IBM Corporation in the United States or other countries or both:

Application System/400
AS/400
IBM
OfficeVision
OfficeVision/400
Operating System/400

OS/400
SAA
Systems Application Architecture
SQL/400
400

Microsoft, Windows, and the Windows 95 logo are trademarks or registered trademarks of Microsoft Corporation.

PC Direct is a trademark of Ziff Communications Company and is used by IBM Corporation under license.

UNIX is a registered trademark in the United States and other countries licensed exclusively through X/Open Company Limited.

C-bus is a trademark of Corollary, Inc.

Java and HotJava are trademarks of Sun Microsystems, Inc.

Other company, product, and service names, which may be denoted by a double asterisk (**), may be trademarks or service marks of others.

About IDDU Use (SC41-5704)

This book contains information on the concepts and procedures used in the AS/400 interactive data definition utility (IDDU) as well as information on maintaining and improving dictionaries, definitions, and database files.

Before you use this book, you must be familiar with the introductory material for using the AS/400 system, such as *System Operation for New Users*, SC41-3200. A knowledge of high-level programming languages is helpful, but not necessary to use IDDU.

If you want to use all of the AS/400 database capabilities, you must use data definition specifications (DDS) or the Structured Query Language (SQL). Read *DB2 for AS/400 Database Programming*, SC41-5701, for information about database design. Read the *DDS Reference*, SC41-5712, for information about DDS. Read the *DB2 for AS/400 SQL Reference*, SC41-5612, and *DB2 for AS/400 SQL Programming*, SC41-5611, for information about SQL.

For a list of related publications, see the Bibliography.

Who Should Use This Book

This book is written for persons using the OS/400 interactive data definition utility (IDDU) to define data to be used in queries and documents. Data definitions and data files created using IDDU are used by the data file utility (DFU), OfficeVision, Query/400, and Client Access/400.

Prerequisite and Related Information

For information about other AS/400 publications (except Advanced 36), see either of the following:

- The *Publications Reference* book, SC41-5003, in the AS/400 Softcopy Library.
- The *AS/400 Information Directory*, a unique, multimedia interface to a searchable database that contains descriptions of titles available from IBM or from selected other publishers. The *AS/400 Information Directory* is shipped with the OS/400 operating system at no charge.

Information Available on the World Wide Web

More AS/400 information is available on the World Wide Web. You can access this information from the AS/400 home page, which is at the following uniform resource locator (URL) address:

<http://www.as400.ibm.com>

Select the Information Desk, and you will be able to access a variety of AS/400 information topics from that page.

Part 1. Introduction to Data Definition

This part first introduces computer file concepts and establishes the relationships between the information used in a business and the data that is handled by a computer. Then it discusses the concepts of data dictionaries and data definitions as created by the interactive data definition utility (IDDU). Finally, it tells how to start and use IDDU to describe the data you will use in queries and documents.

Information on creating elements in the process (data dictionary, field/format/file definitions, and the database file) is discussed in "Part 2. Defining Data."

Chapter 1. File Concepts

Before you read about how to use the interactive data definition utility (IDDU) for describing your data in the AS/400* system, you should understand what data is and how it is stored on the computer system.

Data is simply the information used in your business: customer names, account balances, part numbers, and so forth. The data in your business can be kept in a variety of ways and used for a variety of purposes.

For example, you may keep names and addresses and other information about customers in an alphabetical arrangement of index cards, like this:

A-12345 Smith Company Mr P W Bonner PO Box 9753 Chicago, IL 22334-4567 (516) 032-5654	A-34567 STN Company Mr Alex Jones 1717 44 Street New York, NY 65053-5678 (201) 045-8675	B-56789 TUVW Corp. Ms J Stiles 5555 33 Ave. Chicago, IL 22334-6789 (516) 024-1222
---	---	---

Figure 1-1. Examples of Customer Data

You might use these names and addresses to:

- Address envelopes for a large mailing
- Type personalized letters as part of an advertising campaign
- Type reports summarizing different types of accounts

Or you may keep employee records for your company or department arranged on a sheet of paper, like this:

Figure 1-2. Example of Employee Records

Serial Number	Hiring Date	Name	Street Address	City	State	Zip Code	Telephone
02841	11/12/89	Susan P Gantner	907 Abbey Hwy	Mushroom Manor	OR	67891	617 334-5551
12381	07/31/88	Perry C Swenson	19821 Metro Hwy	St. Paul	OR	67891	617 334-1515
23119	02/24/87	Matt F Thomas	961 S 19th Ave	Piney Island	OR	67890	617 235-5151

You might use this information to:

- Supply address and telephone lists
- Type letters relating to a company event
- List days of vacation or absence for each employee
- Supply employee lists by department or job title

Whether stored on the computer or on paper in your office file drawer, data is organized into fields, records, and files.

Fields

A single item of data is called a **field**. For example, *A-12345* on the index card is data in the account number field; *907 Abbey Hwy* on the employee list is data in the street address field:

```
A-12345 - - - - - Account number field
Smith Company
Mr P W Bonner
PO Box 9753
Chicago, IL
22334-4567
(516) 032-5654
```

Serial Number	Hiring Date	Name	Street Address	City
02841	11/12/89	Susan P Gantner	907 Abbey Hwy	Mushroom Manor

Records

A **record** is a collection of fields that holds information about a particular subject. For example, each index card is a name-and-address record of a particular customer; each line on the list is a record of a particular employee:

Customer Record

```
A-12345
Smith Company
Mr P W Bonner
PO Box 9753
Chicago, IL
22334-4567
(516) 032-5654
```

Employee Record

Serial Number	Hiring Date	Name	Street Address	City
02841	11/12/89	Susan P Gantner	907 Abbey Hwy	Mushroom Manor

Files

A **file** is a set of related records. For example, the stack of index cards with information on each of your customers makes up a file; so do all the pages of employee information.

File Storage

Computer files are magnetically recorded on specific areas of disk storage, somewhat like tracks on a phonograph album, so they take up considerably less space and are less easily damaged than the paper files in your cabinet drawer.

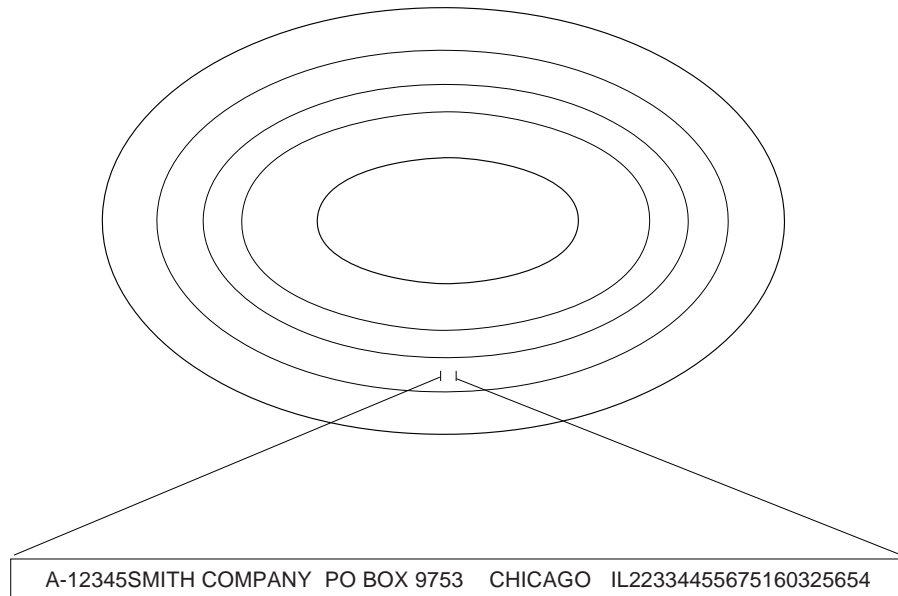

RSLL270-0

The specific areas of storage that hold files on this system are called **libraries**, which could be compared to the drawer or cabinet holding the file folders in your office.

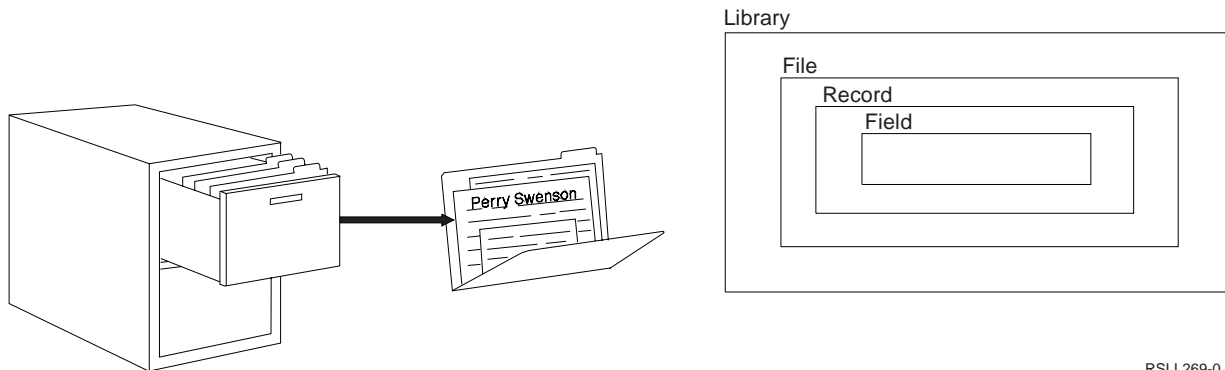

RSLL269-0

File Processing

File processing includes recording, classifying, sorting, calculating, storing, selecting, retrieving, reproducing, reporting, communicating, and distributing data to perform tasks required in your business.

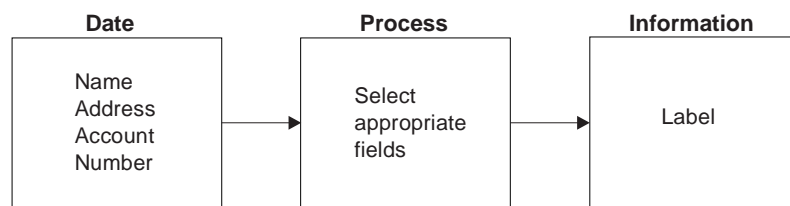

RSLL259-0

Your work with files could include the tasks described in the following sections.

Using Data in Documents

The word processing function of the IBM® Systems Application Architecture® (SAA®) OfficeVision® program (if it is installed on your system) allows you to merge data from your files into your text documents. Information on preparing documents is in *Using OfficeVision/400 Word Processing*.

Combining Data and Text: A name and address are taken from a file and combined with a form letter.

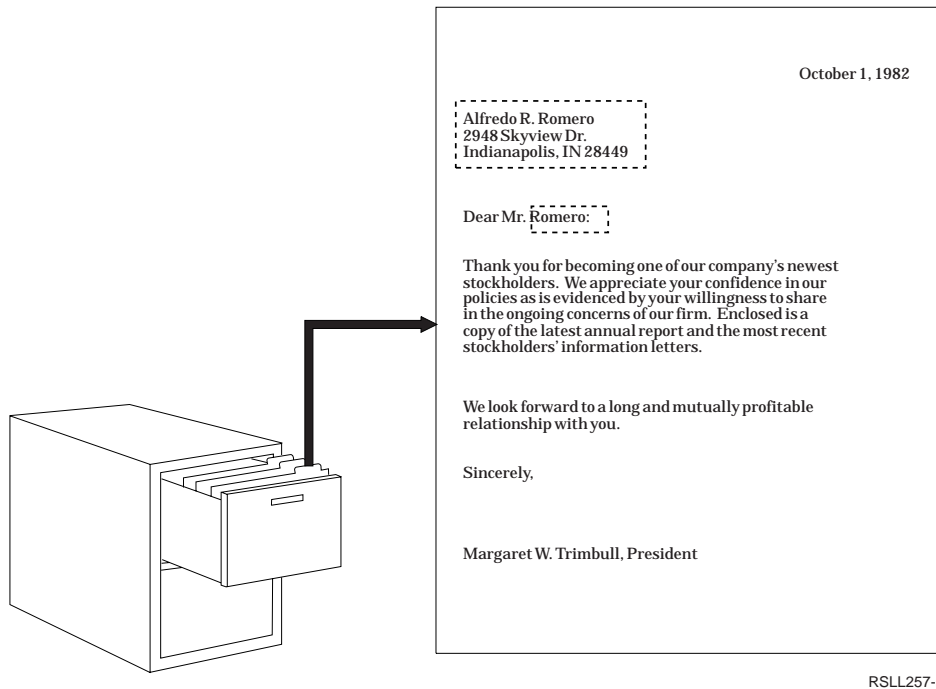

Querying Data

You can request information from your files (such as search for, select, and list particular records) using the AS/400 Query program (if it is installed on your system). Information on writing queries is in the *Query/400 Use* book.

Looking at Each File Record: You need to find an employee's hiring date.

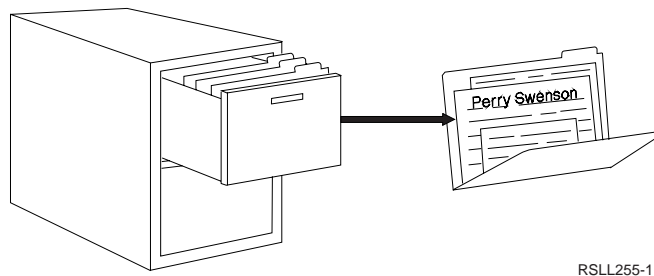

Listing All the File Information: You need to print a list of all your customers.

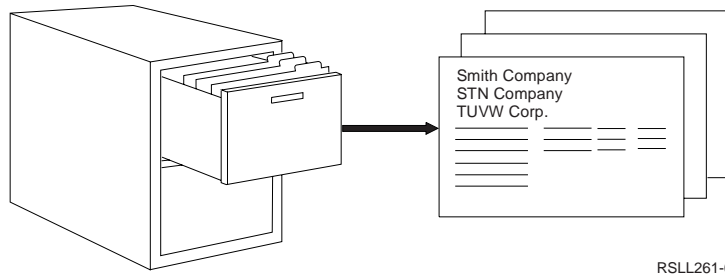

Selecting Records: You need to print a list of all your New York customers.

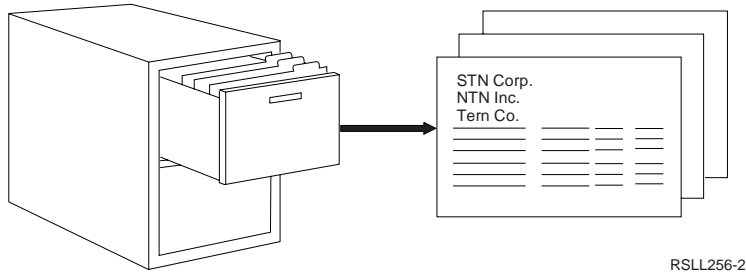

Maintaining Data

Adding, changing, and deleting records are all file maintenance activities. You can do this work on the AS/400 system using a part of the AS/400 Application Development Tools (if they are installed on your system) called the data file utility (DFU). Information on maintaining data files is in the *ADTS/400: Data File Utility* book.

Adding Records to a File: A new employee name must be added to the employee file in the proper alphabetic sequence.

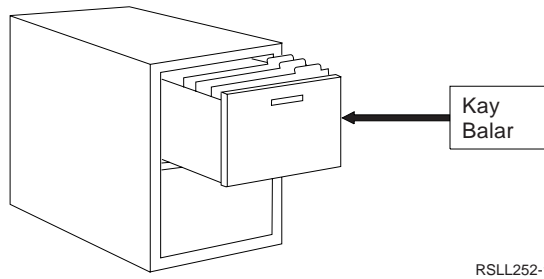

Changing Records: An employee's address must be changed.

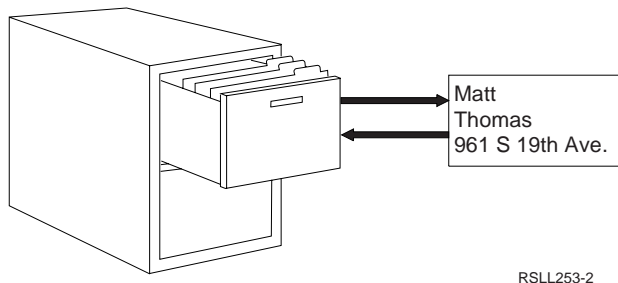

Deleting Records: An outdated record should be removed from the file.

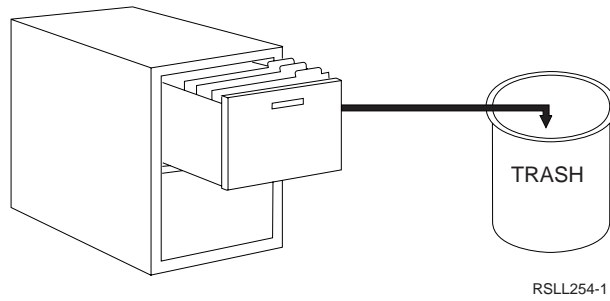

RSL254-1

Describing Data

Before you can use any of the programs just mentioned to work with your data, you must describe (or define) that data to the system. The next chapter describes the concepts of defining data to be used in queries and documents.

Chapter 2. Data Definition Concepts

Any program that uses a file requires some sort of description of that file and the data in it. Just as you might tell someone in your office to look for the account number in the upper left corner of an index card, you must also tell the computer where your data starts, where it ends, whether it is numbers or letters, and so forth.

For example, a description of data on a customer's account balance would include at least such information as:

- The name of the field (perhaps BALANCE)
- How long the field is (probably seven positions, to contain numbers up to 99 999.99; the separators are added later)
- Where among the other fields in the record this field is located (for example, after account number but before company name)
- What type of data the field contains (numeric, in this case)
- Whether the data includes a decimal point, and if so, how many positions (typically two)

Depending on how one is using the system, there are several methods of describing data:

- Using statements within an application program written in a high-level language such as RPG or COBOL. Data described in a program is known as **program-described data**.

With this method, the file and the descriptions of its data are known only to that application program; they cannot be used by any other program on the system. Each program that refers to a file must contain its own set of file and data descriptions.

- Using system functions (such as DDS or IDDU) to create data descriptions (or definitions) and keep them with the file they describe. Data described outside of an application program is known as **externally described data**.

With this method, the data descriptions can be shared by all programs using that file.

When the interactive data definition utility (IDDU) is used to describe data, it collects the **data definitions** that it produces into a **data dictionary**.

Database Files

A database is a collection of data files in the system that are described together in one place using a common method of description that allows them to be used by more than one program. Individual data files thus described are sometimes also called **database files**.

Data Dictionaries

Just as a word dictionary contains definitions of the words used in a language, a **data dictionary** contains definitions of the data stored on your system. A single data dictionary could contain definitions of all the files, records, and fields used on your system. Or several separate data dictionaries could define the data used by different applications. You could, for example, have one data dictionary for customer account applications and another for employee applications.

Dictionaries, Libraries, and Files

You can have as few or as many dictionaries as your business needs, but each must be stored in a separate library on the system (and each has the same name as its library). The actual data files can, but need not, be in the same library as the data dictionary that describes them.

Library 1

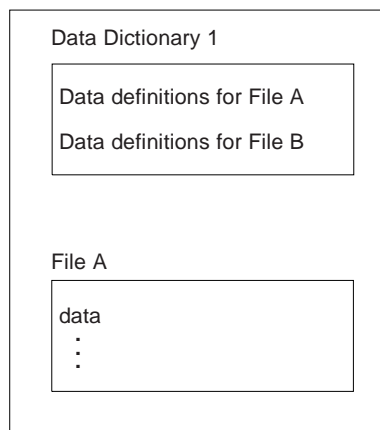

Library 2

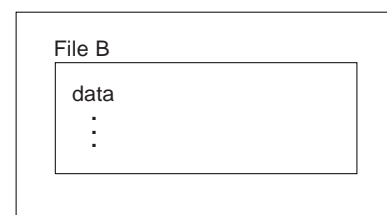

RSLL265-0

Advantages of a Data Dictionary

With a data dictionary, you can reduce the number of times you describe data to your system because the data definitions are reusable; once you have defined a street address field, for example, you can use that field definition in any record format definition that describes a record containing street addresses.

And if you need to change an attribute of a field (for example, if your customer account numbers now include alphabetic characters as well as numbers), you have fewer definitions to change, and they are all in one place.

The dictionary also keeps track of where definitions are used and what files they describe. Thus you can delete definitions that are not used or perhaps protect a definition used in a special way in a particular file.

Data Definitions

Remember, the dictionary does *not* contain the data itself. Instead, it contains information about various aspects of the data: location, format, attributes, structure, use, and relationships.

Because data is organized into files, records, and fields, a data dictionary contains three kinds of data definitions:

- Field definitions
- Record format definitions
- File definitions

Field Definitions

Fields are single pieces of information within a computer record, similar to each of the areas on an invoice. **Field definitions**, then, are the instructions that tell you important information about the fields in a record:

What kind of data does the field contain, numbers or letters?

How long is the field? If the field contains a number, how many positions follow the decimal point?

How is data in the field printed or displayed? What is the thousands separator? What is the currency symbol? Where is the minus sign shown?

Record Format Definitions

A **record format definition** lists the fields in the record and identifies the order in which the fields appear.

You can compare a record format definition to instructions that describe the kinds of information in a document. An invoice, for example, contains blanks that someone must fill in, such as a customer's name and address. In effect, a record format definition supplies the blank form for a computer record.

Record Format

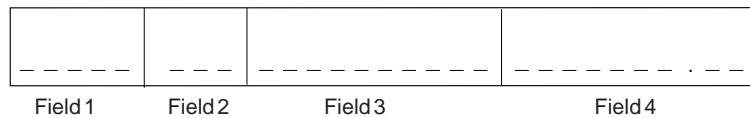

RSLL266-1

File Definitions

A **file definition** identifies the kinds of records contained in a computer file.

Just as we compared a computer file to a folder in a cabinet drawer, you can compare a file definition to labels that describe the kinds of documents contained in the folder.

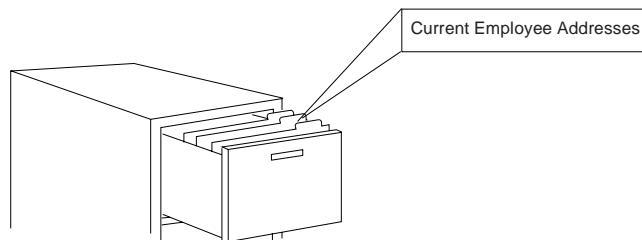

RSLL267-1

How Do All These Definitions Fit Together?

Just as fields and records fit together to form data files on your system, data definitions work together to define those files. Field definitions are grouped together to form record format definitions (and are often used in more than one format), and then record format definitions are grouped together to form file definitions, as shown in this illustration:

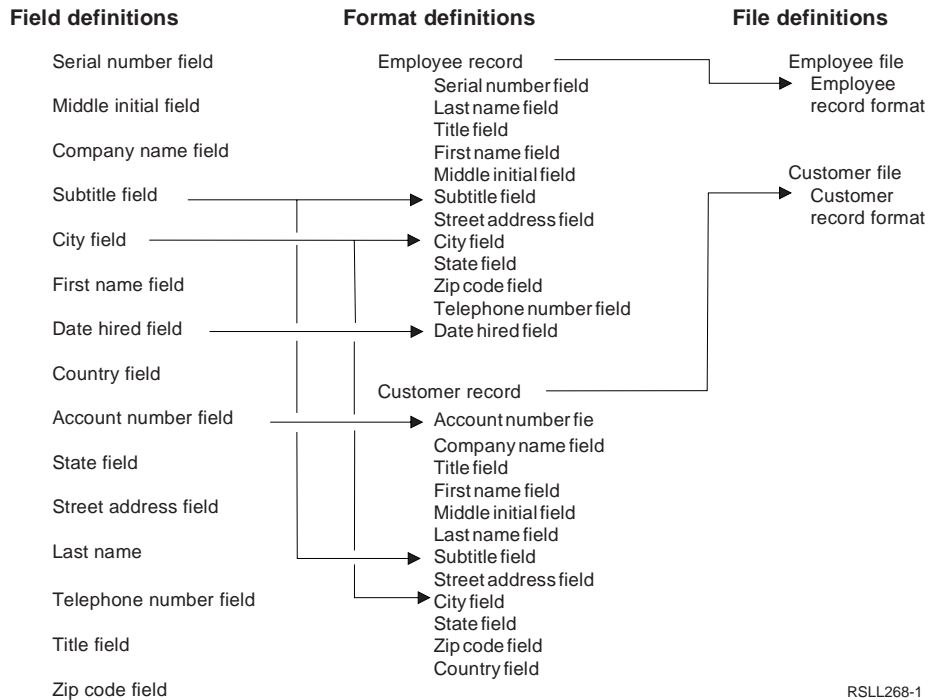

The Operating System/400* (OS/400*) program that helps you do this grouping is the interactive data definition utility (usually called IDDU).

Interactive Data Definition Utility (IDDU)

The **interactive data definition utility (IDDU)** is a program that guides you through the steps required to describe (define) the characteristics of data and the contents of files stored on your system and to maintain those data definitions in data dictionaries.

The term *interactive* (in the program's name) is defined as *pertaining to the exchange of information between people and a computer*, and to you that means when you give the program some piece of information, it responds immediately and appropriately. For example:

If you type a 3 on the Select Definition Type display to indicate that *File* is the definition type you want, IDDU takes you directly to the Work with File Definitions display.

If you specify that the field type is *Character*, IDDU shows you only the additional prompts required for character data; you don't have to page through all the displays that define numeric data.

If you make an error entering data on a display, IDDU displays a message telling you what is wrong as soon as you press the Enter key, so you can quickly correct the mistake and proceed with your task.

IDDU Features

IDDU also includes a number of other features that make it easy to work with data dictionaries and data definitions:

- **Prompts**

You can respond to people-language phrases instead of remembering somewhat obscure commands and keyword parameters; for example, *Definition type* instead of DFNTYPE (type), *Data dictionary* instead of DTADCT (name).

```

                                Select Definition Type
Type choices, press Enter.
Definition type . . . . . _          1=Field
                                       2=Record format
                                       3=File
Data dictionary . . . . . default__ Name, F4 for list

```

- **Assumed choices (defaults)**

You can accept IDDU's best guess as the most common response to a prompt and only type a choice when you want something different. For example, *packed* is the assumed choice for numeric data type, but you can specify one of three others instead.

```

                                Numeric Field Options
Definition . . . . . : XXXXXXXXXX      Dictionary . . . . . : XXXXXXXXXX
Type choices, press Enter.
Numeric data type . . . . . 2  1=Zoned, 2=Packed
                               3=Binary, 4=Floating point
Column headings:
Heading 1 . . . . . _____
Heading 2 . . . . . _____
Heading 3 . . . . . _____

```

- **Lists**

You can select from a list of all the available items instead of having to remember and type names.

Opt	Field Definition	Date	Text
-	ACCOUNTNUM	10/19/87	Customer account type and number (x-nnnnn)
-	COMPANY	10/19/87	Customer's company name
-	DATE	10/02/87	(mmddy)
-	FIRSTNAME	10/08/87	Employee's given name
-	LASTNAME	10/08/87	Employee's surname
-	SERIALNUM	10/08/87	Employee's serial number (nnnnnn)
-	TELEPHONE	10/02/87	Area code + phone number (nnn-nnn-nnn)
F3=Exit		F5=Refresh	F10=Work with database files
F11=Display names only		F12=Cancel	F22=Work with data dictionaries

- **Function keys**

You can press a single key instead of learning and typing lengthy or cryptic command instructions.

Data dictionary . . . _____	Name, F4 for list	
F3=Exit	F4=Prompt	F10=Work with database files
F12=Cancel	F22=Work with data dictionaries	

- **Online information**

You can request and read information about IDDU and the system right at your display station instead of having to keep this and other books nearby.

Type (Field type)
Type the appropriate number to indicate which type of field definition you are creating.
1 = Character will create an alphanumeric field.
2 = Numeric will create a packed numeric field

Online information includes:

- Help information (brief reminders about specific displays, prompts, options, and keys)
- Index search information (more detailed explanations of concepts and tasks)
- Error recovery information (additional information on messages: what happened, whether you did something wrong, and what to do about it)

IDDU Capabilities

Using IDDU, you can create new data dictionaries or data definitions (described in Chapter 4, “Working with Data Dictionaries” through Chapter 7, “Defining Fields”), and do any of the following (described in Chapter 12, “Maintaining Definitions” and Chapter 13, “Maintaining Data Dictionaries”):

- Change existing data dictionaries or data definitions.
- Copy definitions from one data dictionary to another, or within the same data dictionary.
- Delete data definitions from a data dictionary, or delete an entire data dictionary.
- Print the information contained in a single data definition or in all data definitions of a certain type (for example, all field definitions) that are in a data dictionary.
- Rename a data definition.
- Show which other data definitions and files use a particular data definition.

You can also work directly with database files through IDDU (as described in Chapter 8, “Working with Database Files”):

- Create a new database file based on an existing file definition and its format and field definitions.
- Add or change data in a database file.

You can perform additional IDDU-related tasks using the commands listed in Appendix D, “IDDU Commands.”

Using Data in Queries and Documents

To use your data in queries or documents, you must first have a library so you have a place for your data dictionary and database file.

Note: Information on writing queries to request information from your files is in *Query/400 Use*. Information on preparing documents is in *Using OfficeVision/400 Word Processing*.

Use IDDU to describe (or choose):

- A dictionary (so you have a place for your data definitions)
- File definitions (so you can tell the system what your data looks like)
- Record format definitions (so you can select which to put in your file definition)
- Field definitions (so you can select the ones to put in the record format definition)

Then you can select options from the IDDU menu to create:

- A database file (so you have a place to put your data)
- Data in the file (so your applications have something to work with)

The following chapter summarizes the process of using IDDU to describe a data dictionary and data definitions for an application and “Part 2. Defining Data” on page 3-9 describes each part of the process in more detail. If you are responsible for maintaining the database and data dictionaries, you can find additional informa-

tion about these tasks in “Part 3. Maintaining Data, Definitions, and Dictionaries” on page 8-5.

Chapter 3. Getting Started

This chapter tells you how to get to the interactive data definition utility (IDDU) on the system and generally how the program takes you through the typical tasks required to describe your data to use in queries and documents.

Getting to IDDU

You can get to the Interactive Data Definition Utility (IDDU) menu by either of two menu paths, starting at the AS/400 system Main Menu and selecting the following options:

Path 1

1. On the Main Menu, choose option 2 (Office tasks).
2. On the Office Tasks menu, choose option 3 (Decision support).
3. On the Decision Support menu, choose option 1 (IDDU).

Path 2

1. On the Main Menu, choose option 4 (Files, libraries, and folders).
2. On the Files, Libraries and Folders menu, choose option 1 (Files).
3. On the Files menu, choose option 5 (IDDU).

Or you can enter one of the following on any command line to go directly to the Interactive Data Definition Utility (IDDU) menu:

STRIDD (a command that means Start IDDU)

GO IDDU (a command that means Go to the IDDU menu)

If you prefer not to use the menu paths, you can use the commands listed in Appendix D, "IDDU Commands," to go directly to individual IDDU displays.

Interactive Data Definition Utility (IDDU) Menu

This is the main menu for IDDU. Choosing one of the options will bring up displays related to that choice.

```
IDDU                Interactive Data Definition Utility (IDDU)

Select one of the following:

    1. Work with data definitions
    2. Work with data dictionaries
    3. Work with database files

    20. Work with libraries
    21. Work with files

    30. Office tasks

    70. Related commands

Selection or command.
====> _____

F3=Exit  F4=Prompt  F9=Retrieve  F12=Cancel  F13=User Support
F16=System main menu
```

Using Function Keys

From all IDDU (and system) menus and displays, you press the Enter key to tell the system that you have completed your work for that display. You can also use function keys (labeled F_n , where n is a number, like F_3) to end your work, to get more or different information, or to go to a different display. To see explanations of the function keys, prompts, or options on a display, press the Help key or F_1 (Help).

Choosing Options

From the IDDU menu, you can choose which of the data tasks (options 1, 2, and 3) you want to do. You can also choose to do related tasks (options 20, 21, and 30) or to look at or use the related IDDU commands (option 70).

Work with ... Displays

When you choose an option from the IDDU menu, you see a display showing the various ways you can work with that object (for example: files, programs, libraries, and folders).

Note: In some cases, you might first see a display allowing you to be more specific in your choice. For example, if you choose option 1 (Work with data definitions) on the IDDU menu, you first see the Select Definition Type display, where you can specify whether you want to work with field, record format, or file definitions.

Then you see the appropriate Work with ... display:

```

                                Work with File Definitions
Dictionary . . . . . : xxxxxxxxxx
Position to . . . . . _____ Starting characters
Type options (and File Definition), press Enter.
  1=Create  2=Change  3=Copy  4=Delete
  6=Print   7=Rename  8=Display where used

  File      File      File      File
  Opt  Definition  Opt  Definition  Opt  Definition  Opt  Definition
  -    -          -    -          -    -          -    -
  -    AAxxx      -    BCxxx      -    CExxx      -    EBxxx
  -    ABxxx      -    BDxxx      -    DAxxx      -    ECxxx
  -    ACxxx      -    BExxx      -    DBxxx      -    EDxxx
  -    ADxxx      -    CAxxx      -    DCxxx      -    EExxx
  -    AExxx      -    CBxxx      -    DDxxx      -    FAxxx
  -    BAxxx      -    CCxxx      -    DExxx      -    FBxxx
  -    BBxxx      -    CDxxx      -    EAxxx      -    FCxxx
                                          More...
F3=Exit      F5=Refresh   F10=Work with database files
F11=Display text  F12=Cancel   F22=Work with data dictionaries

```

To do a task from any of the Work with ... displays, choose the task you want to do and type the corresponding option number next to the object you want to work with (a file definition, in the example display).

Using Lists

The names of all the available objects of the type you are working with are shown in alphabetic order. (If the word *More...* appears in the lower right corner of the list, you can see additional names by pressing the Page Down key.) If you want to quickly find a name appearing later in the list, you can type the starting characters of the name in the input field for the *Position to* prompt. The list then shifts so that the first name starting with that character is shown in the upper left corner of the list. For example, if you specified *SA* for the *Position to* prompt, the newly positioned list would look like this:

```

                                Position to . . . . . _____ Starting characters
Type options (and File Definition), press Enter.
  1=Create  2=Change  3=Copy  4=Delete
  6=Print   7=Rename  8=Display where used

  File      File      File      File
  Opt  Definition  Opt  Definition  Opt  Definition  Opt  Definition
  -    -          -    -          -    -          -    -
  -    SAxxx      -    TCxxx      -    UExxx      -    WBxxx
  -    SBxxx      -    TDxxx      -    VAxxx      -    WCxxx
  -    SCxxx      -    TExxx      -    VBxxx      -    WDxxx
  -    SDxxx      -    UAxxx      -    VCxxx      -    WExxx
  -    SExxx      -    UBxxx      -    VDxxx      -    XAxxx
  -    TAxxx      -    UCxxx      -    VExxx      -    XBxxx
  -    TBxxx      -    UDxxx      -    WAxxx      -    XCxxx
                                          More...
F3=Exit      F5=Refresh   F10=Work with database files
F11=Display text  F12=Cancel   F22=Work with data dictionaries

```

If you need more information than just the object name to make your choice, you can press F11 (Display text) to see an expanded list, like this:

Opt	File Definition	Date	Text
-	SAxxx	mm/dd/yy	xx
-	SBxxx	mm/dd/yy	xx
-	SCxxx	mm/dd/yy	xx
-	SDxxx	mm/dd/yy	xx
-	SExxx	mm/dd/yy	xx
-	TAxxx	mm/dd/yy	xx
-	TBxxx	mm/dd/yy	xx
			More...
F3=Exit		F5=Refresh	F10=Work with database files
F11=Display names only		F12=Cancel	F22=Work with data dictionaries

If you want to go back to the other kind of list, you can again press F11 (Display names only).

Choosing Multiple Options

You can specify more than one task from a list, because in front of each name in the list is an input field where you can type the option number of the task you want to do with that item. Also, at the beginning of the list is a space where you can type the name of an item and an option number for that item.

After you press the Enter key, IDDU presents displays to do the tasks in the order the options are specified on the list. For example, if you specified the following multiple options, you would first see the appropriate series of displays to create a new file definition named GEORGE, then the displays to change file definition ABxxx, then displays to rename file definition BExxx, then displays to delete file definition DDxxx, and so forth.

Type options (and File Definition), press Enter.

1=Create 2=Change 3=Copy 4=Delete
6=Print 7=Rename 8=Display where used

Opt	File Definition	Opt	File Definition	Opt	File Definition	Opt	File Definition
1	GEORGE						
-	AAxxx	-	BCxxx	-	CExxx	-	EBxxx
2	ABxxx	-	BDxxx	-	DAxxx	2	ECxxx
-	ACxxx	7	BExxx	-	DBxxx	-	EDxxx
-	ADxxx	-	CAxxx	-	DCxxx	-	EExxx
-	AExxx	-	CBxxx	4	DDxxx	6	FAxxx
-	BAxxx	-	CCxxx	-	DExxx	-	FBxxx
-	BBxxx	-	CDxxx	-	EAXxx	-	FCxxx
							More...
F3=Exit		F5=Refresh		F10=Work with database files			
F11=Display text		F12=Cancel		F22=Work with data dictionaries			

IDDU Displays to Create or Change Objects

When you choose the options to create or change a dictionary or data definition, you first see a display on which you enter information required for all objects of that type. The information required for creating or changing an object is very similar.

For example, if you choose to create new field definitions, you see the Create Field Definitions display.

```

                                Create Field Definitions

Type information, press Enter to create.
Field type (size) . . . : 1=Character (1-32766)
                        2=Numeric (1-31, decimal positions 0-31)
                        3=DBCS (4-32766, mixed; 1-16383, graphic)
                        4=Date/Time (no size)
More options. . . . . : Y=Yes

-----Field-----  Dec  More
Name      Type Size  Pos  Opt  Text
-----
_____ - _____ - - - _____
_____ - _____ - - - _____
_____ - _____ - - - _____

```

Using the codes shown at the top of the display, you can type descriptions for nine fields at a time, specifying for each what kind of field it is, its length, how many positions after its decimal point (if it is a numeric field), a brief description, and whether you want to specify more information about it on following displays. After you press the Enter key, you are shown all appropriate additional displays (if any) for the first field you specified, then all displays for the second field, and so forth.

To specify additional information about the field, you enter a Y under the *More Opt* heading. The additional options for all field types include column headings, a long comment, and keyboard control for input. For numeric fields, you can also specify the type of numeric data and how (or if) you want the field to be edited (that is, have commas, decimal points, currency symbols, and so forth inserted around the numbers).

If you specify that you want more options for a character field, you see a display like this:

```

                                Character Field Options

Definition . . . . . : xxxxxxxxxx      Dictionary . . . . . : xxxxxxxxxx

Type choices, press Enter.

Hexadecimal
data type . . . . . N      Y=Yes, N=No

Column headings
Heading 1 . . . . . _____
Heading 2 . . . . . _____
Heading 3 . . . . . _____

Null attribute . . . . . 3      1=Null, 2=Not Null
                                3=Not null with default

Variable length . . . . . N      Y=Yes, N=No

Allocated length . . . . . ___0  0-32740 characters

F3=Exit  F12=Cancel

More...

```

```

                                Character Field Options
Definition . . . . . : xxxxxxxxxx      Dictionary . . . . . : xxxxxxxxxx
Type choices, press Enter.

Keyboard shift for
display file reference . . . . . _      1=Select, 4=Remove

Long comment . . . . . 1      1=Select, 4=Remove

Alternative name (Alias) . . . . . _____

Coded Character Set
Identifier (CCSID) . . . . . _____ 1-65535

```

Notice that the choices for several prompts on the above display are *Select* or *Remove* instead of actual values. This technique helps you control the number of displays you must page through as you create or change definitions. You only see additional displays to enter new or different information if you specify *Select* for these prompts. Or, you can leave the prompt blank and IDDU keeps the existing information for that prompt. If you do not remember what information currently exists, you can specify *Select* to see the next display.

Creating Data Definitions

The process of creating data definitions happens in this sequence:

1. Before you create any data definitions, you must first have a data dictionary for them.
2. Then you define your fields, record format(s), and file.

Because defining record formats and files mostly consists of selecting definitions to be included, you must first have definitions to select from. You can either build all the necessary definitions, starting with the fields, and then assemble them; or you can start with the file definition and create the others as the displays ask for them.

The first method may be easier to follow if you have many new definitions to create or if you are relatively inexperienced with IDDU. You may find the second method somewhat faster if you already have most of your definitions created and ready to select from or if you are familiar with IDDU.

3. Finally, after you have the necessary definitions in your dictionary, you can create the file and enter data into it.

The chapters in “Part 2. Defining Data” on page 3-9 are arranged in the creating sequence: first, dictionaries; then, file definitions, format definitions, and field definitions; and finally, database files. Each chapter gives the information you need to plan and create that kind of object.

Working with Data Definitions

Besides creating new definitions, you can also copy existing definitions between or within dictionaries, change them as needed, rename them, delete them, print or display them, and show where they are used. Chapter 12, “Maintaining Definitions” describes these tasks.

Practicing with IDDU

If you would like to practice trying IDDU before you use it to describe your own data, a practice exercise is included in Appendix B, “Practice Exercise” that should help you get acquainted with the tasks of data definition. Also, if you would like more information on analyzing and describing the files in your office, you might find Appendix A, “Reviewing File Processing (Preparing for IDDU),” helpful.

Part 2. Defining Data

This part provides information on how to plan for and define data using IDDU, and assumes the concepts in “Part 1. Introduction to Data Definition” are understood. It describes the tasks related to creating data dictionaries and definitions for files, record formats, and fields. Also, this part discusses creating database files using IDDU definitions and entering data into database files using DFU.

Tasks for maintaining definitions and dictionaries (including copying, changing, printing, and deleting) are discussed in “Part 3. Maintaining Data, Definitions, and Dictionaries.”

Chapter 4. Working with Data Dictionaries

Data dictionaries allow you to create definitions of fields, formats, or files once, so that the definitions can be used many times to describe different files. For example, a billing department and a sales department both use the same customer information when creating documents to send to people. If one person creates the definition, many people can use it.

While a dictionary and the applications that use its definitions do not have to be in the same library, you must create a data dictionary if you not yet have one. Each dictionary has the same name as the library that contains it.

Creating a Data Dictionary

You can create a data dictionary in any library on the system to which you have the proper level of authority. You can either use the Work with Data Dictionaries display or type the Create Data Dictionary (CRTDTADCT) command on any command line. Remember, a library can have only one data dictionary.

You might want to create more than one data dictionary for your area. You might create different data dictionaries for different types of data: for example, one data dictionary to describe inventory information and another to describe employee information.

Note: The dictionary creator has the authority to limit who can work in each data dictionary and what kind of work they can do.

You need to do the following steps to create a data dictionary:

1. Choose option 2 (Work with data dictionaries) from the IDDU menu (or type WRKDTADCT on a command line).
2. On the Work with Data Dictionaries display, choose option 1 (Create) and type the name of the dictionary (which is the same as the name of the library that will contain the dictionary).

```
Work with Data Dictionaries
Position to . . . . . _____ Starting characters
Type options (and Data Dictionary), press Enter.
  1=Create  2=Change  4=Delete  6=Print
Data      Data      Data      Data
Opt Dictionary  Opt Dictionary  Opt Dictionary  Opt Dictionary
1  ACCOUNTS
```

Note: If the library you specify does not exist, the system shows you the Create a Library display (if you are authorized to create libraries). After you create a library from that display, you continue to the Create a Data Dictionary display.

3. On the Create a Data Dictionary display, the name of the specified library appears as the name of the dictionary.

```

                                Create a Data Dictionary
Dictionary . . . . . : ACCOUNTS
Type choices, press Enter.
Authority . . . . . *LIBCRTAUT *LIBCRTAUT, *ALL, *CHANGE,
                                *USE, *EXCLUDE
                                Authorization list name
Long comment . . . . . _          1=Select, 4=Remove
Text . . . . . _____

```

From this display, you can:

- a. Choose the authority others have with this dictionary.
 - b. Choose whether to provide an extended description (long comment) for this dictionary.
 - c. Type a brief text description of the dictionary.
4. If you choose 1 (Select) for the *Long comment* prompt, the Edit a Long Comment display appears next. There you can type as detailed a description of this dictionary as necessary.
 5. After you finish the display(s), the system creates the dictionary and sends you a completion message. (This process can take some time.)

Considerations for securing (assigning authority to) and describing a dictionary are discussed in the following topics.

Securing a Data Dictionary

For security reasons, consider controlling the access other users will have to your dictionaries. The *Authority* prompt on the Create a Data Dictionary display allows you to specify how much control other users have over the contents of the dictionary. (See “Changing a Data Dictionary” on page 13-1 for information on making changes in authority.)

For more information about resource and office security, see the books *Security – Reference* and *Managing OfficeVision/400*.

Levels of Authority

You can grant the following access, or levels of authority, to other users when you create a dictionary:

***LIBCRTAUT**

A user can be allowed or denied the authority to use the object created using the Create Authority (CRTAUT) value in the library in which the object is being created.

***ALL**

All users can work with the definitions in this dictionary, including changing them, and can change others' authority to the dictionary, subject to additional individual security restrictions.

***CHANGE**

All users can work with the definitions in this dictionary, including changing them, but cannot change authority to the dictionary.

***USE**

All users can copy and print definitions from the dictionary and display where they are used but cannot change the dictionary or its definitions.

***EXCLUDE**

No other user has any access to this dictionary.

Authorization Lists

If you want different users to have different levels of authority, you can specify the name of a user-created authorization list containing the names of specific users to be authorized to this dictionary and the authority level for each individual. The authorization list must already exist on the system before you create the dictionary. Refer to *Security – Reference* for details.

Describing a Data Dictionary

You can describe the content, the purpose, or other information about a dictionary by using the *Long comment* and *Text* prompts.

Long Comment

The *Long comment* prompt lets you enter, on the Edit a Long Comment display, up to 1360 characters of information about the dictionary. Examples of this information might be identifying the files defined by this data dictionary, or identifying who created the dictionary and who is responsible for maintaining it. The information you put in the long comment can be read on the edit display when you choose to change the dictionary and printed by using the Print key (or other methods of printing a copy of displays).

Text Description

The *Text* prompt lets you write a short description (up to 50 characters) about the dictionary that may be helpful in reminding you of the purpose and contents of the dictionary. The information you put in the text field is shown in lists of dictionaries and can be printed by using the Print key (or other methods of printing a copy of displays).

Maintaining a Data Dictionary

Besides creating a data dictionary, you can also work with dictionaries in other ways. You can:

- Change a dictionary you have authority over.
- Delete a dictionary you have authority over.
- Print information about a dictionary.

These dictionary maintenance tasks are described in Chapter 13, “Maintaining Data Dictionaries.”

Chapter 5. Defining Files

This chapter describes how to plan for, create, and maintain file definitions. A file definition has at least one record format definition that describes the records in the file.

Planning a File Definition

When you are planning to create (or change) a file definition, you may find it helpful to use a work sheet to organize the description of the file and then refer to the work sheet as you go through the interactive data definition utility (IDDU) displays.

An example of a file definition work sheet, including the most commonly used file definition prompts on the displays, is supplied on the following page. You can copy and use this work sheet, or you may want to create one designed for your own applications.

The descriptions that follow the work sheet will help you in completing it.

File Definition Work Sheet

Data Dictionary Name _____

File definition name _____ (up to 10 characters)

Record format definition name(s)

_____ New or existing definition? _____

_____ New or existing definition? _____

_____ New or existing definition? _____

Key field name(s)

_____ Ascending or descending? _____

_____ Ascending or descending? _____

_____ Ascending or descending? _____

Long comment (up to 1360 characters)

Text _____ (up to 50 characters
of description)

Data Dictionary Name

This is the name of the data dictionary that will contain this file definition. It is the same as the name of the library containing the dictionary.

File Definition Name

The name of the file definition you are creating can be up to 10 characters.

You can begin a file definition name with any alphabetic character (A through Z) or one of the symbols \$, #, @. You can also use any of those characters and symbols for the remainder of the name, as well as the numbers 0 through 9, the period (.), and the underscore character (_).

However, an extended name uses all characters *except* the embedded blank, device control characters, *, ?, ', and " (for example, "PAY (12)" can be used when it is enclosed in quotation marks).

Use meaningful names to make all of your data definitions clear to users not familiar with your data. Use abbreviations for a file definition name when a complete descriptive name cannot fit in 10 characters (8 characters for an extended name).

For your convenience, you might give the file and the file definition the same name. This naming convention lets all users easily associate the file (the data) with the file definition (the description). Creating database files is discussed in "Creating a Database File" on page 8-1.

Note: You may have more than one definition with the same name. Your descriptions of the definitions should help you determine the differences between the definitions.

Record Format Definition Names

A file definition may have one or more record format definitions, although only one is required. Most files contain only one type of record. If you use a single record format definition, you can do one of the following:

- Name a yet-to-be-created record format definition (see "Record Format Definition Name" on page 6-3 for guidelines on naming record formats).
- Let IDDU name your new record format definition when you create it. IDDU adds an R to the file name (for example, if the file name is PAYROLL, the format would be named PAYROLLR).

IDDU does not provide a record format definition name when the file definition name is an extended name.

- Choose a record format definition that already exists in the dictionary.

You might want to define *multiple* record formats for a single file. For example, a sales file might contain one order header record and several transaction records for each order. If one customer placed 10 different orders, for example, there would be 10 order header records for that customer. Information common to each transaction, such as the customer's name and address and the sales representative's name, would be stored in the order header record, while unique information, such as item number and quantity, would be stored in each transaction record.

Before you decide to use a file with multiple record types, however, look carefully at the possible file uses to make sure you can create the necessary output from such

a file. There might be some reports or lists you want to create that require all records in a file to be of the same record type.

Certain kinds of fields *cannot* be used in a file with multiple record formats:

- Date/time/timestamp fields
- Variable-length fields
- Null-capable fields
- DBCS-graphic fields

You should use record ID codes in the record format definitions for files with multiple formats. Otherwise, if no record ID codes are defined, all the records are used for each format in the file. For more information on record ID codes, see “Using Record Identification Codes” on page 10-1. Additionally, a file definition that contains multiple formats can produce only a program-described file when the file is created. “Program-Described Files” on page C-4 discusses considerations when using files with multiple record formats.

Key Field Definition

You can specify up to 120 key fields for a file definition. Key fields are used to arrange the sequence of the records in a file. You can specify ascending or descending sequence for each key field.

You can use key fields only in a single format file definition that does not have record ID codes. Only fields used within the record format may be selected as key fields.

Note: The total size of key fields is limited to 2000 bytes, unless duplicate keys are allowed and arranged in first-changed first-out order (FCFO). For FCFO files, the total size limit for key fields is 1995 bytes.

To determine the total combined length of your key fields, you have to make adjustments if certain kinds of fields are used as key fields:

- For each key field that is null capable, add an extra byte to the total to account for nulls.
- For each key field that is variable length, add two bytes to account for the length value.
- For each key field that is both null capable and variable length, add three bytes to the total to account for nulls and length value.
- For each key field that is DBCS-graphic, double the field length (number of characters) to account for each character being stored as two bytes. If all key fields are DBCS-graphic, the maximum total length is either 1000 characters or 997 characters for a FCFO file.

For more information on selecting key fields, see “Selecting Key Field Sequence” on page 11-1.

Long Comment

You can enter up to 1360 characters of information about the content and purpose of a definition in a long comment.

The long comment could include such information as:

- Source (the name of the department that originated this file)

- Operational information (storage media, backup requirements, start again and recovery procedures, and availability of critical personnel)
- Relationship (description of associations between different file types and between different types of processes)

Text

You can type up to 50 characters of information when creating a file definition to help you identify what the field contains. This description is shown when you view a list of fields.

Creating a File Definition

Creating a file definition consists mainly of selecting from existing record formats or creating a new one.

You need to do the following steps to create a file definition:

1. Choose option 1 (Work with data definitions) from the IDDU menu (or type WRKDTADFN on a command line).
2. On the Select Definition Type display, select option 3 (File) and type the name of the dictionary (or choose it from the list).

```

                                Select Definition Type

Type choices, press ENTER.

Definition type . . . . . -          1=Field
                                       2=Record format
                                       3=File

Data dictionary . . . . . default__ Name, F4 for list

```

3. On the Work with File Definitions display, choose option 1 (Create) and specify the name of the new file definition.

```

                                Work with File Definitions

Dictionary . . . . . : XXXXXXXXXX

Position to . . . . . _____ Starting characters

Type options (and File Definition), press Enter.
 1=Create  2=Change  3=Copy  4=Delete
 6=Print  7=Rename  8=Display where used

      File           File           File           File
Opt Definition     Opt Definition  Opt Definition  Opt Definition
 1 THOMAS_____

```

4. Next you will see the Create File Definition display. If you used the work sheet to plan your file definition, you may want to refer to it as you continue this task.

```

                                Create File Definition
Definition . . . . . : XXXXXXXXXX      Dictionary . . . . . : XXXXXXXXXX

Type choices, press Enter.

Record formats
option . . . . . 2          1=Create and/or select formats
                             2=Create default format
                             and select fields

For choice 2=Create default format:
Format . . . . . default__ Name

Select key field
sequence . . . . . N          Y=Yes, N=No

Long comment . . . . . _      1=Select, 4=Remove

Text . . . . . _____

```

From this display, you can:

- a. Choose whether you want to select your record format(s) from those already in the dictionary (option 1) or to create a *single* new format now (option 2). (If you want to create *multiple* record formats, choose option 1.)
 - b. If you choose to create a single format, name the new record format definition (or accept the default name provided by the system).
 - c. Choose whether to have key fields.
 - d. Choose whether to provide an extended description (long comment) for this file definition.
 - e. Type a brief text description of the file definition.
5. If you chose option 1 (Create and/or select formats), the next display you see will be Create and Select Record Formats, where you can select and sequence the formats to be included in this file definition.

```

                                Create and Select Record Formats
Definition . . . . . : XXXXXXXXXX      Dictionary . . . . . : XXXXXXXXXX

Position to . . . . . _____ Format, sequence (0-99999)

Type sequence numbers (0-99999), (and Format), press Enter.
Type format, press F6 to create.

Seq   Format                Seq   Format                Seq   Format
____  _____           ____  _____           ____  _____
____  XXXXXXXXXXXX         ____  XXXXXXXXXXXX         ____  XXXXXXXXXXXX

```

See “Selecting a Record Format for a File Definition” on page 5-8 for a discussion of this display.

6. If you chose option 2 (Create default format and select fields), the next display you see is Create and Select Field Definitions, where you can choose the field definitions to be included in the new record format and the order in which the fields are to be arranged in the record.

The record format name that you (or IDDU) previously specified on the Create File Definition display appears at the top of this display.

```

                                Create and Select Field Definitions
Definition . . . . . :  fmtnamR           Dictionary . . . . . :  XXXXXXXXXX

Position to . . . . .   _____   Field, sequence (0-99999)

Type sequence numbers (0-99999), (and Field), press Enter.
Type field, press F6 to create.

Seq   Field           End   Seq   Field           End   Seq   Field           End
____  _____

```

See “Selecting a Field Definition” on page 6-6 for a discussion of this display.

- a. If you type the name and sequence of a new field definition in the first position of the list and press F6 (Create field definition), you will see the Create Field Definitions display. Use this to choose the field definitions to include in the new record format and the order the fields are arranged in the record. (See “Planning a Field Definition” on page 7-1 for information on defining fields, and “Selecting a Field Definition” on page 6-6 for information on using the Create and Select Field Definitions display.)
 - b. When you return to the Create and Select Field Definitions display after completing your work with fields, press the Enter key (without making any changes to the display) to tell IDDU that you want the record format definition created.
7. If you entered Y at the *Select key field sequence* prompt, the Select Key Field Sequence display will appear next. This display allows you to choose the order of the key fields.
- When you press the Enter key, the display appears again if you made changes. Press the Enter key to proceed. If you do not change the display, pressing the Enter key allows the program to proceed. See “Selecting Key Field Sequence” on page 11-1 for more information on using the Select Key Field Sequence display.
8. If you chose 1 (Select) for the *Long comment* prompt, the Edit a Long Comment display appears next. There you can type a detailed description of the file definition you are creating.
 9. When you return to the Work with File Definitions display, press F3 (Exit) to return to the IDDU menu or command line.

Creating a Record Format for a File Definition

You can create a file definition with a single (new) record format without using the Create Record Format Definition display. On the Create a File Definition display, choose option 2 (Create default format and select fields), name the new record format definition (or accept the system-supplied name), and press the Enter key.

The system-supplied name for this record format definition is the file name, plus a last character of R, unless the file definition name is 10 characters (in which case the system duplicates the entire name). You can type over this system-supplied name with another as your application requires.

When you press the Enter key, the Create and Select Field Definitions display appears, and the record format definition will be created with the file definition. The tasks on that display are discussed in “Selecting a Field Definition” on page 6-6.

```

                                Create and Select Field Definitions
Definition . . . . . : addressR          Dictionary . . . . . : XXXXXXXXXX

Position to . . . . . _____ Field, sequence (0-99999)

Type sequence numbers (0-99999), (and Field), press Enter.
Type field, press F6 to create.

Seq   Field           End   Seq   Field           End   Seq   Field           End
____  _____      ____  _____      ____  _____      ____
_____ ACCOUNTNUM  XXXXX  _____ XXXXXXXXXXX XXXXX  _____ XXXXXXXXXXX XXXXX

```

Selecting a Record Format for a File Definition

If you chose option 1 (Create and/or select formats) on the Create File Definition display, the Create and Select Record Formats display appears. On this display you can select and sequence one or more existing record format definitions from a list or create new record formats for this file definition. You do this by typing a sequence number in the *Seq* field for the desired formats. Whether you are selecting from existing record format definitions or creating new ones, only definitions with sequence numbers will be selected and used by the file definition.

```

                                Create and Select Record Formats
Definition . . . . . : XXXXXXXXXX          Dictionary . . . . . : XXXXXXXXXX

Position to . . . . . _____ Format, sequence (0-99999)

Type sequence numbers (0-99999), (and Format), press Enter.
Type format, press F6 to create.

Seq   Format           Seq   Format           Seq   Format
  10  _____      _____ XXXXXXXXXXX      _____ XXXXXXXXXXX
  30  ADDRESS          _____ XXXXXXXXXXX      _____ XXXXXXXXXXX
_____ XXXXXXXXXXX      _____ XXXXXXXXXXX      _____ XXXXXXXXXXX
_____ XXXXXXXXXXX      _____ XXXXXXXXXXX      _____ XXXXXXXXXXX
_____ XXXXXXXXXXX      _____ XXXXXXXXXXX      _____ XXXXXXXXXXX
_____ XXXXXXXXXXX      _____ XXXXXXXXXXX      _____ XXXXXXXXXXX
_____ XXXXXXXXXXX      _____ XXXXXXXXXXX      _____ XXXXXXXXXXX
_____ XXXXXXXXXXX      _____ XXXXXXXXXXX      _____ XXXXXXXXXXX
More...

F3=Exit      F5=Refresh      F6=Create record format definition
F11=Display Text  F12=Cancel      F20=Renumber

```

The sequence number of a record format indicates the relative location of the format name within the list of record format definition names. The names of record formats that are not associated with a file definition, but are available from the dictionary, appear without sequence numbers in the lower portion of the list.

Select from existing record format definitions by specifying a sequence number next to the record format definition name in the list. When you specify a sequence number for a format name and press the Enter key, the name is positioned accordingly in the list. The list is repositioned to the sequence number or to the name you specify (in the *Position to* prompt) when you press the Enter key. When you specify a name and no name match is found, the nearest item preceding the name

specified is positioned at the top of the list of format names without sequence numbers. See “Using Lists” on page 3-3.

To change the sequence number of a record format in the list, type the new sequence number next to the record format name and press the Enter key; the name will be moved to the new position.

To remove the name of a format from the list of format definitions used by the file definition, remove the sequence number by spacing over it.

You can create a new record format definition by typing the name of a new record format definition on the top line of the list. Then either accept the sequence number the system assigns to it or type over it with an appropriate new number to properly position the definition in sequence.

After you type the record format name to be created, press F6 (Create record format definition) to go to the Create a Record Format display.

Maintaining File Definitions

Besides creating a file definition, you can also work with definitions in other ways. You can:

- Change a definition
- Copy a definition
- Delete a definition
- Print information about a definition
- Rename a definition
- Display the where-used information about a definition

These maintenance tasks for file definitions are described in Chapter 12, “Maintaining Definitions.”

Chapter 6. Defining Record Formats

Use a record format definition to describe the layout of a data record and define the sequence of fields within a record. When discussing a record format definition, we frequently drop the term definition (as we do for field definition) and refer to it as a *record format*, sometimes even as a *format*.

Planning a Record Format Definition

When you are planning to create (or change) a record format definition, you may find it helpful to use a work sheet to organize the description of the field and then refer to the work sheet as you go through the interactive data definition utility (IDDU) displays.

An example of a record format definition work sheet, including the most commonly used record format definition prompts on the displays, is supplied on the next page. You can copy and use this work sheet, or you may want to create one designed for your own applications.

The descriptions that follow the work sheet will help you in completing it.

Record Format Definition Work Sheet

Data Dictionary Name _____

Record format definition name _____

Field definitions:

Seq	Name	New?	Seq	Name	New?
_____	_____	_____	_____	_____	_____
_____	_____	_____	_____	_____	_____
_____	_____	_____	_____	_____	_____
_____	_____	_____	_____	_____	_____
_____	_____	_____	_____	_____	_____
_____	_____	_____	_____	_____	_____
_____	_____	_____	_____	_____	_____
_____	_____	_____	_____	_____	_____
_____	_____	_____	_____	_____	_____
_____	_____	_____	_____	_____	_____

Long comment (up to 1360 characters)

Text (up to 50 characters of description)

Data Dictionary Name

This is the name of the data dictionary that will contain this format definition (it will be the same as the library containing the dictionary).

Record Format Definition Name

The name of the record format definition you are creating can be up to 10 characters long.

You can begin a record format definition name with any alphabetic character (A through Z) or one of the symbols \$, #, @. You can also use any of those characters and symbols for the remainder of the name, as well as the numbers 0 through 9 and the underscore character (_).

Use a descriptive name for a record format definition. For example, if a definition uses field names related to vacation, you might use a name to indicate this. This helps you identify the definition when you see the name.

Notes:

1. RPG requires that the record format name be different from the name of the file that uses it.
2. You may have more than one record format definition with the same name. Your descriptions of the definitions should help you determine the differences between the definitions.

Field Definitions

When you create record format definitions for a new file, you choose the fields that will be included in the record and the order in which they are positioned. You can choose any definitions in the same dictionary as the record format definition, or you can create new ones.

Consider the following when defining the sequence of fields in a record:

- Displaying

If the main purpose of the file is to display information for viewing (as in a displayed query), you should determine which information the viewer needs when the record is displayed. Although you can specify the order of the fields as they may appear in a report, it might be more convenient for the fields containing the most important information to appear at the beginning of the record.

- Updating

If the file is to be updated frequently, determine which fields will be changed most often. When an operator updates the file, the fields are displayed in the order in which they appear in the record. Define the most frequently updated fields first and place them toward the beginning of the record. This saves the operator time when updating the file.

- Sorting

How records in the file are sorted is also important in determining the order of fields within a record. When viewing or printing records, it might be convenient for the fields used for sorting to appear at the beginning of the record, although you can specify the order of the fields as they may appear in a report. For example, if employee records are to be sorted in ascending order by employee number, place the employee number field at or toward the beginning of the

record. This can provide an easier reference, or better continuity, for the printed or displayed file.

- Entering

The order of the fields as they appear on the source input document is important. For ease of entry, the field order in the file and the field order on the source document should match.

Long Comment

You can enter up to 1360 characters of information about the content and purpose of a definition.

The long comment could include such information as:

- Source (the name of the department that originated this record format)
- Application usage (how the format is used in various applications)
- Report usage (description of the production reports that use this format)
- Forms (any specific forms used to print this format)
- Record ID (description of selection values for this format)

Text

You can type up to 50 characters of information to help you identify what the record contains when creating a record format definition. This description is shown when you view a list of formats.

Record ID Codes

Record ID codes should be specified when multiple record format definitions are used by a file definition for a file.

See Chapter 10, "Record Format Definition Considerations," for more information about record ID codes.

Creating a Record Format Definition

You need to do the following steps to create a record format definition:

1. Choose option 1 (Work with data definitions) from the IDDU menu (or type WRKDTADFN on a command line).
2. On the Select Definition Type display, select option 2 (Record format), and type the name of the dictionary (or choose it from the list).

```
                                Select Definition Type
Type choices, press Enter.
Definition type . . . . . _          1=Field
                                       2=Record format
                                       3=File
Data dictionary . . . . . _____ Name, F4 for list
```

3. On the Work with Record Format Definitions display, choose option 1 (Create), and specify the name of the new record format definition.

```

Work with Record Format Definitions
Dictionary . . . . . : XXXXXXXXXX
Position to . . . . . _____ Starting character(s)
Type options (and Record Format Definition), press Enter.
  1=Create  2=Change  3=Copy  4=Delete
  6=Print  7=Rename  8=Display where used
Opt  Format      Opt  Format      Opt  Format      Opt  Format
  -  _____  -  _____  -  _____  -  _____

```

4. Now the Create Record Format Definition display appears. If you used the work sheet to plan your record format definition, you may want to refer to it as you continue this task.

```

Create Record Format Definition
Definition . . . . . : XXXXXXXXXX Dictionary . . . . . : XXXXXXXXXX
Type choices, press Enter.
Create and select
  field definitions . . Y      Y=Yes, N=No
Specify
  record ID codes . . . N     Y=Yes, N=No
Long comment . . . . . _     1=Select, 4=Remove
Text . . . . . _____

```

On this display:

- a. Indicate that you will create new field definitions for this format and/or select from the definitions that exist in the dictionary. (Because this is a Create task, you cannot change the first item.)
 - b. Choose whether to identify record ID codes for this format (required if multiple formats exist in the file definition).
 - c. Choose whether to provide an extended description (long comment) for this definition.
 - d. Type a brief text description for this definition.
5. Next the Create and Select Field Definitions display appears, where you can choose the field definitions to include in the new record format and the order the fields are arranged in the record. See “Selecting a Field Definition” on page 6-6 for information on using this display.

```

                                Create and Select Field Definitions
Definition . . . . . :  FMTNAMR           Dictionary . . . . . :  XXXXXXXXXXXX

Position to . . . . .   _____   Field, sequence (0-99999)

Type sequence numbers (0-99999), (and Field), press Enter.
Type field, press F6 to create.

Seq   Field           End   Seq   Field           End   Seq   Field           End
____  XXXXXXXXXXXX   XXXXX  ____  XXXXXXXXXXXX   XXXXX  ____  XXXXXXXXXXXX   XXXXX

```

- a. If you type the sequence and name of a new field definition in the first position of the list and press F6 (Create field definitions), the Create Field Definitions display appears. (See "Planning a Field Definition" on page 7-1 for information on defining fields.) Pressing the Enter key without changing the display causes the Create and Select Field Definitions display to appear again.
 - b. When you return to the Create and Select Field Definitions display after completing your work with fields, press the Enter key (without making any changes to the display) to tell IDDU that you are ready for the next step.
6. If you chose Y for the *Specify record ID codes* prompt, the Define Record ID Codes display appears next. See "Using Record Identification Codes" on page 10-1 for information on using this display.
 7. If you chose 1 (Select) for the *Long comment* prompt, the Edit a Long Comment display appears next. There you can type a detailed description of this record format definition. Pressing the Enter key as you complete the Long Comment will bring you to the Work with Record Format Definitions display.
 8. When you return to the Work with Record Format Definitions display, press F3 (Exit) to return to the IDDU menu or command line.

Selecting a Field Definition

Whether you select from existing field definitions or create new ones, only field definitions with sequence numbers are used by the record format definition. Use the Create and Select Field Definitions display to select and sequence one or more existing definitions from a list or create new field definitions. You do this by typing a sequence number in the *Seq* field for the desired fields.

```

                                Create And Select Field Definitions
Definition . . . . . :  FMTNAMR           Dictionary . . . . . :  XXXXXXXXXXXX

Position to . . . . .   _____   Field, sequence (0-99999)

Type sequence numbers (0-99999), Field, and press Enter.
Type field, press F6 to create.

Seq   Field           End   Seq   Field           End   Seq   Field           End
____  XXXXXXXXXXXX   XXXXX  ____  XXXXXXXXXXXX   XXXXX  ____  XXXXXXXXXXXX   XXXXX
____  XXXXXXXXXXXX   XXXXX  ____  XXXXXXXXXXXX   XXXXX  ____  XXXXXXXXXXXX   XXXXX
____  XXXXXXXXXXXX   XXXXX  ____  XXXXXXXXXXXX   XXXXX  ____  XXXXXXXXXXXX   XXXXX

```

The sequence number describes the position of a field definition in the record format. When you specify a sequence number to a field definition, that number will be assigned to the definition, and it will be positioned accordingly in the list.

You can use F11 (Display text) to see the field type of each field (for example, character, variable-length character, date, packed, zoned, binary, or floating point). Field definitions with sequence numbers have already been selected to be used by the format definition named on the display, and will be used in the ascending order of those sequence numbers as they appear in the upper portion of the list. The value shown in the *End* column can be used to determine the length of the field definition. By using F11 (Display text), you can use the date and text columns to determine which of any identically named fields you want to use, because each field must have a unique name (and alias) within the record format.

Do not let the total of field sizes used by a single record format definition exceed 32 766 bytes. If you exceed that size, IDDU will not let you save the definition.

The field definitions in this dictionary that are not selected for this format, but are available to be used, appear without sequence numbers in the lower portion of the list.

To create new field definitions, type each new definition name on the top line of the list. The system will assign a sequence number which you can accept, or you can type over it with an appropriate number. If you do not specify a sequence number for the new definition, the new name will be placed in alphabetical order in the lower portion of the list with the other names without sequence numbers.

After you type the name of a field definition to be created, press F6 (Create field definition) to go to the Create Field Definitions display, which is discussed in “Creating a Field Definition” on page 7-12.

Maintaining Record Format Definitions

Besides creating a record format definition, you can also work with definitions in other ways. You can:

- Change a definition
- Copy a definition
- Delete a definition
- Print information about a definition
- Rename a definition
- Display the where-used information about a definition

These record format definition maintenance tasks are described in Chapter 12, “Maintaining Definitions.”

Chapter 7. Defining Fields

Use a field definition to tell the system certain characteristics about the data. For example, does the field contain characters or numbers, and how big is the field? When discussing a field definition, we frequently drop the term definition (as we do for record format) and refer to it as a *field*.

You need a different field definition for each unique field in the files. However, when you have a data dictionary, a field that appears in many files with the same characteristics in each file needs only one field definition. For example, a field created to handle names could be used throughout all your applications.

Planning a Field Definition

When you are planning to create (or change) a field definition, you may find it helpful to use a work sheet to organize the description of the field. An example of a field definition work sheet, including the most commonly used field definition prompts on the IDDU displays, follows. You can copy and use this work sheet, or you may want to create one designed for your own applications.

The descriptions that follow the work sheet will help you in completing it.

Field Definition Work Sheet

You must define the following information for all field types:

Data Dictionary Name _____	
Field definition name	_____ (up to 10 characters)
Type	_____ (Character, Numeric, DBCS, or Date/Time)
Size	_____ (up to 32766 for Character or Bracketed DBCS fields; 16383 for DBCS-Graphic; 31 for Numeric; blank for Date/Time)
Decimal positions	_____ (0-31 for Numeric, otherwise blank)
Text	_____ (up to 45 characters of description creating, 50 when changing)

More options?	_____ (yes or no – see following sections of work sheet for possible choices)

More options allows this information for all field types:

Null attribute.	_____ (Null, Not Null, Not Null with Default)
Column headings	
Heading 1	_____ (up to 20 characters per heading)
Heading 2	_____
Heading 3	_____
Alias.	_____ (up to 30 characters)
Long comment	(up to 1360 characters)

More options allows this information for numeric field types:

Numeric data type _____	(zoned, packed, binary, or floating point)
Numeric editing mode _____	(Numeric field, Date/Time, Edit Code, or Edit Word)
Numeric field editing choices:	
Decimal point _____	(. , : \$ or none)
Thousands separator _____	(. , ' blank or none)
Use sign for negative number? . . _____	(yes or no)
If yes, place where? _____	(right or left)
Use currency symbol? _____	(yes or no)
If yes, place where? _____	(right or left)
Print zero value? _____	(yes or no)
Replace leading zeros? _____	(yes or no)
If yes, with what? _____	(blanks, asterisks, or floating currency symbol)
Show single leading zero? . . _____	(yes or no)
Date or time separator _____	(. / : - or ,)

More options allows this information for character (SBCS) field types:

Data type _____	(character (SBCS), hexadecimal)
Variable length _____	(yes or no)
Allocated length _____	(up to 32740 characters for non-null fields, up to 32739 characters for null fields)
Coded Character Set	
Identifier (CCSID) _____	(up to 65535)

More options allows this information for DBCS field types:

DBCS data type	_____	(open, only, either, graphic)
Variable length	_____	(yes or no)
Allocated length	_____	(up to 32740 characters for non-null bracketed DBCS fields or 16370 for non-null graphic DBCS fields; one character less for null fields)
Coded Character Set		
Identifier (CCSID)	_____	(up to 65535)

More options allows this information for Date/Time field types:

Data type	_____	(Date, Time, Timestamp)
For date fields		
Date format	_____	(*USA, *ISO, EUR, *JIS, *MDY, *DMY, *YMD, *JUL)
Date separator	_____	(slash, period, comma, dash, or blank if format is not *USA, *ISO, *EUR, *JIS)
For time fields		
Time format	_____	(*USA, *ISO, *EUR, *JIS, *HMS)
Date separator	_____	(colon, period, comma, or blank if format is not *USA, *ISO, *EUR, *JIS)
For timestamp: format and separator already specified		

Notes:

Basic Characteristics of All Field Definitions

The following characteristics are common to all field definitions.

Data Dictionary Name

This is the name of the data dictionary that will contain this field definition (it will be the same as the library containing the dictionary).

Field Name

The name of the field definition you are creating can be up to 10 characters.

You can begin a field definition name with any alphabetic character (A through Z) or one of the symbols \$, #, @. You can also use any of those characters and symbols for the remainder of the name, as well as the numbers 0 through 9 and the underscore character (_).

Use meaningful names to make all of your data definitions clear to users not familiar with your data. Use abbreviations for a field name when a complete descriptive name cannot fit in 10 characters. You should use the same field name across all data dictionaries. For example, if you use LASTNAME for all the field names that refer to the last name, this helps you identify the field definition when you see it regardless of what dictionary you are in.

If a field is used in many files and has the same characteristics in each file, you should reuse the same field definition in each file definition.

Note: You may have more than one field definition with the same name. Your description of the definitions should help you determine the differences between the definitions.

Field Type

The field type definition specifies whether the data in the field is character (single-byte character set (SBCS) characters or numbers), numeric, double-byte character set (DBCS characters or numbers), or date/time. (You can further define these data types by choosing *More options*.)

Field Size

The field size is the length of the field, specified as follows:

- For the default numeric data type, packed (decimal), field size is the number of digits. The maximum size is 31. See "Additional Characteristics for Numeric Fields" on page 7-8 for maximum field sizes of other numeric data types.
- For character (SBCS) data type, field size is the number of characters. The maximum size is 32 766 (32 740 for a variable-length character field).
- For bracketed-DBCS data types (if your system supports DBCS), field size is twice the number of double-byte characters plus two, which allows for the shift-out and shift-in (bracket) characters. The maximum size is 32 766 (32 740 for a variable-length DBCS field).
- For DBCS-graphic data type, field size is specified as the number of double-byte characters. The maximum size you can specify is 16 383 characters (16 370 characters for a variable-length graphic field). The actual storage space required for the field is twice the number of characters.

- Date/time field size cannot be specified because it is automatically determined by the date/time data type.

The total space required for all fields in a single record format definition cannot exceed 32 766 bytes.

Each field should be long enough to contain the largest number of characters or digits for that field in any record. For example, the length of each customer's name varies, but 20 positions might be long enough to contain most customer names. For another example, if you have a field that will contain the name of a state, do not make the field long enough for Massachusetts when you are only going to enter MA. You cannot easily make a field shorter after it is linked to a disk file.

How you plan to use the data in the field should determine the length of your data field. For example, you might break a very long field into smaller fields to be sure you can fit the information from the file in your report or document.

Decimal Positions

Use the *decimal positions* field when you are defining a numeric field. The system allows up to 31 positions, but in all cases, the number of decimal positions cannot exceed the field size.

In the case of floating-point numbers, the number of positions is the number of significant digits.

Text

You can type up to 45 characters of information when creating a field definition (up to 50 when changing). This description is shown when you view a list of fields and helps you identify what the fields contain.

More Options

To define additional information about your field, specify yes for the *More options* prompt. The topics on "Additional Characteristics for All Field Types" and "Additional Characteristics for Numeric Fields" on page 7-8 discuss this information.

Additional Characteristics for All Field Types

You can further define the data as to required control of keyboard entry, description, labeling, and detailed numeric characteristics by choosing *More options* when creating or changing a field definition.

Column Headings

You can specify three column headings, each up to 20 characters long, that describe the data in the field. These headings are used in reports produced by applications using the field. If you do not specify a column heading, the office applications of the AS/400 system use the field name as the first column heading.

You can change the column headings in the report or document using Query/400 or OfficeVision; the column headings in the field definition, however, remain unchanged.

Null Attribute

If you do not add data to a file, you can specify how space for the data appears. The values allowed for the null attribute are:

- **Null** means that the field has no value.
- **Not null** means that a value must be entered at data entry time.
- **Not null with default** means that a default value will be provided.

The default null attribute is *not null with default*. For IDDU, the default values are blank for character and DBCS values, 0 for numeric values, and the following for date/time values:

Date 1 January 1940

Time 0 hours 0 minutes 0 seconds

Timestamp 1 January 1940 0 hours 0 minutes 0 seconds

Long Comment

You can enter up to 1360 characters of detailed information about the content and purpose of a definition.

The long comment could include such information as:

- Source (the name of the organization that generated the particular field)
- Data structure (the rules and structure that the data must adhere to)
- Value and description (the valid range of values and codes as well as a description of the values for a specific field)
- Glossary (an explanation of the terms/fields peculiar to the industry in which your business happens to be)
- Source of input (an explanation of which sources generate the data for the field)

Keyboard Shift

You can control what type of (and whether) data can be entered in each field. Keyboard shift is used when a program uses a display file that refers to fields in the database file currently being defined. However, the data file utility (DFU) does not use keyboard shift. See “Part 3. Maintaining Data, Definitions, and Dictionaries” for information on keyboard shift.

Note: Keyboard shift does not support DBCS fields, but does support character and numeric fields.

Alias (Alternative Name)

Some high-level programming languages use an alias as an alternative name for the field described by a definition. However, the alias is not used by any of the office applications of the AS/400 system. See “Part 3. Maintaining Data, Definitions, and Dictionaries” for information on aliases.

Additional Characteristics for Numeric Fields

For numeric fields, there are also characteristics such as the type of numeric data and any other editing unique to a numeric field. This additional editing can be for a number, date, or time value. You can also specify the time and date separator, the thousands symbol, and the symbol and location for negative values, currency, and leading zeros.

Numeric Data Type

For a numeric field, you can accept packed (decimal) as the data type, or you can specify one of the following data types to describe the way the data is stored:

- **Zoned** means this field can contain zoned decimal data, with a maximum field length of 31 positions, any or all of which can be decimal.
- **Packed** (the default data type) means this field can contain packed decimal data, with a maximum field length of 31 positions, any or all of which can be decimal.
- **Binary** means this field contains binary data, with a maximum field length of 9 positions, any or all of which can be decimal.
- **Floating point** means this field contains floating point data, with a maximum field length for single (short) precision of 9 positions, and for double (long) precision of 17 positions, any or all of which can be decimal.

DFU supports only binary, zoned decimal, and packed decimal data types for numeric fields. IDDU field definitions for fields used by the data file utility must adhere to this restriction.

Numeric Editing Choices

You can specify these different numeric editing characteristics:

- Field editing, including separators, symbols, and treatment of zeros
- Date or time value separators
- An edit code, which is a single character representing a set of editing characteristics
- An edit word, which is a string of characters that control the final appearance of the edited field

Field editing and date/time editing are described in the following paragraphs; edit codes and edit words, because they are infrequently used with Office and Query applications, are discussed in Chapter 9, "Field Editing Techniques." A system-wide view of edit codes and edit words is presented in the *DDS Reference*.

Numeric Field Editing: You can specify any of the following:

- **Decimal point** can be period (.), comma (,), colon (:), currency (\$), or none.
- **Thousands separator** can be period (.), comma (,), apostrophe ('), blank, or none.
- **Negative sign**
 - Choose whether to show a negative symbol.
 - Specify up to six valid system characters for a symbol.
 - Choose a location relative to the value; left, right, or both.
- **Currency symbol**

- Choose whether to show a currency symbol.
- Specify up to six valid system characters for a symbol.
- Choose a location relative to the value; left, right, or both.
- **Print a zero value** specifies whether zero values are to be printed.
- **Replace leading zeros** specifies whether the leading zeros of a value are to be replaced. If so, you can choose to replace them with blanks, asterisks, a single floating currency symbol, or a single leading zero.
- **Show single leading zero** specifies whether a single leading zero should be printed.

Date/Time Editing: The separator can be a period (.), slash (/), colon (:), hyphen (-), or comma (,).

Additional Characteristics for Character and DBCS Fields

Character (SBCS) and DBCS fields have additional options that allow you to define a field as variable length and then define the allocated data length. You can also specify character set identifiers for systems with either the same or different languages than your own.

Character (SBCS) Data Type

For a character (SBCS) field, you can accept character as the data type, or you can specify hexadecimal data type:

- **Character** (the default data type) means this field can contain any of the characters in the single-byte character set.
- **Hexadecimal** means this field can contain only hexadecimal data, consisting of the characters 0 through 9 and A through F.

DBCS Data Types

For a DBCS field, you can specify one of the bracketed-DBCS data types or DBCS-graphic data type:

- **DBCS-open** means this field can contain a mixture of SBCS and bracketed-DBCS data.
- **DBCS-only** means this field can contain only bracketed-DBCS data.
- **DBCS-either** means this field can contain either SBCS data or bracketed-DBCS data, but not both types.
- **Graphic** means this field can contain DBCS-graphic data.

Variable Length

You can specify whether a field is to be variable length. The values allowed in this field are Y=Yes and N=No. The default value for this field is No. If you specify a length, it is assumed to be the maximum length of the variable-length field (including the two bytes for the shift-out and shift-in (bracket) characters, if it is a bracketed-DBCS field). You cannot specify a value greater than 32 740 (16 370 for a DBCS-graphic field).

Allocated Length

If you specify a variable-length field, you can also specify the allocated length, which is the estimated length that the field will be most of the time. This reduces the amount of space used to store the field in the database. For example, you can define a variable-length character field as 100 characters with an allocated length of 30 characters. This means the majority of the data will be 30 characters long but some could be as long as 100 characters.

The allocated length must be less than or equal to the field length. If the field is a null-capable character field, then the maximum allowable allocated length is 32739. Otherwise, the maximum allowable allocated length is 32740.

Coded Character Set Identifier (CCSID)

You can specify the coded character set identifier (CCSID) you want to use. The CCSID enables conversion of data from one coded character set to another. The valid values range from 1 to 65535. The system uses the default value if the CCSID is not specified when the file is created. If you specified the field to be a hexadecimal field, the field is automatically tagged with CCSID 65535.

Example of conversion:

- A field is tagged with a CCSID of 227 (Danish).
- Your job CCSID is 037 and you are working on an English (037 code page) keyboard.
- You enter the character \$ (hex value 5B) as input into the field. Database converts the hex value 5B into the CCSID 227 hex value 67 (character \$) to preserve the dollar sign.

For additional information about CCSIDs, see *National Language Support*, SC41-5101.

Additional Characteristics for Date/Time/Timestamp Fields

For Date, Time, and Timestamp fields, there are characteristics for defining formats and separators. Format and separators can only be changed for date and time fields. Timestamp fields have fixed formats with separators that look like YYYY-MM-DD-hh.mm.ss.uuuuuu and have a fixed length of 26 characters.

Date Format

Use the *Date Format* field to specify how you want your date to appear. Use one of the predefined standard formats listed in Figure 7-1, or define your own format.

Figure 7-1. Date Format Options

Country Standard	Format	Fixed Length
*USA (IBM USA Standard)	mm/dd/yyyy	10
*ISO (International Standards Organization)	yyyy-mm-dd	10
*EUR (IBM European Standard)	dd.mm.yyyy	10
*JIS (Japanese Industrial Standard Christian Era)	yyyy-mm-dd	10
*MDY (Month/Day/Year)	mm/dd/yy	08
*DMY (Day/Month/Year)	dd/mm/yy	08
*YMD (Year/Month/Day)	yy/mm/dd	08
*JUL (Julian)	yy/ddd	06

Date Separator

If you specified *MDY, *DMY, *YMD, or *JUL date format, you can specify a date separator. The date separators for the *USA, *ISO, *EUR, and *JIS values are predetermined and cannot be changed. The following values are valid date separators:

- slash (/)
- period (.)
- comma (,)
- dash (-)
- blank ()

Time Format

Use the *Time Format* field to specify how you want your time to appear. Use one of the predefined standard formats listed in Figure 7-2, or define your own format.

Figure 7-2. Time Format Options

Country Standard	Format	Fixed Length
*USA (IBM USA Standard)	hh:mm AM hh:mm PM	08
*ISO (International Standards Organization)	hh.mm.ss	08
*EUR (IBM European Standard)	hh.mm.ss	08
*JIS (Japanese Industrial Standard Christian Era)	hh:mm:ss	08
*HMS (Hours/Minutes/Seconds)	hh:mm:ss	08

Time Separator

If you specified *HMS as the time format, you can specify a time separator. The time separators for the *USA, *ISO, *EUR, and *JIS values are predetermined and cannot be changed. The following values are valid time separators:

- colon (:)
- period (.)
- comma (,)
- blank ()

Creating a Field Definition

You need to do the following steps to create a field definition:

1. Choose option 1 (Work with data definitions) from the IDDU menu (or type WRKDTADFN on a command line).
2. On the Select Definition Type display, select option 1 (Field) and type the name of the dictionary (or choose it from the list).

```

                                Select Definition Type

Type choices, press Enter.

Definition type . . . . . -          1=Field
                                       2=Record format
                                       3=File

Data dictionary . . . . . default__ Name, F4 for list
  
```

3. On the Work with Field Definitions display, choose option 1 (Create) and specify the name of the new field definition.

```

                                Work with Field Definitions

Dictionary . . . . . : XXXXXXXXX

Position to . . . . . _____ Starting characters

Type options (and Field Definition), press Enter.
1=Create 2=Change 3=Copy 4=Delete
6=Print 7=Rename 8=Display where used

   Field          Field          Field          Field
Opt Definition   Opt Definition   Opt Definition   Opt Definition
-  _____   -  _____   -  _____   -  _____
  
```

4. Now you see the Create Field Definitions display. If you used the work sheet to plan your field definition, you may want to refer to it as you continue this task.

```

                                Create Field Definitions

Type information, press Enter to create.
Field type (size) . . : 1=Character (1-32766)
                       2=Numeric (1-31, decimal positions 0-31)
                       3=DBCS (4-32766, mixed; 1-16383, graphic)
                       4=Date/Time (no size)
More options . . . . . : Y=Yes

-----Field----- Dec More
Name      Type Size  Pos Opt  Text
-----
_____ -  _____ -  -  _____
_____ -  _____ -  -  _____
_____ -  _____ -  -  _____
  
```

From this display you can specify any additional descriptive information needed, such as the field's type, size, or text. For numeric fields, you have to specify the number of decimal positions. When necessary, indicate more options are required.

5. If you specified Yes for the *More options* prompt, you next see the Character Field Options display, the Numeric Field Options display, the DBCS Field Options display, or the Date/Time Field Options display. The following display is a generic example of the options available on these displays.

```

... Field Options
Definition . . . . . : XXXXXXXXXX      Dictionary . . . . . : XXXXXXXXXX
Type choices, press Enter.
... data type                _____
Column headings:
Heading 1 . . . . . : _____
Heading 2 . . . . . : _____
Heading 3 . . . . . : _____

```

You can specify detailed data type, column headings, long comment, and an alias for all fields. For numeric fields, you can choose numeric editing and keyboard shift. For character fields, you can choose keyboard shift.

6. If you chose numeric field editing, you see the Describe Numeric Field Editing display, on which you can choose the specific kind of editing you want to do.

```

Describe Numeric Field Editing
Definition . . . . . : XXXXXXXXXX      Dictionary . . . . . : XXXXXXXXXX
Type choices, press Enter.
Decimal separator . . . . . - 1=. 2=, 3=: 4=$ 5=None
Thousand separator . . . . . - 1=. 2=, 3=' 4=Blank 5=None
Show negative sign . . . . . - Y=Yes N=No
Left negative sign . . . . . _____
Right negative sign . . . . . _____
Show currency symbol . . . . . - Y=Yes N=No
Left currency symbol . . . . . _____
Right currency symbol . . . . . _____
Print zero value . . . . . - Y=Yes N=No
Replace leading zeros . . . . . - Y=Yes N=No
Replace with . . . . . - 1=Blanks
                          2=Asterisks
                          3=Floating currency symbol
Single leading zero . . . . . - Y=Yes N=No
F3=Exit F12=Previous

```

Depending on the edit mode you choose, you will get another display on which to specify your requirements.

7. If you chose 1 (Select) for the *Long comment* prompt, the Edit a Long Comment display appears next. There you can type as detailed a description of this file definition as necessary.
8. Pressing the Enter key returns you to the Create Field Definitions display after defining the field. Press the Enter key again (without making any changes to the display) to tell IDDU that you are ready for the next step. (You could now specify additional fields to create.)
9. Pressing the Enter key returns you to the Work with Field Definitions display, and pressing F3 (Exit) returns you to the IDDU menu or command line.

Maintaining Field Definitions

Besides creating a field definition, you can also work with definitions in other ways. You can:

- Change a definition
- Copy a definition
- Delete a definition
- Print information about a definition
- Rename a definition
- Display the where-used information about a definition

These field definition maintenance tasks are described in Chapter 12, “Maintaining Definitions.”

Chapter 8. Working with Database Files

When the appropriate definitions have been created and exist in the dictionary, you can use the interactive data definition utility (IDDU) to create database files and go to the data file utility (DFU) to enter data into those files.

You use the Work with Database Files display to name the database files you want to work with and to describe the kind of work you want to do. After you have created the definitions that describe a file and placed them in a dictionary, you can choose either to create a database file or to enter data into an existing file (using DFU).

Creating a Database File

After you have completed creating the necessary file definitions, you can create the database file using the Work with Database Files display. You can get to this display either from the main IDDU menu, or by entering the WRKDBFIDD command.

Create as many files as you require by entering a new file name each time you return to the display. These file names might have a level of authority previously assigned to them (authority holder). This will affect the authority you can assign.

You need to do the following to create a database file:

1. Choose option 3 (Work with database files) from the IDDU menu (or type WRKDBFIDD on a command line).
2. On the Work with Database Files display, choose option 1 (Create), name the new file, and if necessary, specify the library that will contain the file.

```
Work with Database Files
Library . . . . . default__ Name, F4 for list
Position to . . . . . _____ Starting characters

Type options (and Database file), press Enter.
  1=Create  2=Enter data

      Database      Database      Database      Database
Opt  File          Opt  File          Opt  File          Opt  File
-  _____
```

3. You see the Create a Database File display next, showing the name of the new file and its library.

```

                                Create Data Base File
File . . . : XXXXXXXXX          Library . . . : XXXXXXXXX
Type choices, press Enter.
Related definition information:
File definition . . . . . _____ Name, F4 for list
Dictionary . . . . . default__ Name, F4 for list
Authority . . . . . *LIBCRTAUT *LIBCRTAUT, *ALL, *CHANGE
                                *USE, *EXCLUDE
                                Authorization list name

F3=Exit  F4=List  F6=Create file definition  F12=Previous

```

On this display, specify the name of the file definition and the dictionary, and also choose the authority others have to this file. Press F6 (Create file definition) to create a file definition for the file.

4. When the system creates the file, it is automatically linked to its file definition. This linking of files and file definitions is discussed in “Linking and Unlinking Files and Definitions” on page 14-1.

Securing a Database File

For security reasons, you should control the access that other users have to your database file.

When a file is created using dictionary definitions, many people can use the file, even though they might not be authorized to use the dictionary. However, they must be authorized to a data dictionary before they can change the definitions in that dictionary.

The *Authority* prompt on the Create a Database File display allows you to specify how much control other users have over the contents of the file.

Levels of Authority

You can grant the following access, or levels of authority, to other users when you create a database file:

***LIBCRTAUT**

A user can be allowed or denied the authority to use the file created using the Create Authority (CRTAUT) value in the library in which the file is being created.

***ALL**

All users can work with the data in this file and can change others' authority to the file data.

***CHANGE**

All users can work with the data in this file, including changing it, but cannot change authority to the file.

***USE**

All users can copy and print data from this file, but they cannot alter the contents of the file. This is called **read authority**.

***EXCLUDE**

No other user has any access to this file.

Authorization Lists

If different users have different levels of authority, you can specify the name of a user-created authorization list containing the names of specific users to be authorized to this file and the authority level for each individual. The authorization list must already exist on the system before you create the file.

For more information about authorization lists, see *Security – Reference and Managing OfficeVision/400*.

Entering Data into a Database File

You use DFU to work with the data files described by an IDDU-created file definition. DFU lets you:

- Add records to a file
- Change records in a file
- Delete records from a file

After the file has been created, you can enter data into it by choosing option 2 (Enter data) on the Work with Database Files display and specifying the name of the appropriate file definition.

DFU will read the file definition name and create a temporary data entry program that allows you to enter, change, and delete records in the associated file. DFU uses all the formats and fields you have defined in your file definition. The temporary program will disappear when you are finished with the data entry.

See the *ADTS/400: Data File Utility* book for detailed information on using DFU.

Part 3. Maintaining Data, Definitions, and Dictionaries

This part describes the tasks related to maintaining data dictionaries, and file, record format, and field definitions.

These tasks include copying, changing, printing, deleting, and showing where definitions are used. Some experience with IDDU is assumed and, in some cases, an understanding of programming relationships.

Chapter 9. Field Editing Techniques

This chapter provides information on performing more complicated field editing functions using the interactive data definition utility (IDDU). These functions require an understanding of one or more of the following:

- Programming techniques
- Display field input requirements
- Multiple record formats
- High-level language requirements

Edit Codes

Edit codes are letters or numbers indicating that a defined pattern of editing should take place in a field before the field is displayed or printed. Edit codes allow a user to define how data will be presented on a printer or display. For further information on edit codes see the *DDS Reference* book.

Specify either an OS/400 edit code or a user-defined edit code to control the printing of output-capable numeric fields as follows:

- Suppress leading zeros.
- Punctuate a field with commas and periods to show the decimal column and to group digits by threes.
- Print negative values with a minus sign or CR to the right of the value.
- Print zero values as zeros or spaces.
- Print asterisks to the left of significant digits to provide protection.
- Print the currency symbol defined for your system (QCURSYM) immediately to the left of the leftmost significant digit (called a **floating-currency symbol**). For fixed-currency symbols, use an edit word instead of an edit code.
- Edit the field as defined in a user-defined edit code.

```
                                Specify Edit Code
Definition . . . . . : XXXXXXXXX      Dictionary . . . . . : XXXXXXXXX
Type choices, press Enter.
Edit code . . . . . _ 1-4, A-D, J-Q, X-Z, user defined 5-9
Optional edit code
modifier . . . . . - 1=Asterisk fill
                   2=Floating currency symbol
```

You cannot specify an edit code and an edit word for the same field.

Edit Code Table

The OS/400 edit codes are the characters 1 through 4, A through D, J through Q, and X through Z.

Use an edit code of X to suppress the leftmost zero of a 3- to 6-digit date field, and the two leftmost zeros of a 7-digit date field. The Y edit code additionally inserts slashes (/) between the month, day, and year. The Z edit code removes any plus or minus sign from a numeric field and changes the sign of the units column to a hexadecimal F.

Note: Edit code X does not affect printer files. AS/400 hardware operates with a preferred sign of F, which is equivalent to using edit code X.

The common values among all of these edit codes are:

- Left negative symbol = N through Q
- Left currency symbol = symbol defined for your system (QCURSYM)
- Right currency symbol = none
- Replace leading zeros = yes

Edit Code	Thousands Separator	Print Negative Value	Right Negative Symbol	Print Zero Value
1	See below	N		Y
2	See below	N		N
3	None	N		Y
4	None	N		N
A	See below	Y	CR	Y
B	See below	Y	CR	N
C	None	Y	CR	Y
D	None	Y	CR	N
J	See below	Y	-	Y
K	See below	Y	-	N
L	None	Y	-	Y
M	None	Y	-	N
N	See below	Y	-	Y
O	See below	Y	-	N
P	None	Y	-	Y
Q	None	Y	-	N

The symbols for decimal point and thousands separator (when indicated above), and the showing of a single leading zero (to the left of the decimal point), are all dependent on the system value for the decimal format (QDECFMT).

Decimal Format Value	Decimal Point	Thousands Separator	Show Single Zero
Blank	.	,	N
I	,	.	N
J	,	.	Y

The printed currency symbol and the character that replaces leading zeros depend on the edit code modifier selected.

Modifier Value	Print Currency	Replace Zeros With:
Blank	N	blanks
Asterisk	N	*
Currency	Y	Floating currency

You can optionally specify either asterisk fill or a floating currency symbol with edit codes 1 through 4, A through D, and J through Q. For asterisk fill, an asterisk (*) is written for each zero suppressed, and a complete field of asterisks is printed for a zero-balance field.

The floating-currency symbol appears to the left of the leftmost significant digit. It does not print on a zero balance when an edit code is used that suppresses the zero balance. The symbol you specify must match the system value for the currency symbol (QCURSYM). (The symbol must match when the file is created. It does not have to match when the file is used.)

Note: If an edit code is changed after a file is created, the new edit code is not used unless the file is re-created. Instead, the editing specified at the time the file was created continues to be used.

Edit Word

You can specify the free-format editing of numeric fields on the AS/400 system using the Specify Edit Word display.

Specify Edit Word

```

Definition . . . . . : XXXXXXXXXXXX      Dictionary . . . . . : XXXXXXXXXXXX
Length . . . . . : XXXXX
Heading 1 . . . . . : XXXXXXXXXXXXXXXXXXXX
Heading 2 . . . . . : XXXXXXXXXXXXXXXXXXXX
Heading 3 . . . . . : XXXXXXXXXXXXXXXXXXXX

Type edit word, press Enter. (Enclose edit word in apostrophes. Each blank is
replaced by a digit, each ampersand (&) by a blank.)

Edit word . . . . . _____
_____
_____

F3=Exit  F12=Previous

```

An edit word specifies the form in which the field values are to be displayed and inserts characters directly. The edit word can also be used to suppress leading zeros and provide asterisk fill protection for a field.

An edit word used to format a field can be up to 246 characters. The edit word must be enclosed in apostrophes ('), and any embedded apostrophes must be typed twice ("). You cannot specify both an edit code and an edit word for the

same field. A complete discussion of the definition of edit words is in the *DDS Reference*.

Alias (Alternative Name)

The alias is used by some high-level programming languages as an alternative name for the field described by a definition. The alias is not used by any of the office applications of the AS/400 system. A common practice is to make the alias the same as the name given to this field by the program that uses a file.

When used, an alias must be unique in the record format definition, with no other field definition used by the same record format having either the same alias or the same name. That is, any field's name must not be the same as some other field's alias. It can be no longer than 30 characters. An alias must begin with an alphabetic character followed by alphanumeric characters A through Z, 0 through 9, or underscore; however, an underscore cannot be used as the last character.

Do not make an alias the same as any other alias, or the same as any field definition name that will be used by the same record format definition. When renaming a field definition, you cannot use a new name that is the same as a field name or an alias within the same record format definition.

Keyboard Shift and Data Type

A display file determines the characteristics of the data entered and shown on a display. You cannot define a display file with IDDU, but a display file can refer to the files created using IDDU definitions. These definitions would determine the field characteristics, one of which is keyboard shift.

To specify which type of shift the keyboard should be placed in for the operator, or what DBCS data type will be accepted when the file is being used, choose 1 (Select) for the *Keyboard shift for display file reference* prompt on the character or numeric field options displays. The DBCS data type is chosen directly on the DBCS Field Options display. Remember that DFU does not recognize keyboard shift.

Note: If Hexadecimal data type is chosen, the keyboard shift cannot be specified.

Character Keyboard Shift

To choose the keyboard shift for a character field, specify 1 (Select) for the *Keyboard shift for display file reference* prompt on the Character Field Options display.

```

                                Character Field Options
Definition . . . . . : FIELDNAME          Dictionary . . . . . : MYDICT
Type choices, press Enter.

Hexadecimal
data type . . . . . Y          Y=Yes, N=No

Column headings:
Heading 1 . . . . . _____
Heading 2 . . . . . _____
Heading 3 . . . . . _____

Null Attribute . . . . . 3          1=Null, 2=Not null
                                       3=Not null with default

Variable length . . . . . N          Y=Yes, N=No

Allocated length . . . . . ____0    0-32740 characters

F3=Exit  F12=Cancel

More...

```

```

                                Character Field Options
Definition . . . . . : FIELDNAME          Dictionary . . . . . : MYDICT
Type choices, press Enter.

Keyboard shift for
display file reference . . . . . _      1=Select, 4=Remove

Long comment . . . . . _              1=Select, 4=Remove

Alternative name (Alias) . . . . . _____

Coded Character Set
Identifier (CCSID) . . . . . ____      1-65535

F3=Exit  F12=Cancel

Bottom

```

If you do not specify a shift, the system selects the appropriate shift. When you do specify a shift on the Character Field Options display, you go to the Specify Character Keyboard Shift display, where you can specify these shifts:

Alphanumeric

Lets all characters be entered.

Numeric only character

Allows entry of the digits 0 through 9, plus (+), minus (-), comma (,), period (.), and spaces.

Digits only

Allows entry of only the digits 0 through 9. No special characters or blanks are allowed.

Alphabetic only

Allows only alphabetic characters, comma (,), dash (-), and space be entered.

Numeric shift

Allows numeric entry; all characters are valid.

Katakana

Allows Katakana entry; all characters are valid.

Inhibit

Locks the keyboard so no data can be entered.

Numeric Keyboard Shift

To choose the keyboard shift for a numeric field, specify 1 (Select) for the *Keyboard shift for display file reference* prompt on the Numeric Field Options display.

```

                                Numeric Field Options
Definition . . . . . : NUMERIC           Dictionary . . . . . : MYDICT
Type choices, press Enter.
Numeric data type . . . . . 2  1=Zoned, 2=Packed
                               3=Binary, 4=Floating point
Column headings:
Heading 1 . . . . . _____
Heading 2 . . . . . _____
Heading 3 . . . . . _____
Null attribute . . . . . 3  1=NULL, 2=Not null
                               3=Not null with default
Numeric editing . . . . . _  1=Select, 4=Remove
Keyboard shift for
display file reference . . . . . _  1=Select, 4=Remove
More...
F3=Exit  F12=Cancel

```

```

                                Numeric Field Options
Definition . . . . . : NUMERIC           Dictionary . . . . . : MYDICT
Type choices, press Enter.
Long comment . . . . . _  1=Select, 4=Remove
Alternative name (Alias) . . . . . _____
Bottom
F3=Exit  F12=Cancel

```

When you do not specify a keyboard shift, the system default is signed shift, unless an edit code or edit word is specified. When either an edit code or edit word is specified, numeric only character shift is used. When you do specify a shift, the Specify Numeric Keyboard Shift display appears, where you can specify these shifts:

Signed

Allows numeric entry of only the digits 0 through 9. To leave the input field, the operator must press the Field Exit key, the Field + key, the Field - key, or a cursor movement key.

Numeric only character

Allows numeric entry of the digits 0 through 9, plus (+), minus (-), comma (,), period (.), and spaces.

Numeric

Allows numeric entry; all characters are valid.

Inhibit

Locks the keyboard so no data can be entered.

Digits only

Allows numeric entry of only the digits 0 through 9. No special characters or blanks are allowed.

DBCS Data Type

To control the keyboard data type for a double-byte character field, specify the correct option on the DBCS Field Options display.

```

                                DBCS Field Options
Definition . . . . . : DBCSFIELD      Dictionary . . . . . : MYDICT
Type choices, press Enter.
  DBCS data type . . . . . 1          1=Open, 2=Only
                                       3=Either, 4=Graphic
Column headings:
  Heading 1 . . . . . _____
  Heading 2 . . . . . _____
  Heading 3 . . . . . _____
Null attribute . . . . . 3           1=Null, 2=Not null
                                       3=Not null with default
Variable length . . . . . Y          Y=Yes, N=No
Allocated length . . . . . ____0     0-32740
                                       0-16370 (graphic only)
F3=Exit  F12=Cancel                                     More...
```

```

                                DBCS Field Options
Definition . . . . . : DBCSFIELD          Dictionary . . . . . : MYDICT
Type choices, press Enter.
Long comment . . . . . 1          1=Select, 4=Remove
Alternative name (Alias) . . . . . _____
Coded Character Set
Identification . . . . . _____ 1-65535

F3=Exit  F12=Cancel

Bottom

```

You can specify:

Open

Allows both single-byte character set (SBCS) and bracketed double-byte character set (DBCS) data to be entered.

Only

Allows only bracketed-DBCS data to be entered.

Either

Initially allows entry of SBCS data, but allows the operator to change and enter bracketed-DBCS data. The first character entered in a field determines what can be entered in the rest of the field.

Graphic

Allows only graphic (nonbracketed) DBCS data to be entered.

Date/Time Data Type

To control the format and separator type for the date and time section of your output, specify the correct option on the Date/Time Field Options display.

```

                                Date/Time Field Options
Definition . . . . . : DATEFIELD      Dictionary . . . . . : MYDICT
Type choices, press Enter.
Date/Time data type . . . . . 1  1=Date, 2=Time, 3=Timestamp
Column headings:
Heading 1 . . . . . _____
Heading 2 . . . . . _____
Heading 3 . . . . . _____
Null attribute . . . . . 3  1=NULL, 2=Not null
                          3=Not null with default
Date format . . . . . 2  1=*USA, 2=*ISO, 3=*EUR, 4=*JIS
                          5=*MDY, 6=*DMY, 7=*YMD, 8=*JUL
Date separator . . . . . _  1=/ 2=. 3=, 4=- 5=blank
More...
F3=Exit  F12=Cancel

```

```

                                Date/Time Field Options
Definition . . . . . : TIMEFIELD      Dictionary . . . . . : MYDICT
Type choices, press Enter.
Date/Time data type . . . . . 2  1=Date, 2=Time, 3=Timestamp
Column headings:
Heading 1 . . . . . _____
Heading 2 . . . . . _____
Heading 3 . . . . . _____
Null attribute . . . . . 3  1=NULL, 2=Not null
                          3=Not null with default
Time format . . . . . _  1=*USA, 2=*ISO, 3=*EUR, 4=*JIS
                          9=*HMS
Time separator . . . . . _  1=: 2=. 3=, 4=blank
More...
F3=Exit  F12=Cancel

```

Date/Time Field Options

Definition : TIMESTAMP Dictionary : MYDICT

Type choices, press Enter.

Date/Time data type 3 1=Date, 2=Time, 3=Timestamp

Column headings:

Heading 1 _____

Heading 2 _____

Heading 3 _____

Null attribute 3 1=NULL, 2=Not null
3=Not null with default

F3=Exit F12=Cancel

More...

Date/Time Field Options

Definition : TIMESTAMP Dictionary : MYDICT

Type choices, press Enter.

Long comment _ 1=Select, 4=Remove

Alternative name (Alias) _____

F3=Exit F12=Cancel

Bottom

Chapter 10. Record Format Definition Considerations

This chapter discusses record identification codes and how to use them effectively with program-described files.

Using Record Identification Codes

At times, you will want to perform a task using selected records from a program-described file (see Appendix C, “Data Descriptions on the AS/400 System”) instead of the entire file, as when the file has multiple formats (see “Record Format Definition Names” on page 5-3). For example, the file can have one format for names and addresses and another format for customer orders. You need record identification (ID) codes to identify which records are to be used with each format.

You should specify record ID codes when multiple record format definitions are used by a file definition for a file. If you do not use record ID codes to specify record selection comparisons, the system assumes you want to include all the records that can be read from the file. The system also assumes you want to process all the records using the first record format definition used by the file definition for the file.

You can select specific records by asking the system to search through the file for only those records that pass certain tests. The system will select records by making comparisons between the data in the file and the specified qualifying conditions. These qualifications are called record identification (ID) codes. Record ID codes specify tests that:

- Identify different record types contained in the file.
- Identify certain records in the file.

When you create a record format definition, use the Define Record ID Codes display to specify up to 70 tests used for identifying and selecting the records to be processed by the record format definition. Only character and zoned fields can be used for record ID codes.

```

                        Define Record ID Codes
Definition . . . . . : XXXXXXXXXXXX      Dictionary . . . . . : XXXXXXXXXXXX

Type field comparisons for record ID codes, press Enter.
  Tests:  EQ, NE, ZN, NZ, DG, ND

Field        Position  Test   Value  And/Or
-----
|-----|-----|-----|-----|-----|
|-----|-----|-----|-----|-----|
|-----|-----|-----|-----|-----|
|-----|-----|-----|-----|-----|
|-----|-----|-----|-----|-----|
|-----|-----|-----|-----|-----|XXXXXXXXXXXXX
-----
                        List of Field Definitions
Name          Length  Type           Name          Length  Type
XXXXXXXXXXXX  XXXXXXX  XXXXXXXXXXXX   XXXXXXXXXXXX  XXXXXXX  XXXXXXXXXXXX
XXXXXXXXXXXX  XXXXXXX  XXXXXXXXXXXX   XXXXXXXXXXXX  XXXXXXX  XXXXXXXXXXXX
XXXXXXXXXXXX  XXXXXXX  XXXXXXXXXXXX   XXXXXXXXXXXX  XXXXXXX  XXXXXXXXXXXX
XXXXXXXXXXXX  XXXXXXX  XXXXXXXXXXXX   XXXXXXXXXXXX  XXXXXXX  XXXXXXXXXXXX
XXXXXXXXXXXX  XXXXXXX  XXXXXXXXXXXX   XXXXXXXXXXXX  XXXXXXX  XXXXXXXXXXXX
                                          XXXXXXXXXXXX
F3=Exit      F11=Display text    F12=Cancel     F24=More keys

```

When you use Client Access to transfer an IDDU-defined file to the personal computer, you can select the record format definition you want to use to do the transfer. Using tests defined by the record ID code specified in the selected record format definition, Client Access transfers the records that pass those tests.

When you use AS/400 Query to report data in a file, or use the data file utility to add or update data in a file, you select a record format definition to be used in processing the file. The content of a field or fields within each record is compared with the record ID codes specified in the selected record format definition. If the specified conditions, or tests, are true (the data passes the tests specified by the record ID codes), the record is included in the report.

Chapter 11. File Definition Considerations

This chapter describes special functions available for file definition.

The performance of some applications can be improved by using keyed files and by accessing records by key. This chapter describes how to define key fields.

Selecting Key Field Sequence

Key fields allow you to arrange records within a file. For example, if you have a file of customer names and each customer's balance due your company, you can arrange the records either by the customer name (alphabetically) or by the balance due. The records, when balance due is the key field, can be ordered in descending sequence with the largest amount owed your company returned first.

When creating or changing a file definition using key fields, you can specify the following:

- Selection and sequence of key fields
- Ascending or descending sequence for each key field
- Key field value of signed, unsigned, absolute value, digit portion, or zone portion
- Whether duplicate keys are allowed
- Sequence of records with duplicate keys

If you enter Y at the *Select key field sequence* prompt on the Create File Definition or Change File Definition displays, the Select Key Field Sequence display appears.

Note: You may see the Create and Select Field Definition display immediately, or the Create and Select Record Format display may appear before the Select Key Field Sequence display appears.

```
                                Select Key Field Sequence
Definition . . . . . : XXXXXXXXX Dictionary . . . . . : XXXXXXXXX
Record format . . . . . : XXXXXXXXX

Type sequence number (0-9999), (and Field), press Enter.

Seq  Field          Length Type      Text
---  -
  1  XXXXXXXXX      XXXXXXX  XXXXXXXXX  XXXXXXXXXXXXXXXXXXXXXXXXXXXXXXXXXXXXXXX
```

When your selection of fields is complete, press the Enter key. (The display may be used for viewing only.) If changes were made, the display appears again so you can verify the changes. Press the Enter key again to proceed. If changes were not made, pressing the Enter key causes the process to continue.

Changing File Key Attributes

Additional key field sequencing attributes at the file level are available by pressing the F19 (Change file key attributes) on the Select Key Field Sequence display. These attributes apply to the entire key, which is the combination of all the key fields.

```
Change File Key Attributes
Definition . . . . . : XXXXXXXXXX      Dictionary . . . . . : XXXXXXXXXX
Type choices, press Enter.
  Allow duplicate key values . . . . . Y  Y=Yes, N=No
  Key order . . . . . 1  1=First in, first out
                       2=Last in, first out
                       3=First changed, first out
```

Note: The *Key order* prompt is only shown if you press the Enter key with Y (the default) in the *Allow duplicate key values* prompt.

The following explains the prompts on this display:

Definition

Name of the file definition you are creating or changing.

Dictionary

Name of the dictionary containing your file definition.

Allow duplicate key values

Type the letter of the appropriate option.

Y=Yes You want to allow records to have duplicate key values.

N=No You do not want to allow records to have duplicate key values.

When you choose Y and press the Enter key, the *Key order* prompt appears and you can specify how records with duplicate key values are retrieved from the file. When you select N and press the Enter key, the *Allow duplicate null fields* prompt appears and you can specify if you want null fields to be included.

Key order

Specify the order in which to retrieve records with duplicate key values from among the following options:

1=First in, first out

From the records with duplicate key values, you want to retrieve the first record added to the file, then the second record added, and so on.

2=Last in, first out

From the records with duplicate key values, you want to retrieve the last record added to the file, then the second-to-last record added, and so on.

3=First changed, first out

From the records with duplicate key values, you want to retrieve the record with the key value that was changed first,

then the record with the key value that was changed second, and so on.

Allow duplicate null fields

Specify whether a null field is to be considered a unique key or not. Although unique keys was specified in the *Allow duplicate key fields* prompt, you can further specify if null fields are to be included:

Y=Yes If a field you specified to be a key is also a null field, then this null field is allowed to have duplicates only for the null value.

N=No If a field you specified to be a key is also a null field, then this null field is also a unique key field.

Changing Key Field Sequence Attributes

You can define additional key field sequencing attributes by pressing F13 (Change key field sequence attributes) on the Select Key Fields display on page 11-1. The Change Key Field Sequence Attributes display allows changes in:

- *Order:*

Ascending

Records are arranged from lowest to highest key field value.

Descending

Records are arranged from highest value to lowest key field value.

- *Value:*

1=Signed Records are arranged using the numeric value of the key field. The data must be numeric.

2=Unsigned

Records are arranged using the character value of the key field. The data can be of any type.

3=Absolute value

Records are arranged using the absolute value of the key field, meaning the sign of the numeric value is ignored. The data must be numeric.

4=Digit portion

Records are arranged using only the right 4 bits in each byte of the key field. The data must be character or zoned decimal.

5=Zone portion

Records are arranged using only the left 4 bits in each byte of the key field. The field must be character or zoned decimal.

Change Key Field Sequence Attributes

Definition : XXXXXXXXX Dictionary : XXXXXXXXX
Record format : XXXXXXXXX

Type changes, press Enter.

A/D: A=Ascending, D=Descending

Value: 1=Signed, 2=Unsigned, 3=Absolute value

4=Digit portion, 5=Zone portion

A/D	Value	Field	Type	Text
A	d	XXXXXXXXX	XXXXXXXXX	XX
A	d	XXXXXXXXX	XXXXXXXXX	XX
A	d	XXXXXXXXX	XXXXXXXXX	XX
A	d	XXXXXXXXX	XXXXXXXXX	XX
A	d	XXXXXXXXX	XXXXXXXXX	XX

Chapter 12. Maintaining Definitions

To maintain definitions, choose option 1 (Work with definitions) on the Interactive Data Definition Utility (IDDU) menu or enter the Work with Data Definitions (WRKDTADFN) command on any command line. The Select Definition Type display will appear. Choose option 1 (Field), option 2 (Record format), or option 3 (File) and press the Enter key.

The Work with ... Definitions display will appear. On that display, you can choose to do the following:

- Create a new definition
- Change a definition
- Copy a definition
- Delete a definition
- Print or display the details of a definition
- Rename a definition
- Display the where-used information about a definition

```
Work with ... Definitions
Dictionary . . . . . : XXXXXXXXXXXX
Position to . . . . . _____ Starting characters
Type options (and File Definition), press Enter.
  1=Create  2=Change  3=Copy  4=Delete
  6=Print  7=Rename  8=Display where used
File      File      File      File
Opt  Definition  Opt  Definition  Opt  Definition  Opt  Definition
_   XXXXXXXXXXX  _   XXXXXXXXXXX  _   XXXXXXXXXXX  _   XXXXXXXXXXX
```

Creating definitions is discussed in Chapter 7, “Defining Fields,” Chapter 6, “Defining Record Formats,” and Chapter 5, “Defining Files.” You can choose up to 72 definitions to work with on the list display. The various tasks can be mixed on the same list, meaning that you can, for example, change one field definition and rename another.

Changing a Definition

Before you begin to change a definition, choose option 8 (Display where used) on the Work with ... Definitions display to confirm that the definition is not linked to a database file, because you cannot change a linked definition. IDDU does not check for this link until you attempt to save the changes. Linking and unlinking definitions and files is discussed in Chapter 14, “Maintenance Requiring Commands or Programming.”

This and other potential error conditions are not tested for until near the end of the definition process. Messages presented on the End ... Definition display describe the cause of any errors that prevent you from saving the definition.

When you choose to create or select field definitions, you go to the Create and Select Field Definitions display; see “Selecting a Field Definition” on page 6-6.

The *Specify record ID code* field is marked with a > when record ID codes have already been defined. If no record ID codes are defined, all the records are used for each format in the file. When you choose to specify record ID codes, you go to the Define Record ID codes display; see “Using Record Identification Codes” on page 10-1.

Changing a Field Definition

For a field definition, you can also specify the field characteristics.

The type of field can be character, numeric, DBCS, or date/time. You must specify the field size (except for date/time fields) and you can also enter a brief description. Numeric fields require that you specify the number of decimal positions.

When you choose to specify more options for each of the four types of fields, you can also work on field options displays. These additional options include column headings, null values, keyboard shift values, long comments, and an alias for the field described by the definition. See “Additional Characteristics for All Field Types” on page 7-6, and Chapter 9, “Field Editing Techniques,” for details about the additional options.

When a changed field is to be used in a record format ID code test, be sure that the data type of the field is specified only as zoned or character. This condition is not tested for until near the end of the definition process. If the data in a field is not either zoned or character, you will not be able to save the new definition. Record format ID codes are discussed in “Using Record Identification Codes” on page 10-1.

Also, do not change the size of a field definition so that the position tested for in a record format ID code test is greater than the new field size. This also is not tested for until near the end of the definition process. If you exceed the size limit you will not be able to save the definition.

Do not increase the length of a field if such an increase will make the total length of all fields in the record format definition greater than 32 766 bytes (32 740 bytes if a variable-length field is used).

Remember that only character (SBCS) and DBCS fields can be variable-length and that the maximum length of a variable-length field is 32 740 (16 370 for DBCS-graphic fields).

Do not make an alias the same as any other alias, or the same name as any field definition name that will be used by the same record format definition.

If a field is used as a key field, you cannot save a change that would exceed the maximum key length. Also, you cannot change to a data type that cannot provide the key field value specified in the file definition.

When you complete your work changing a field, use the End Field Definition display to confirm the work you did and to see the other definitions and database files affected by the changed definition. Remember that if any of your work causes errors, you will not be allowed to save your changes.

```

                                Copy ... Definition
From ...      . . . . . : XXXXXXXXXX      Dictionary. . . . . : XXXXXXXXXX
Created . . . . . : XXXXXXXXX      Created by. . . . . : XXXXXXXXXX
Text . . . . . : XXXXXXXXXXXXXXXXXXXXXXXXXXXXXXXXXXXXXXXXXXXXXXXXXXXXXXXX

Type choices, press Enter.

  To ... definition . . . . . default__ Name, F4 for list
    Dictionary . . . . . default__ Name, F4 for list

F3=Exit  F4=List  F12=Previous

```

On the Copy ... Definition display, type a name for this copy of the definition and the name of the dictionary into which you want the copy placed.

On the Copy ... Definition display, you can see the name of the definition you are copying, the dictionary it is in, the date when it was created and the user ID of the person who created it. Also, if one was entered, a brief description of the definition is shown.

When you are copying a file definition or a record format definition into a different dictionary, new versions of the definitions used by the file or record format will be created in the (copied to) dictionary if identical versions do not already exist.

After you press the Enter key on the Copy ... Definition display, you will go to the Confirm Copy display. Use that display to confirm or cancel the copying of the definition.

```

                                Confirm Copy

Copy ... Definition
From . . . . . : XXXXXXXXXX      Dictionary . . . . . : XXXXXXXXXX
To . . . . . : XXXXXXXXXX      Dictionary . . . . . : XXXXXXXXXX

Type choice, press Enter.
  Copy definitions . . . . . Y Y=Yes, N=No

                                Definitions to be Included in the Copy
Definition Type      Definition Type      Definition Type
XXXXXXXXXX XXXXXXXXXXXX XXXXXXXXXX XXXXXXXXXXXX XXXXXXXXXX XXXXXXXXXXXX
XXXXXXXXXX XXXXXXXXXXXX XXXXXXXXXX XXXXXXXXXXXX XXXXXXXXXX XXXXXXXXXXXX
XXXXXXXXXX XXXXXXXXXXXX XXXXXXXXXX XXXXXXXXXXXX XXXXXXXXXX XXXXXXXXXXXX

```

The confirmation display gives you the opportunity to check the name of the definition being copied, and the name being assigned to the copy, as well as the names of any other definitions that will be included in the copy.

Deleting Definitions

You can delete a file, record format, or field definition by choosing option 4 (Delete) on the Work with ... Definitions display. Type the name of the definition to be deleted and press the Enter key. The following Confirm Delete of ... Definition display is shown.

```
Confirm Delete of ... Definition
Definition . . . . . : XXXXXXXXXX      Dictionary . . . . . : XXXXXXXXXX
Created . . . . . : XXXXXXXXXX      Created by . . . . . : XXXXXXXXXX
Text . . . . . : XXXXXXXXXXXXXXXXXXXXXXXXXXXXXXXXXXXXXXXXXXXXXXXXXXXXXXXX

Type choice, press Enter.

Delete . . . . . Y      Y=Yes, N=No

List of Items Affected by Delete

Definition Type      Msg      Definition Type      Msg
XXXXXXXXXX XXXXXXXXXXXXXXX XXXX      XXXXXXXXXXX XXXXXXXXXXXXXXX XXXX
XXXXXXXXXX XXXXXXXXXXXXXXX XXXX      XXXXXXXXXXX XXXXXXXXXXXXXXX XXXX
XXXXXXXXXX XXXXXXXXXXXXXXX XXXX      XXXXXXXXXXX XXXXXXXXXXXXXXX XXXX
XXXXXXXXXX XXXXXXXXXXXXXXX XXXX      XXXXXXXXXXX XXXXXXXXXXXXXXX XXXX
XXXXXXXXXX XXXXXXXXXXXXXXX XXXX      XXXXXXXXXXX XXXXXXXXXXXXXXX XXXX
XXXXXXXXXX XXXXXXXXXXXXXXX XXXX      XXXXXXXXXXX XXXXXXXXXXXXXXX XXXX

F3=Exit  F11=Display text      F12=Cancel
```

Use the Confirm Delete of ... Definition display to be sure that you are deleting the appropriate definition, and to determine what items will be affected by the deletion.

You will not be allowed to delete a definition if:

- A file definition is linked to a database file.
- A record format definition is the only one in a file definition.
- A field is used as a key field or in a record format ID test.
- A field definition is the only one used by a record format.

You will get a message when you attempt the deletion if it will cause errors in a related definition or file.

Printing Definitions

On the Work with ... Definition display, name the definition to print, and choose option 6 (Print). When you press the Enter key, you see the following Print Options display, where you confirm the name of the data definition you named on the Work with ... Definitions display as the definition you want to print. If necessary, you can change this to the name of a different definition.

```

                                Print Options
Dictionary . . . . . : XXXXXXXXXX
Type choices, press Enter.
Definition type . . . . . _          1=File, 2=Format, 3=Field
Definition . . . . . _____ *ALL, Name
Creation date . . . . . _____
File information . . . . . 1          1=Basic, 2=Detail,
                                    3=Extended, 4=All, 5=None
Format information . . . . . 1        1=Basic, 3=Extended, 4=All
                                    5=None
Field information . . . . . 1         1=Basic, 2=Detail,
                                    3=Extended, 4=All, 5=None
Printer device . . . . . *PRINT____ *PRINT, *, Name
F3=Exit  F12=Previous

```

On this display you choose the level of detail to print or display, and you can specify the name of a printer device (a printer or a print queue). You can also display the definition (rather than printing it) by specifying an * for the *Printer* prompt.

Note: You can also print or display the contents of a data dictionary with the Display Data Dictionary (DSPDTADCT) command, described in Appendix D, “IDDU Commands.”

For a definition, you can choose to print:

- A *basic* summary of a definition, listing the following:
 - The name and type of the definition.
 - The dictionary containing the definition.
 - For a file, the number of record formats contained.
 - For a format, the number of fields and the record length.
 - For a field, the data type, field length, number of decimal positions, and any column headings. When file or record format definitions are printed, the basic field information also includes buffer length, buffer position, and field usage.
 - Any descriptive text associated with the definition.
- A *detailed* summary of a field definition, which includes all basic information as well as the creation date and user-ID of the person who created it, and the last-change date and user-ID of the person who last changed it, plus any alias, keyboard shift, or numeric editing information.
- A *detailed* summary of a file definition, which includes all basic information plus any key field information.
- An *extended* summary of a definition, which prints all the information printed in a basic, or detailed, listing plus any long comment.

- *All* of the information, which includes the extended listing plus the where-used information for a definition. In addition, for a record format, the record ID code information is printed.

Figure 12-1 is an example of a *complete* file definition printout that illustrates the level of detail available. You must have the capability to print 132 columns to be sure of seeing all of the detail printed.

570xSSx R0x M0x 611111 Display File/Field Information

Dictionary : SYSDICT
Definition or generic* : FILEDEFN
Definition type : *FILE
File information : *ALL
Record format information : *ALL
Field information : *BASIC

File Information

File name : FILEDEFN
Number of record formats : 1
Type of file : Physical
Last changed : 03/06/84
Changed by : ARCHER
Created : 11/04/83
Created by : MILLER
File text : practice definition for DFU and Query

Record Format Information

Record format name : NAMEADDRR
Number of fields : 8
Record length : 95
Last changed : 08/06/83
Changed by : COOPER
Created : 03/04/82
Created by : FENSTER

Record Format Where Used List

Name	Type	Lib/Date	Text
FILEDEFN	FILE DEF	12/29/83	practice definition for DFU and Query

Field Level Information

Field	Data Type	Field Length	Buffer Length	Buffer Position	Field Usage	Column Heading
LASTNAME	CHAR	15	15	1	Both	
						Field text : Last name
FIRSTNAME	CHAR	10	10	16	Both	
						Field text : First name
ADDRESS1	CHAR	20	20	26	Both	
						Field text : Address line 1
ADDRESS2	CHAR	20	20	46	Both	
						Field text : Address line 2
CITY	CHAR	15	15	66	Both	
						Field text : City
STATE	CHAR	2	2	81	Both	
						Field text : State
ZIP	CHAR	9	9	83	Both	
						Field text : Zip code
AMOUNT	PACKED	6 2	4	92	Both	
						Field text : Amount

Figure 12-1. Example of All Information Printed for a File Definition

```
Recover ... Definition Changes
Definition . . . . . : XXXXXXXXXX      Dictionary . . . . . : XXXXXXXXXX
Created . . . . . : XXXXXXXXXX      Created by . . . . . : XXXXXXXXXX
Last changed . . . . . : XXXXXXXXXX      Changed by . . . . . : XXXXXXXXXX
Text . . . . . : XXXXXXXXXXXXXXXXXXXXXXXXXXXXXXXXXXXXXXXXXXXXXXXXXXXXXXXX

Date when definition was interrupted. . . . . : XXXXXXXX
User ID of person working with definition . . . . . : XXXXXXXX

The last request for the definition ended abnormally.
Select one of the following:
    1. Attempt recovery of changes made to the interrupted definition
    2. Delete changes to the interrupted definition

Selection
===>
```

The *Created*, *Created by*, *Last changed*, and *Changed by* fields are not shown on the Recover ... Definition Work display.

You can either attempt to recover and resume the interrupted session or continue with your current task, discarding the information saved from the interrupted session. The attempt to recover will begin at the appropriate Change (or Create) Definition display.

Chapter 13. Maintaining Data Dictionaries

To maintain dictionaries, choose option 2 (Work with data dictionaries) on the Interactive Data Definition Utility (IDDU) menu, or enter the Work with Data Dictionaries (WRKDTADCT) command on any command line.

Use the Work with Data Dictionaries display to choose the dictionary to maintain and to describe the kind of maintenance you want to do. On that display, you can choose to:

- Create a new dictionary
- Change a dictionary
- Delete a dictionary
- Print information about a dictionary

```
Work with Data Dictionaries
Position to . . . . . _____ Starting characters
Type options (and Data Dictionary), press Enter.
  1=Create  2=Change  4=Delete  6=Print
Opt  Data      Opt  Data      Opt  Data      Opt  Data
  1  Dictionary Dictionary Dictionary Dictionary
  -  SALES      -  BCXXXXXXX -  CEXXXXXXXX -  EBXXXXXXX
  -  AAXXXXXXXX
```

Creating dictionaries is discussed in Chapter 4, “Working with Data Dictionaries.”

Additionally, you can do maintenance of dictionaries that does not use the Work with Data Dictionaries display. This includes:

- Saving a dictionary
- Restoring a dictionary
- Renaming a dictionary

These tasks are described later in this chapter, as is the effect on dictionary use of definitions created or used by the Structured Query Language/400 (SQL/400*) language.

Chapter 14, “Maintenance Requiring Commands or Programming,” describes other work with dictionaries, including:

- Changing dictionary definitions linked to a file
- Changing copies of dictionary definitions
- Adding definitions from an externally described file to a dictionary

Changing a Data Dictionary

For any data dictionary you have created, you can change the level of security by changing the access authority of others to the definitions. You can also change the long comment and the text that describe the dictionary. To make changes, choose option 2 on the Work with Data Dictionaries display and specify the dictionary you want to work with. Then, on the Change Data Dictionary display, you can:

- Press F18 (Change authority) to specify the changes you want to make to the access of others to the dictionary and its data definitions. Choose option 1 (Select) to view or change the *Long comment*. You can also choose option 4 (Remove) to delete it entirely (or press the spacebar for a space to keep it as is).
- Type in any change to the *Text description*.

Note: You cannot *rename* a dictionary or a library that contains a dictionary; this is not the same as *changing* a dictionary. However, you can restore a dictionary to a library you have named, at which time the dictionary copy will have the name of the library into which it was “restored.”

Deleting a Data Dictionary

To delete a dictionary, choose option 4 (Delete) on the Work with Data Dictionaries display and specify the dictionary you want to delete. You then see the Confirm Delete of Data Dictionary display, where you can verify the name and description of the dictionary specified to be deleted. You can also use the Delete Data Dictionary (DLTDTADCT) command described in Appendix D, “IDDU Commands.” With the DLTDTADCT command, a message appears telling you if the delete was successful.

```

                                Confirm Delete of Data Dictionary
Dictionary . . . . . : DICTNAME
Text . . . . . : ANY TEXT ENTERED ABOUT THIS DICTIONARY AND ITS USE

Type choice, press Enter.
Delete . . . . . Y Y=Yes, N=No

                                List of Items Affected by Delete
Name          Type          Msg          Name          Type          Msg
xxxxxxxxxxx  xxxxxxxxxxxxxxx  xxxxx      xxxxxxxxxxx  xxxxxxxxxxxxxxx  xxxxx
xxxxxxxxxxx  xxxxxxxxxxxxxxx  xxxxx      xxxxxxxxxxx  xxxxxxxxxxxxxxx  xxxxx
xxxxxxxxxxx  xxxxxxxxxxxxxxx  xxxxx      xxxxxxxxxxx  xxxxxxxxxxxxxxx  xxxxx

```

To confirm that you really do want to delete a dictionary, type a Y for the *Delete* prompt; or, if necessary, you can cancel the deletion by typing an N for this prompt.

When a dictionary is linked to an externally described file, the links are removed during the deletion. You cannot delete a dictionary while it is linked to a program-described file. You must use the Link Data Definition (LNKDTADFN) command described in Appendix D, “IDDU Commands,” to unlink them.

Printing the Contents of a Data Dictionary

You can choose to print the contents of a dictionary and name the dictionary to print from using the Work with Data Dictionaries display. When you press the Enter key, you see the following Print Options display, where you choose the types of definitions (field definition, record format definition, or file definition) and the level of information you want to print for each type of definition.

```

                                Print Options
Dictionary . . . . . : XXXXXXXXXX
Type choices, press Enter.
Definition type . . . . . _          1=File, 2=Format, 3=Field
Definition . . . . . _____ *ALL, Name
Creation date . . . . . _____
File information . . . . . 1          1=Basic, 2=Detail,
3=Extended, 4=All, 5=None
Format information . . . . . 1          1=Basic, 3=Extended, 4=All
5=None
Field information . . . . . 1          1=Basic, 2=Detail,
3=Extended, 4=All, 5=None
Printer device . . . . . *PRINT____ *PRINT, *, Name
F3=Exit  F12=Previous

```

The level of detail printed is the same as for printing the individual definitions, as described under “Printing Definitions” on page 12-6. Alternatively, you can view the contents of a data dictionary with the Display Data Dictionary (DSPDTADCT) command described in Appendix D, “IDDU Commands.”

Other Dictionary Maintenance

There are other tasks you might want to perform when working with dictionaries, such as saving or renaming a dictionary. There are no IDDU options to do these things, but it is possible to do them by using AS/400 commands and features.

Data Dictionary Recovery: Saving and Restoring

A dictionary is saved and restored as part of the SAVLIB and RSTLIB commands. To be able to recover the definitions in a dictionary, you must save (copy) the library containing the definitions to another medium, such as tape or diskette, at regular intervals, and keep the copy in another secure place away from the immediate area of the system.

Note: Interrupted work in progress from create or change operations is not saved or restored when the dictionary is saved or restored.

When it becomes necessary to restore the dictionary (or any part of the library), you have only to reload the saved files from the backup medium using the RSTLIB command after deleting the existing dictionary. To recover individual definitions, see “Recovering a Definition” on page 12-11. When files existing in one library are dependent on the definitions in another library’s dictionary, the library containing the data dictionary should be restored first. This would be the case if a file were linked to the definitions in a different library, or if a logical file has been created that depends on the definitions in a different library.

Note: A dictionary that contains or has contained variable-length character, DBCS, null-capable, or date/time fields cannot be saved prior to Version 2 Release 1.1. A dictionary that contains or has contained DBCS-graphic fields or file

definitions with a key length greater than 120 bytes (115 bytes for FCFO) cannot be saved prior to Version 2 Release 2.

For more general information about saving and restoring libraries and about using the SAVLIB and RSTLIB commands, see *CL Reference* and *Backup and Recovery*.

Copying a Data Dictionary

You can copy a dictionary by creating a new dictionary and then copying the definitions of the original dictionary into the new one using the technique described in “Copying Definitions” on page 12-4. When you copy a file definition, all of the definitions used by that file definition are also copied. The only definitions in the dictionary that would not be automatically copied are those that are not being used. Another technique would be to save and rename the dictionary as described in “Renaming a Data Dictionary.”

Renaming a Data Dictionary

Rename a dictionary by saving the library containing the dictionary and restoring it under a different name.

Considerations When SQL/400 Users Share Dictionaries

If IDDU users and SQL users share dictionaries, there are certain topics that must be considered, including terminology and definitions.

SQL Terminology

SQL uses its own terminology in naming objects. When SQL creates a collection, it is actually a library with a dictionary. When SQL creates a table, it is actually a file with a definition. In general, the definitions in the dictionary can be worked with by using IDDU. The following table shows the relationship between AS/400 object names and SQL object names:

System Terms	SQL Terms
Library: Groups related objects and allows the user to find the objects by name.	Collection: Consists of a library, a journal, a journal receiver, a data dictionary, and a SQL catalog. A collection groups related objects and allows the user to find the object by name.
Physical file: A set of records.	Table: A set of columns and rows.
Record: A set of fields.	Row: The horizontal part of a table containing a serial set of columns.
Field: One or more characters of related information of one data type.	Column: The vertical part of a table of one data type.
Logical file: A subset of the fields and records of one or more physical files.	View: A subset of the columns and rows of one or more tables.

When SQL users and IDDU users share the same dictionary, some definitions created by one may be used by the other. Both IDDU users and SQL users must understand how they will affect each other.

SQL Definitions Used by IDDU

When a definition is created by SQL, it is immediately linked to a file. IDDU users can use the definition, print it, copy it, or view where it is used while it is still linked. When the definition is no longer linked, then IDDU can be used to change or delete it.

When SQL no longer needs a definition, it is deleted unless it has been used by IDDU. If the definition has been used by IDDU, it will not be dropped from the dictionary when the SQL table is dropped. Only through SQL can you delete definitions created and used only by SQL (and then only when the definition is not linked to a file).

IDDU Definitions Used by SQL

SQL users can use a definition created by IDDU. When SQL needs a definition, the dictionary is searched for a similar definition. When a matching definition is found, it is used rather than creating a new definition.

Because SQL automatically links the definitions to files, definitions being used by SQL cannot be deleted or changed by IDDU users. IDDU users can continue to use the definition. They can print it, copy it, and view where it is used.

SQL deletes a definition when it is no longer needed, unless it is used by another file. However, SQL only deletes definitions created by SQL. Definitions created by IDDU are not deleted by SQL.

Unsupported SQL

SQL-created files are linked to the data dictionary associated with the collection when the file is created. The Add Data Definition (ADDDTADFN) command does not support SQL-created files because of this link. An error message informs you that the command does not operate on SQL files.

Dictionaries created by SQL cannot be deleted using IDDU unless they have been created as part of a library during a restore operation. Also, IDDU cannot restore a SQL dictionary into an existing library. The library to receive the dictionary must be created by the restore command. SQL files cannot be linked again to different dictionaries.

Chapter 14. Maintenance Requiring Commands or Programming

Many operations related to data dictionaries require that the link between a file definition and a file be created or removed. The two commands used to manipulate links are the Link Data Definition (LNKDTADFN) command and the Add Data Definition (ADDDTADFN) command.

In other cases, various other control language commands not directly related to IDDU must be used. Yet other operations require that various programming languages be used because they support the type of data being worked on.

Linking and Unlinking Files and Definitions

You can link and unlink data definitions and the files they describe using the Link Data Definition (LNKDTADFN) command discussed in Appendix D, "IDDU Commands." Program-described files and externally described files can be unlinked using the LNKDTADFN command, but only program-described files can be linked using the LNKDTADFN *LINK command. Externally described files must be linked using the ADDDTADFN command.

Note: The LNKDTADFN *UNLINK *ALL command only unlinks program-described files. Externally described files must be unlinked one at a time when using the LNKDTADFN command to unlink.

Additionally, the following considerations apply:

- When a file is linked, the text of the definition becomes the text of the file.
- A file can be linked to only one definition, but a definition can be linked to multiple files.
- When linking a keyed file, the starting and ending positions of the key must match the starting and ending positions of fields in the definition. If the starting and ending positions do not match, the file and file definition cannot be linked.
- A definition cannot be linked to if it contains a date/time field, variable-length field, null-capable field, or DBCS-graphic field.
- A file must be in the same auxiliary storage pool as the definition to which the file is being linked.

Creating Definitions from Files

The Add Data Definition (ADDDTADFN) command allows you to add the definitions of an externally described file to an existing data dictionary. These definitions then become available for use with other files through the dictionary.

To use the command, you must know the name of the file and the library containing it (library name/file name) so the file's name and library can be added to the specified dictionary. The default library for the file is *LIBL, or you can specify *CURLIB for the library if you know the name of the current library.

You can place the file definition in any dictionary in any library to which you are authorized. For example:

```
ADDDTADFN FILE(MYLIB/MYDEF) DCT(MINE)
```

adds the definition of the file MYDEF, found in library MYLIB, to dictionary MINE.

The ADDDTADFN command also creates a link between the file and the definition. If you use the command again with the same file, the first link is dropped, and the file is linked to the new definition.

Not all file definitions can be added to a dictionary using the ADDDTADFN command. In general, these can be added:

- Physical files
- Nonjoin logical files with one format and no select/omit specifications

When a database file uses a function not supported by IDDU, all of the file's descriptions might not be added to the dictionary by the ADDDTADFN command, and only field and record format definitions are created. Database files using the following functions lose the description of the given function, and the file definition is not created:

- Field default values
- Field validity check codes
- Key fields defined using names based on a physical file

Descriptions of the following functions are dropped on an ADDDTADFN command. However, a file definition is still created.

- Derived fields
- Renamed fields

Database files using the following functions do not have any definitions added to a dictionary by the ADDDTADFN command:

- Access path sharing
- Alternative collating sequence

Making Changes to Definitions That Affect Files

The definitions in a dictionary describing a file cannot be changed while the file is linked to the definitions. Linking and unlinking program-described database files using the Link Data Definition (LNKDTADFN) command is discussed in "Linking and Unlinking Files and Definitions" on page 14-1. Externally described database files created using IDDU can be unlinked using the LNKDTADFN command, but cannot be linked again using the LNKDTADFN command. For these files, it is necessary to use the Add Data Definition (ADDDTADFN) command to place the file's definitions in a dictionary. This process forces the link between the file and the definitions in the original dictionary to be opened. The ADDDTADFN command is discussed in "Creating Definitions from Files" on page 14-1.

After the file is unlinked from its definitions, you can add fields or make other changes to the definitions. See Chapter 12, "Maintaining Definitions" for information about changing the file, field, and record format definitions that describe a file.

Changes Affecting Externally Described Files

When you change a dictionary definition that affects externally described files, use the following process:

1. Use the Display Where File Definition Used display to determine which files are affected by a change. Select this display from the Work with File Definitions display. See “Linking and Unlinking Files and Definitions” on page 14-1 for more information about the effects of unlinking a definition.
2. Save the files so that backup copies will be available if needed.
3. Remove the link between the files and the definitions. Externally described files can be unlinked with the LNKDTADFN command, or you can change the links to another (temporary) dictionary with the ADDDTADFN command. Create the temporary dictionary by using:

- a. CRTLIB tempdict
- b. CRTDTADCT tempdict
- c. ADDDTADFN filename tempdict

Repeat the ADDDTADFN command for each externally described file affected if you choose not to use the LNKDTADFN command.

4. Rename the files by using:

```
RNM0BJ filename *FILE tempfile
```
5. Change the definitions with IDDU. See Chapter 12, “Maintaining Definitions.”
6. Create new files with the original names using IDDU. See Chapter 12, “Maintaining Definitions.”
7. Copy the data from the original files to the new files. See “Copying Data Files” on page 14-5.
8. Delete the original files and temporary dictionary by using:
 - a. DLTF tempfile
 - b. DLTDTADCT tempdict
 - c. DLTLIB tempdict
9. If any queries are defined for the files, the AS/400 Query definitions need to be updated. See *Query/400 Use*.
10. Save the new files so that backup copies are available if needed.

Changes Affecting Program-Described Files

The processes used to change a dictionary definition affecting program-described files differ depending on whether the fields are being altered. The methods following are specific to either unchanged or changed fields.

Record Length and Field Positions Unchanged

Use the following process when you change a dictionary definition that affects program-described files, and if fields are *not* being added, deleted, resequenced, or changed in size or type:

1. Remove the link between the files and the definitions.

```
LNKDTADFN *UNLINK filename
```

2. Change the definitions with IDDU. See Chapter 12, “Maintaining Definitions.”
3. Link the definitions and the files again.

LNKDTADFN *LINK filename dictionary definition date (or *FIRST)

4. If any queries are defined for the file, the query definitions must be updated.
See *Query/400 Use*.

Record Length and Field Positions Changed

Use the following process when you change a definition that affects program-described files, and fields are being added, deleted, sequenced again, or changed in size or type:

1. Save the files so that a backup copy is available if needed.
2. Remove the link between the files and the definitions.

LNKDTADFN *UNLINK filename

3. Rename the files.

RNMOBJ filename *FILE tempfile

4. Change the definitions with IDDU. See Chapter 12, "Maintaining Definitions."
5. Create a new file with the original name using IDDU. See Chapter 8, "Working with Database Files."
6. Copy the data from the original files to the new files.

In most cases this will require you to create a program to perform the necessary data conversions. However, if the only change is adding fields to the end of a record format, you can use the following command.

CPYF tempfile filename FROMMBR(*ALL) TOMBR(*FROMMBR) MBROPT(*ADD) FMTOPT(*NOCHK)

Refer to the *CL Reference* for more information on the CPYF command.

7. Delete the original files.

DLTF tempfile

8. If any queries are defined for the files, the query definitions must be updated.
See *Query/400 Use*.
9. Save the new files so that backup copies are available if needed.

Creating a New Version of a Definition

You can also change definitions affecting files by copying the definitions and changing the copied versions. This process can be used for either externally described or program-described files, as follows:

1. Create new versions of the definitions to be changed.
 - a. Copy each definition to a temporary name.
 - b. Rename the new definition to match the original name.
 - c. Change the new version.
2. For each upper-level definition affected (for example, a file definition), create a new version that selects the changed definition.
 - a. Copy each definition to a temporary name.
 - b. Rename the new definition to match the original name.
 - c. Change the new version (of the upper-level definition) to select the new version of the lower-level definition (for example, a record format definition).
3. For each file affected, create a new file with the same name.
 - a. Save the original files so that backup copies are available if needed.

b. Rename the files.

```
RNM0BJ filename *FILE tempfile
```

c. Create a new file with the original name using IDDU. See Chapter 8, “Working with Database Files.”

4. Copy the data from the original files to the new files. See “Copying Data Files.”

5. Delete the original files.

```
DLTF tempfile
```

6. Delete the original versions of all changed definitions.

7. If any queries are defined for the file, the query definitions must be updated. See *Query/400 Use*.

8. Save the new files so that backup copies are available if needed.

Copying Data Files

In many cases, the data can be copied using the Copy File (CPYF) command. In some cases, however, you will need to create a program to copy the data. When using the CPYF command, you need to determine whether the data can be copied exactly, or if changes are required as it is copied.

Refer to *Data Management* for more information on the CPYF command.

Data Unchanged

If the data can be copied exactly, use the CPYF command:

```
CPYF tempfile filename FROMMBR(*ALL) TOMBR(*FROMMBR) MBROPT(*ADD) FMTOPT(*NOCHK)
```

The data can be copied exactly for the following types of changes:

- Renaming a definition
- Changing a definition’s text or long comment
- Changing a field’s column headings, editing characteristics, keyboard shift, or alternative (alias) name
- Adding fields to the end of a record format
- Changing record ID codes for a record format
- Adding or sequencing record formats again within a file definition
- Deleting a record format from a file definition, if the record length of the file remains the same
- Changing a character field to a zoned numeric field of the same size
- Changing a zoned numeric field to a character field of the same size
- Changing a character field to a DBCS field of the same size
- Changing a DBCS field to a character field of the same size
- Changing decimal positions for a zoned or packed numeric field
- Selecting key fields for a file definition

Data Converted

For externally described files, the CPYF command can perform some conversions while copying the data.

Changes other than those listed here will require that you to create a high-level language program to copy the data; for example, changing a character field to a numeric field other than zoned numeric. You must use a programming language that supports the types of data being converted.

```
CPYF tempfile filename FROMMBR(*ALL) TOMBR(*FROMMBR) MBROPT(*ADD) FMTOPT(*MAP *DROP)
```

The data can be converted by the CPYF command for the following types of changes:

- Adding fields to a record format definition (the CPYF command inserts default values for new fields)
- Deleting fields from a record format definition (the data for these fields is deleted during the copy)
- Sequencing fields again in a record format definition
- Changing the size of a field (the data is either padded or truncated)
- Changing the numeric field from one numeric type to another (unless it is a binary field with decimal positions greater than zero, which cannot be changed)

Differences between Program-Described and Externally Described Files

Whether a file is externally described or program-described affects how certain commands operate on the file and the dictionary associated with the file.

Restore or Create Duplicate Object

On a restore, copy, or Create Duplicate Object (CRTDUPOBJ) of a database file, if the original file is linked, the system attempts to link the new file.

When the original file is linked to the dictionary in the library containing the file, and the library containing the new file also contains a dictionary, the system attempts to link the new file to the dictionary in the library containing the new file. For program-described files there is no assurance that the definition matches the old definition, and if the definition is not found, the file is not linked. If no dictionary exists in the *To* library, the link is made to the original dictionary.

Change File

When a linked, externally described file is changed using the Change Physical File (CHGPF) or Change Logical File (CHGLF) commands, the new definition of the file is added to the data dictionary.

When a linked program-described file is changed, no change is made to the data dictionary.

Chapter 15. AS/400 Security and IDDU

This chapter explains the levels of authority needed to work with IDDU. It covers dictionaries, libraries, and files, as well as the commands required to perform the tasks.

Authority Requirements for IDDU Operations

Figure 15-1 shows the generic levels of authority required for operations with IDDU. When the generic level includes specific rights, this is indicated by a footnote number after a generic level. These footnote numbers indicate the entry in the "Authority/Rights Table" on page 15-2 that shows the relationship between the generic authority level and the specific rights.

In all of the tables, the entry **na** indicates a not-applicable item.

Figure 15-1. Generic Levels of Authority with IDDU

Authority Required to:	Dictionary	Library	File	Library	Command/Authority
Work with Dictionaries	na	na	na	na	WRKDTADCT *USE
Create Dictionary	na	*CHG 1.	na	na	CRTDTADCT *USE
Change Dictionary	*ALL 1.	*USE 1.	na	na	
Delete Dictionary	*ALL 3.	*USE 1.	na	na	DLTDTADCT *USE
Print Dictionary	*USE	*USE 1.	na	na	DSPDTADCT *USE
Work with Definitions	na	na	na	na	WRKDTADFN *USE
Select Dfn Type	*USE	*USE 1.	na	na	
Create Definition	*CHANGE	*USE 1.	na	na	
Change Definition	*CHANGE	*USE 1.	na	na	
Copy Dfn from Dict	*USE	*USE 1.	na	na	
Copy Dfn to Dict	*CHANGE	*USE 1.	na	na	
Delete Definition	*CHANGE	*USE 1.	na	na	
Print Definition	*USE	*USE 1.	na	na	DSPDTADCT *USE
Rename Definition	*CHANGE	*USE 1.	na	na	
Display Where Used	*USE	*USE 1.	na	na	
Work with DB Files	na	na	na	na	WRKDBFIDD *USE
Create File					
Authority holder	*USE	*USE 1.	*ALL	*CHG 1.	CRTPF *USE
No authority holder	*USE	*USE 1.	na	*CHG 1.	CRTPF *USE
Enter Data (DFU)	*USE	*USE 1.	*USE	*USE 1.	UPDDTA *USE
add change delete		*USE 1.	*CHANGE	*USE 1.	
Start IDDU via command	na	na	na	na	STRIDD *USE
Add Definitions	*CHANGE	*USE 1.	*ALL 2.	*USE 1.	ADDDTADFN *USE
Link File & Definition	*USE	*USE 1.	*ALL 2.	*USE 1.	LNKDTADFN *USE
Unlink File	na	*USE 1.	*ALL 2.	*USE 1.	LNKDTADFN *USE

The following tables show levels of authority required for operations done outside of IDDU and how generic authority levels correspond to specific rights.

Authority Requirements for Non-IDDU Dictionary Operations

Figure 15-2 shows the generic levels of authority required for dictionary operations done outside of IDDU. When the generic level includes specific rights, this is indicated by a number after the generic level. In these cases, see Figure 15-3, for the relationship between the generic authority level and the specific rights.

Figure 15-2. Generic Levels of Authority for Dictionary Operations

Authority Required to:	Dictionary	Library	Dictionary Files	Other	Command/Authority
Change Dict Ownership	See Security Guide		*ALL 4.		CHGOBJOWN *USE
Save Dictionary	*ALL 4.	*USE	*ALL 4.	na	SAVLIB *USE
Restore Dictionary	*ALL 4.	*CHANGE 2.	*ALL 4.	na	RSTLIB *USE

When you have special save system authority (*SAVSYS), the authorities listed for saving and restoring a dictionary are not required.

Authority/Rights Table

Figure 15-3 shows how generic authority levels correspond to specific rights.

Figure 15-3. Generic Authority Levels and Specific Rights

Object Authority	Object Rights			Data Authority			
	Opr	Mgt	Exist	Read	Add	Update	Delete
*ALL	X	X	X	X	X	X	X
*ALL 1.	X	X		X	X	X	X
*ALL 2.	X	X					
*ALL 3.	X		X				
*ALL 4.			X				
*CHANGE	X			X	X	X	X
*CHANGE 1.				X	X		
*CHANGE 2.	X			X	X		
*USE	X			X			
*USE 1.				X			
*EXCLUDE							

Chapter 16. Dictionary Files

This appendix lists the files that are used by IDDU. These include the files that make up each dictionary created by IDDU and the system-wide cross-reference files created when OS/400 is installed.

As initially created, these files have *EXCLUDE authority assigned to them. The authority level must be changed to the *USE level for any files that are to be accessed.

These files can be read directly by a high-level language program or by a query. Detailed information about the internal content and organization of the files is available by using the Display File Field Description (DSPFFD) command.

Data Dictionary Files

When a dictionary is created, these files are created in the library containing the dictionary. They are used by IDDU to store the data definitions and other dictionary information.

File ID	File Purpose	Description
QIDCTP02	Dictionary Comments	Long comments for definitions
QIDCTP10	Field Attributes	Field definitions
QIDCTP20	Record Format Attributes	Record format definitions
QIDCTP21	Record Format's Fields	Fields in record format definitions
QIDCTP25	Record Format's Record ID Tests	Record format ID tests in record format definitions
QIDCTP30	File Attributes	File definitions
QIDCTP31	File's Record Format	Record formats in file definitions
QIDCTP51	Key Fields	Key fields in file descriptions
QIDCTP52	File's SQL/400 Create Text	SQL create text in file definitions
QIDCTP53	Logical File's Physical	Physical file of a logical file

Associated Logical Files

The following logical files provide alternative presentations of some of the data from the dictionary definition files.

File ID	File Purpose	Description
QIDCTL76	Fields by Alias	Fields by name assigned as alias
QIDCTL80	Fields in a Dictionary	Fields by external field name
QIDCTL81	Formats in a Dictionary	Formats by external format name
QIDCTL82	Files in a Dictionary	Files external file name
QIDCTL86	Files Using a Format	Files using a record format
QIDCTL84	Formats Using a Field	Record formats using a field
QIDCTL88	Files Using a field	Files using a field

Cross-Reference Files

These system-wide cross-reference files are created when the OS/400 program is installed.

File ID	File Purpose	Description
QADBXREF	Cross-reference file (physical)	System database files and links to file definitions
QADBXOWN	Associated logical file	Alternative presentations of data
QADBXDIC	Associated logical file	Alternative presentations of data
QADBXFIL	Associated logical file	Alternative presentations of data
QADBFDEP	Cross-reference dependency (physical)	File-to-file dependency
QADBLDEP	Associated logical file	Alternative presentations of data
QADBLDNC	Associated logical file	Alternative presentations of data

Appendixes

This part provides appendixes that support IDDU users interested in:

- Preparing for IDDU
- Working with a practice exercise
- Gaining an understanding of data and data descriptions on the AS/400 system
- Reviewing a brief presentation of the commands related to IDDU
- Determining the differences between System/36 and the AS/400 system

IDDU users will not use all of the information in these appendixes.

Appendix A. Reviewing File Processing (Preparing for IDDU)

This appendix discusses the different ways manual file processing and computer-based file processing is handled on an AS/400 system, as well as discussing file design considerations.

Current Operations

Before setting up data files in your office, you should review your current file operations. The file processing operations that are discussed here are manual file and computer-based file processing operations on an AS/400 system. The manner of your current operation controls how you should now handle files in your area using the AS/400 system.

Manual File Processing Operations

In some areas, the AS/400 system will be the first system to automate your file processing operations. Currently, you might be making a new telephone list each time someone moves or changes a number by manually retyping it.

Analyze your current manual operations by asking yourself and others the following questions:

- About the input:
 - What information do you want to keep in the system?
 - What source documents (including handwritten notes and telephone memos) do you now use? Where does the information originate?
 - Is any data duplicated in these documents?
 - Is any data supplied regularly?
- About the process:
 - What operations do you need to do for each task?
 - What decisions are necessary?
 - What steps are repeated?
 - What paths does the paperwork follow?
 - How dependent is each process on the completion of the preceding process?
- About the output:
 - What lists, reports, and letters are now being made from the information in the file; and what other types of output could you make from the information in the file? For example, would you like to sort the information into an alphabetic or numeric arrangement, or calculate mathematical results?
 - How often are reports made?
 - To whom are reports distributed?
 - Do any reports or documents contain duplicate information?
 - Is useful information missing from the reports?
 - Can the data be resorted or recalculated quickly?

Computer File Processing Operations

Your office may now share an AS/400 system with another department, which has set up file processing operations. You should analyze your file processing needs and then ask yourself the following questions:

- Are the files available to all who need to use them?
- Is the information you need to do a task contained in one file?
- Is the data arranged in consistent formats that have meaning?
- How often do you change a file (per day, per week, or per month)?

Analyze File Information

It is valuable to conduct a survey of your area regarding the kinds of records and lists you currently keep in your office, if you currently post information for data entry, and if you already supply reports containing data. By analyzing this survey, you should be better able to identify how your users will use data files in reports and documents.

You should also check potential sources of files by talking to the people who work in the area where files are kept. They might be able to supply additional information about how the file is maintained and used.

As you identify existing files, define the various purposes of each file by completing the following steps:

1. Collect and examine the different sample output documents made from a file. When you need to make new reports or letters, sketch a sample to show what information to include and in what sequence.
2. Identify the variable information on each sample document. When the sample document is a list or report, you might find almost the entire output consists of variable information.
3. Mark the fields of the sample document represented by variables.
4. Mark the variables that are a result of calculations using fields in the file; indicate those that are inquiries of the data.
5. List the fields of information currently in the existing file, and for each field:
 - A field name (a maximum of 10 characters) that is descriptive of the data.
 - A field data type: character, numeric, DBCS (double-byte character set), date, time, or timestamp.
 - The maximum possible field length.
 - The number of decimal positions in numeric fields.
 - Any other relevant information about each field, such as:
 - Are the names of states indicated by 2-character abbreviations?
 - Are leading zeros shown; indicated; replaced?
 - How are decimal points indicated?
 - How are credits or negative values indicated?
 - Does a currency symbol appear; where?
 - How are dates and times shown?
 - How each field is used, and any relationships it might have with other fields.

After you have assembled a list of uses and purposes for the potential fields of each file, decide which of these fields should be a part of the file when it is in the system.

- What fields from the information source are used in the proposed output? These need to be fields in the file.
- Is there information in the proposed output that is not the result of calculations? Each of these items should become fields in the file.
- When a field in the information source is not used in the proposed output, where is the information in that field used now? Why is this information included in the existing information source?
 - Locate any output documents you do not have, such as infrequently made letters or reports.
 - Some information in a file, while not used directly as output, is needed to calculate another variable. For example, an employee's year of birth might not be printed in a report, but it might be used to analyze age and eligibility for retirement.
 - The information might not be used at all. For example, information no longer used continues to be followed and kept. However, check with everyone who works with the file because that field might be used by someone you are not aware of. When in doubt, include the information as a field in the file on the system.

Field Design Considerations

Before you define and create the field on your system, some potential problems can be avoided with good file design. Examine the following types of commonly used information:

- Names
- Addresses
- Dates
- Fields containing both characters and numbers (such as part numbers)
- Fields combining more than one kind of information

Name Fields

As you design your file, you might consider a person's full name (first name, middle initial, last name, and title) to be one field of information. However, you should look at how the name will be used in output.

- For example, when you list a field in a query report or in a document, the system prints all the information in the field. Thus, if a person's full name is in one field, the full name will be printed every time that field is used.

When you are sending a person a letter, a salutation such as *Dear Mr. William A. Jones* is awkward. Also, if you are using such a name field to alphabetically sort a list of names, the field will be sorted by the *M*, not by the *J* in *Jones*.

- Remember to include a title field (*Mr.*, *Mrs.*, and so on) in any file in which you have names. The system does not know what title belongs with a name. Unless you have a title field in your file, one solution would be to use one title in the shell document with all names; but that can result in a letter to a Mr. Sally Brown. Another solution would be to include the title with the name, but

that means the salutation would address someone as Dear Miss Sally Brown, never Dear Miss Brown or Dear Sally.

- Include a subtitle field for such attributes as *Jr.* or *III.* The subtitle in the last name field, such as *Brown, Jr.* would print correctly on a mailing list as *Mr. George G. Brown, Jr.*, but in the salutation, would read as *Dear Mr. Brown, Jr.*

Therefore, for maximum versatility, a name field should be broken up into at least five separate fields in the file stored on the system: title, first name, middle name or initial, last name, and subtitle. This arrangement will give you maximum flexibility for using the name in output.

Address Fields

As you design a file, you might put the entire address in one field. However, doing this prevents you from selecting parts of the address or sorting them into a specific order based on information in the address field. You might want to sort your file so that names and addresses appear in order by zip codes. You can do this only if the zip code is in a field by itself. If you want to select all the records for people living in Texas, the state must appear in a separate field.

For maximum flexibility, you should use at least one field for the street or postal address, one field for the city, one field for the state, and one field for the zip or postal code. You might also consider creating a country field.

Date Fields

The following method of handling dates is an alternative to the AS/400 date support; this method may be useful in special situations.

When dates are arranged as YYMMDD, the records sort by year, then by month, then by day. This arrangement should suit most of your needs. However, you might want to print lists such as a monthly birthday list. To do this with the fields arranged by month, then by day without regard to the year, your field would be MMDD or MMDDYY.

To gain the greatest flexibility, separate your data into three fields: year, month, and day. You still type the year as YY, the month as MM, and the day as DD, but each part of the date is in a different field. This allows you to sort or select the fields in any arrangement of year, month, and day for an application using all three fields, or by only month and day for the birthday list.

Using three fields for each date does require more fields, but it is more useful than the YYMMDD design. Generally, if you are not sure about all the possible uses of your file, use one field for dates using the months by name, and one field each for the numeric representation of the year, month, and day. Furthermore, if you define the three date fields as containing numeric data, you have the ability to perform calculations based on these values.

Fields Containing Both Characters and Numbers

Occasionally, inventory numbers, property descriptions, or other items contain both characters and numbers. You must know how this information will be used. If it is to be used for printing or viewing only, it can be contained in one field. However, when the information will be used for sorting or selecting records, you must examine how the information needs to be sorted or selected. For example, in a part number such as AD206, AD might refer to a machine type and 206 to the type

of part. The same part for another machine might be ED206. When these are two separate fields you can create a list by part number (all 206s regardless of the machine type), or of all parts for machine type AD. Remember that even though you might have two fields for the part number, it can be printed so that it appears to be one item.

Combined Fields

If a file will contain a large number of fields, consider a combined field for information that you want to track but not necessarily print. In a combined field, you can use codes for information instead of spelling the information out to compress a number of fields into one field.

For example, instead of designing one field for sex and one field for age, you might define one field and use a code for sex (M for male, and F for female, for example) and a number for age. An entry for a female, age 24, would be F24; a male, age 31, would be entered as M31.

Before you decide to use combined fields in your file, you must consider carefully how the file is to be used. You can still select records using this method. However, your flexibility in sorting is limited. In this example, if you sorted according to the combined sex and age field, the records with females would always appear before males because F sorts before M. It would not be easy to sort the records into order based on age.

In addition, because you cannot easily print part of a field, to print a list of names and ages you would normally have to print the entire field. Instead of printing *Jane Doe, 24*, the system would print *Jane Doe, F24*.

Appendix B. Practice Exercise

The following example shows you how to create the definitions for a name and address file. The definitions are organized to be used with the work you can do in the Data/Text Merge task in *Getting Started with OfficeVision/400* and the data file utility task in *ADTS/400: Data File Utility*.

Assign a file definition name of NAMEADDR and accept the system-assigned record format definition name of NAMEADDRR. The following table provides the rest of the values for you to enter into the various input fields on the IDDU displays:

Field Name	Field Type	Size	Text
LASTNAME	Character	15	Last name
FIRSTNAME	Character	10	First name
ADDRESS1	Character	20	Address line 1
ADDRESS2	Character	20	Address line 2
CITY	Character	15	City
STATE	Character	2	State
ZIP	Character	9	Zip code
AMOUNT	Numeric, 2 decimal positions	6	Amount

1. Go to the IDDU menu by choosing the IDDU option from either the Files menu or the Decision Support menu; or you can type the Start IDDU (STRIDD) command on any command line.
2. Create a data dictionary, unless one exists in a library you can use. If a data dictionary exists that you can use, go to step 7.
3. Choose the Work with Data Dictionary option on the IDDU menu.
4. Choose option 1 (Create) on the new display, type the name of the library that will contain the dictionary, and press the Enter key.
Note: If you attempt to create a data dictionary and the named library does not exist, you will see the Create a Library display. From this display you can create the library that will contain the data dictionary. When you have finished creating a library, you will continue to the Create a Data Dictionary display.
5. On the Create a Data Dictionary display, the name of the library will appear as the name of the dictionary. Later in this exercise, we will use a dictionary name of SYSDIC; you can replace SYSDIC with the name of another dictionary.
6. You can accept the system-supplied values and press the Enter key. You also can type a brief description in the *Text* field and choose to enter a long comment. If you choose option 1 (Select) for the *Long comment* prompt, you will be shown the Edit Long Comment display, where you can type detailed information about the dictionary. The dictionary will be created when you end your work on that display.

The AS/400 system can take some time to create the dictionary; it will advise you with a message when the dictionary has been created. After you create the dictionary, press F12 (Previous) on the Work with Data Dictionary display to return to the IDDU menu.

7. Choose the Work with data definitions option on the IDDU menu and press the Enter key.

```

Interactive Data Definition Utility (IDDU)

Select one of the following:

1. Work with data definitions

```

8. You will name the file definition first, so select option 3 (File).

We have used SYSDIC as an example of a dictionary name; you can replace that name if another is appropriate.

```

Select Definition Type

Type choices, press Enter.

Definition type . . . . . 3      1=Field
                                   2=Record format
                                   3=File

Data dictionary . . . . . SYSDIC  Name, F4 for list

```

Then press the Enter key.

9. When you see the Work with File Definitions display, choose option 1 (Create), and name the new file definition.

We have used NAMEADDR as an example of a file definition name.

```

Work with File Definitions

Dictionary . . . . . : SYSDIC

Position to . . . . . _____ Starting characters

Type options (and File Definition), press Enter.
1=Create 2=Change 3=Copy 4=Delete
6=Print 7=Rename 8=Display where used

File      File      File      File
Opt Definition  Opt Definition  Opt Definition  Opt Definition
1  NAMEADDR

```

Then press the Enter key.

10. When you see the Create a File Definition display, select option 2 (Create single format) and accept the system-supplied name (the system uses the file definition name, but with R as the last letter). You can type brief descriptive information for the *Text* prompt, as we have. The *Long comment* prompt can be left as it appears, or you can type 1 (Select) to enter a detailed description of the definition on the Edit Long Comment display.

```

                                Create File Definition
Definition . . . . . : NAMEADDR          Dictionary . . . . . : SYSDIC
Type choices, press Enter.

Record formats
option . . . . . 2          1=Create and/or select formats
                             2=Create default format
                             and select fields

For choice 2=Create default format:
Format . . . . . NAMEADDR Name

Select key field
sequence . . . . . N          Y=Yes, N=No

Long comment . . . . . _          1=Select, 4=Remove

Text . . . . . Practice definition for DFU and QUERY

F3=Exit  F12=Cancel

```

Then press the Enter key.

11. You are now ready to begin creating the field definitions that will be used by the record format definition you just named. Name the first field definition you will create for the record format definition on the Create and Select Field Definitions display. Use the system-supplied sequence number on the display.

```

                                Create and Select Field Definitions
Definition. . . . . : NAMEADDRR          Dictionary. . . . . : SYSDIC
Position to . . . . . _____ Field, sequence (0-99999)
Type sequence numbers (0-99999), (and field), press Enter.
Type field, press F6 to create.

Seq   Field      End   Seq   Field      End   Seq   Field      End
10    LASTNAME    15

```

Then press F6 (Create field definition). You will complete the description of this first field definition, as well as name and describe the remaining field definitions, using the next display.

12. Complete the first description with its type, size, and any other characteristics, and then name and describe the remaining field definitions.

```

                                Create Field Definitions

Type information, press Enter to create.
Field type (size) . . . : 1=Character (1-32766)
                        2=Numeric (1-31, decimal positions 0-31)
                        3=DBCS (4-32766, mixed; 1-16383, graphic)
                        4=Date/Time (no size)
More options. . . . . : Y=Yes

-----Field----- Dec More
Name      Type Size  Pos  Opts  Text
-----
LASTNAME   1  15   --   --   Last name
FIRSTNAME  1  10   --   --   First name
ADDRESS1   1  20   --   --   Address line 1
ADDRESS2   1  20   --   --   Address line 2
CITY       1  15   --   --   City
STATE      1   2   --   --   State
ZIP        1   9   --   --   Zip code
AMOUNT     2   6   2   --   Amount

```

For numeric fields, you have to specify the number of decimal positions.

- When you have completed specifying the field characteristics, press the Enter key; the fields are created. The Create Field Definitions display is shown again, which allows you to specify more fields. If you do not want to specify more fields, press the Enter key without making any changes to the display.

```

                                Create Field Definitions

Type information, press Enter to create.
Field type (size) . . . : 1=Character (1-32766)
                        2=Numeric (1-31, decimal positions 0-31)
                        3=DBCS (4-32766, mixed; 1-16383, graphic)
                        4=Date/Time (no size)
More options. . . . . : Y=Yes

-----Field----- Dec More
Name      Type Size  Pos  Opt  Text
-----
_____  -  _____  -  -  _____
_____  -  _____  -  -  _____
_____  -  _____  -  -  _____

```

- When you see the Create and Select Field Definitions display, verify that the field names are arranged in the proper sequence.

```

                                Create and Select Field Definitions

Definition.....: NAMEADDR      Dictionary.....: SYSDIC

Position to . . . . . _____ Field, Sequence (0-99999)

Type sequence numbers (0-99999), (and field), press Enter.
Press F6 to create.

Seq  Field      End   Seq  Field      End   Seq  Field      End
10   LASTNAME    15
10   FIRSTNAME   25
10   ADDRESS1    45
10   ADDRESS2    65
10   CITY        80
10   STATE       82
10   ZIP         91
10   AMOUNT     95

```

(When sequence numbers are the same, the arrangement of the field names on the display determines the sequence of use in the record.) If a field is out of sequence, type the necessary sequence numbers to indicate the correct arrangement, and press the Enter key. When the fields are in the proper sequence, press the Enter key without making any changes to the display.

15. You will then see the Work with File Definitions display, where you press F3 (Exit) without making any changes to the display.

```

                                Work with File Definitions
Dictionary . . . . . : SYSDIC
Position to . . . . . _____ Starting characters
Type options (and File Definition), press Enter.
  1=Create  2=Change  3=Copy  4=Delete
  6=Print  7=Rename  8=Display where used

  File      File      File      File
Opt  Definition  Opt  Definition  Opt  Definition  Opt  Definition
-   NAMEADDR    -   XXXXXXXXXX  -   XXXXXXXXXX  -   XXXXXXXXXX
-   XXXXXXXXXX  -   XXXXXXXXXX  -   XXXXXXXXXX  -   XXXXXXXXXX
-   XXXXXXXXXX  -   XXXXXXXXXX  -   XXXXXXXXXX  -   XXXXXXXXXX
-   XXXXXXXXXX  -   XXXXXXXXXX  -   XXXXXXXXXX  -   XXXXXXXXXX
-   XXXXXXXXXX  -   XXXXXXXXXX  -   XXXXXXXXXX  -   XXXXXXXXXX
-   XXXXXXXXXX  -   XXXXXXXXXX  -   XXXXXXXXXX  -   XXXXXXXXXX
-   XXXXXXXXXX  -   XXXXXXXXXX  -   XXXXXXXXXX  -   XXXXXXXXXX
                                     More ...
F3=Exit      F5=Refresh   F10=Work with database files
F11=Display text  F12=Cancel  F22=Work with data dictionaries

```

You are finished creating the definitions describing a database file. The instructions to create the file and to enter data into the file are in Chapter 8, "Working with Database Files."

Appendix C. Data Descriptions on the AS/400 System

This chapter discusses the ways that database files are described on the AS/400 system.

Describing Data on the AS/400 System

Two methods of describing data on the AS/400 system are the data description specifications (DDS) and the interactive data definition utility (IDDU). Data descriptions are created using DDS, and data definitions are created using IDDU. These methods are summarized in the following paragraphs.

Data Descriptions

You can use DDS to describe how the data is organized. The system saves these descriptions with the file when it is created (using, for example, the Create Physical File (CRTPF) command).

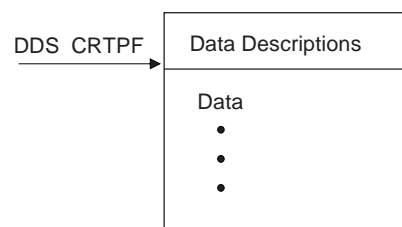

RSSL479-0

DDS allows you to define database files on the AS/400 system. You might have to use this method to use all of the AS/400 database features. For more information see *DB2 for AS/400 Database Programming*.

The descriptions of some DDS-created files can be added to a dictionary. For information on this, see "Creating Definitions from Files" on page 14-1.

Data Definitions

You can create field, record format, and file definitions with IDDU. The system stores them in a data dictionary. These data definitions are associated with the file when the file is created using IDDU.

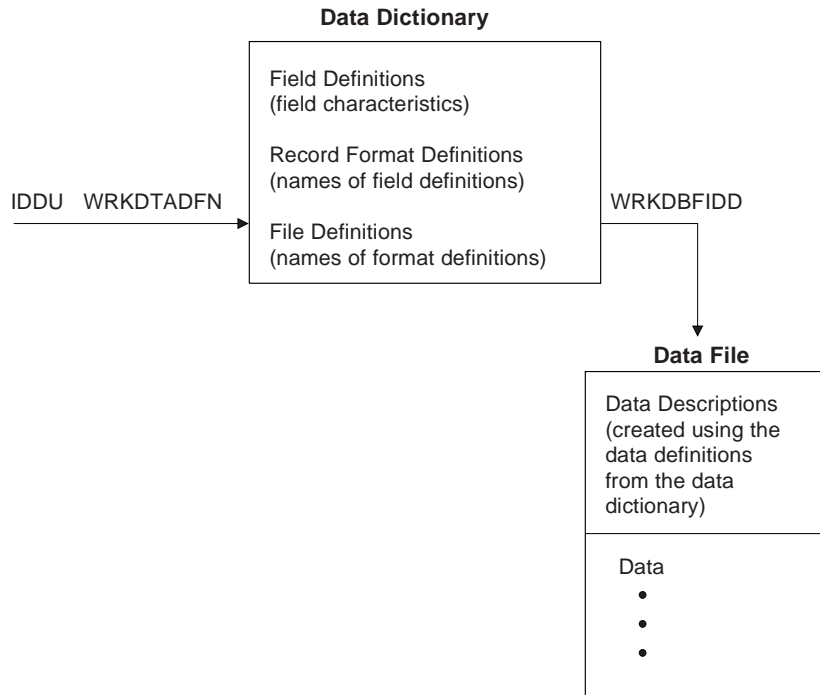

RSL477-0

Dictionary Descriptions

Dictionary descriptions have the definitions of the file, its format, and the fields used by the format described once in a data dictionary and have these definitions used by many programs for many purposes. It is necessary to describe all the fields only once, and then organize those fields in different ways, using different record formats, for differing file uses.

The definitions in a data dictionary will create either program-described or externally described files. See “Program-Described Files” and “Externally Described Files” for a discussion of these methods of database file description. When a file is created using IDDU and only a single record format definition exists in the file definition, an externally described file is created and a copy of the dictionary file definition is stored with the file. A program-described file is created with no copy of the file definition in the file under the following conditions:

- When more than one record format definition exists for a file description
- When a record format contains record ID codes
- When a file name has an authority level assigned (authority holder)

In all cases, the file and the dictionary definitions are linked during creation. The following figure illustrates this relationship.

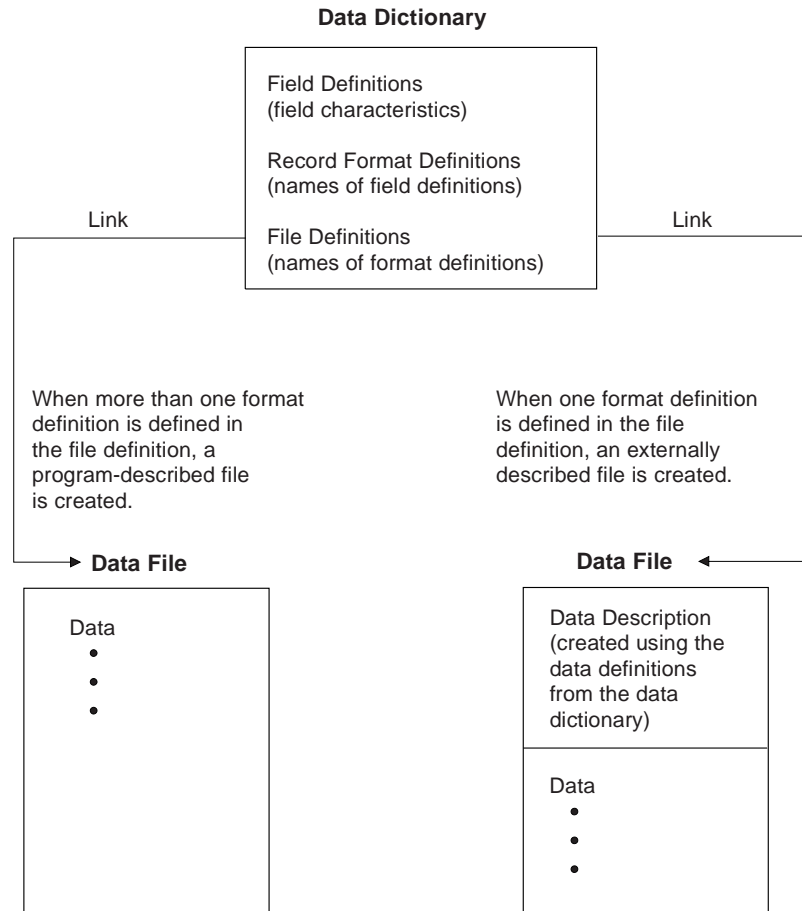

RSL476-1

Database Files on the AS/400 System

A database is a collection of data files in the system. They are described together in one place using a common method of description that allows them to be used by more than one program. Individual data files thus described are sometimes also called **database files**.

The AS/400 database manager supports both program-described database files and externally described database files. IDDU can be used to create either program-described files or externally described files. DDS can also be used to create externally described files.

Files and Members

Every file on the AS/400 system that contains any data has at least one member, but a file can contain several members, all having the same record format. For example, a file might have a separate member for each month in the year. Each member in a file has the same file, record format, and field definitions.

All files created by IDDU will have one member that has the same name as the file. If you do not use CL commands to add additional members to the file, then you can use that file name when you enter data into the file or query the file.

When you use the Add Data Definition (ADDDTADFN) command to create the definitions, those definitions are associated with the file and not with individual members in the file. This means that when you link a definition to a file, all members of the file will have the same definition.

Program-Described Files

Program-described files are database files that do not have the data descriptions stored with the file. This means that some programs, such as Query/400, cannot use these files without a method of determining the format of the file. (IDDU is such a method.) Application programs written in a “high-level” programming language, such as RPG or COBOL, use program statements to describe the files and data they use. These files are called **program-described files**. The database file and its data descriptions are known to the program in which the descriptions are contained; they cannot be used by any other program on the system. Each program that refers to a database file must contain its own set of data descriptions.

Considerations limiting the usefulness of program-described files include:

- Query can not use a program described file as it fits this description. Query and similar programs can only work with a database file that has data descriptions either within the file (externally described), or if they are linked to a file definition in a data dictionary.
- High-level languages (such as RPG III) supporting externally described files can not easily support program-described files.
- Descriptions of program-described files are not saved when the files are saved.

Externally Described Files

Externally described files have their data descriptions stored with the file. This means that some applications, such as control language (CL) programs or queries, only name the file they want to use; the system finds the related data descriptions. These are called **externally described files** because they are described outside of the application program. In contrast to program-described files, externally described files can be used by *any* application (query, document, CL program) that accepts data described in that manner. The files described earlier in this appendix as created from both DDS and IDDU descriptions are externally described.

Refer to the applicable programming language book for information on using externally described files with that language.

Appendix D. IDDU Commands

This appendix describes the IDDU commands and lists their parameters. Press F4 (Prompt) when you enter these commands to be prompted to enter values for the parameters. Refer to the *CL Reference* for detailed information about all AS/400 commands.

- ADDDTADFN (Add a Data Definition)

Adds definitions for files, record formats, and fields from an externally described database file to a data dictionary. You are prompted to enter values for these items:

file name, library name, dictionary name, definition name

The definition name is optional; the file name is used if no other is specified.

The ADDDTADFN command also creates a link between the file and the definition. If you use the command again with the same file, the first link is dropped and the file is linked to the new definition.

Note: Matching definitions already in the data dictionary will be used again. If existing definitions have matching names but the attributes (including text and long comment) are not identical, a new version of the definitions will be created and inserted into the data dictionary.

- CRTDTADCT (Create a Data Dictionary)

Creates a data dictionary. You are prompted to enter values for these items:

dictionary name, authority, text

The dictionary name is required; the other parameters are optional. A library with the same name as the dictionary must already exist.

- DLTDADCT (Delete a Data Dictionary)

Deletes a data dictionary. You are prompted to enter the dictionary name.

- DSPDTADCT (Display Data Dictionary)

Prints contents of a field, record format, or file definition. You are prompted to enter values for these items:

dictionary name, definition name, creation date,
definition type, output, level of file information,
level of record format information, level of field information

The dictionary name is required; the other parameters are optional.

- LNKDTADFN (Link Data Definition)

Links or unlinks file definitions and program-described database files. You are prompted to enter values for these items:

option, file name, dictionary name, file definition

The option (LINK or UNLINK) and file name parameters are required. Dictionary name and file definition name are required when linking, optional when unlinking.

- RSTLIB (Restore Library)

Restores to the system all user libraries that were saved by the Save Library (SAVLIB) command. Required parameters are determined by the task. You are prompted to enter values for these items:

savlib saved library, device, volume ID, sequence number, label, end operation, starting library, save file name, option, member option, save date, save time, allow object differences, restore library, restore auxiliary storage pool, output

- SAVLIB (Save Library)

Saves a copy of up to 50 specified libraries. Required parameters are determined by the task. You are prompted to enter values for these items:

savlib library, device, volume ID, sequence number, label, expiration date, end operation, starting library, save file name, update history, target release, clear, precheck, access paths, save file/data, storage, data compression, compaction, omit libraries

- STRIDD (Start Interactive Data Definition)

Shows the IDDU menu display, where you can select to work with data dictionaries, definitions, or files; and use IDDU commands or office procedures. You do not have to specify any values for this command.

- WRKDBFIDD (Work with Database Files using IDDU)

Shows the Work with Database Files display, where you can select either to create physical files or to enter and update file data. You are prompted to enter a value for library. This parameter is optional.

- WRKDTADCT (Work with Data Dictionaries)

Shows the Work with Data Dictionaries display, where you can choose to create, change, delete, and print the contents of a data dictionary. You do not have to specify any values for this command.

- WRKDTADFN (Work with Data Definitions)

Shows the Select Definition Type display, where you can select the definition type to create, change, copy, delete, print, rename, or display where-used information. You are prompted to enter values for these items:

data dictionary, definition type

These parameters are optional.

Appendix E. Differences between IDDU on the AS/400 System and System/36

This appendix describes the differences between IDDU on the AS/400 system and System/36. The IDDU differences described in this appendix are limited to those that could cause you some inconvenience if you do not know about them before working with IDDU. This appendix defines these differences as:

- Conceptual
- Operational
- Command

Conceptual Differences

The following list identifies the concept that is different on the AS/400 system along with an explanation of the differences as it applies to the listed concept:

Concept	Differences
Folders	On System/36, a data dictionary was stored in a folder. On the AS/400 system, a data dictionary is stored in a library. You can only have one data dictionary specified per library. Both the data dictionary and the library have the same name.
#USRDCT	The data dictionary name #USRDCT was automatically created and used as a default dictionary on System/36. If you require a dictionary named #USRDCT on the AS/400 system, you must create it on your AS/400 system.
Communications files	Definitions for communication files are not stored in data dictionaries on the AS/400 system as they were on System/36. You must use DDS to define intersystem communications function (ICF) files on the AS/400 system.
Filler fields	On System/36, filler fields did not have to be named. On the AS/400 system, filler fields must be named; they show up when you define your queries.
Linking files	On the AS/400 system, date-differentiated files are stored as members in the same file. Therefore, all date-differentiated files must be linked to the same definition.

Operational Differences

The following list identifies the operation that is different on the AS/400 system along with an explanation of the differences as it applies to the listed operation:

Operation	Differences
Changing definitions	On the AS/400 system, you cannot change a long comment, text, and editing comments when the file is linked, as you could on System/36.
ANK/IGC Either	On System/36, you could use either ANK Either or IGC Either. On the AS/400 system, you can only use ANK Either.

Default data type	On the AS/400 system, the default numeric data type is packed. On System/36, the default numeric data type is zoned.
Link, unlink	On the AS/400 system, the link and unlink operations are only available with the Link Data Definition (LNKDTADFN) command, Add Data Definition (ADDDTADFN) command, or the IDDULINK procedure. On System/36, these operations are also available on an interactive display.

Command Differences

The following table lists the System/36 data dictionary commands and the equivalent AS/400 commands (if appropriate) plus some system commands that work with data dictionaries:

System/36	AS/400 System
IDDU	STRIDD
IDDUDCT	WRKDTADCT
IDDUDFN	WRKDTADFN
IDDUDISK	WRKDBFIDD
IDDULINK	LNKDTADFN
IDDUPRT	DSPDTADCT
IDDURBLD	Not required
IDDUXLAT ¹	Not supported
DELETE ¹	DLTDTADCT
SAVEFLDR ¹	SAVLIB
RESTFLDR ¹	RSTLIB (or RSTS36FLR ²)
RENAME ¹	RSTLIB to different library
No equivalent	ADDDTADFN (new)
No equivalent	CRTDTADCT (new)

¹ These IDDU commands do not work within the AS/400 System/36 environment.

² Restores a dictionary saved on a System/36 using the SAVEFLDR command.

Bibliography

You might need to review some or all of the following manuals before or while you are using this manual. Except where otherwise indicated, each is an AS/400 system manual.

The manuals below are listed with their full title and base order number.

- *Backup and Recovery*, SC41-5304, describes the basic backup and recovery features of the AS/400 system.
- *Backup and Recovery*, SC41-5304, describes the advanced backup and recovery features of the AS/400 system.
- *DDS Reference*, SC41-5712, describes the data description specifications (DDS).
- *Data Management*, SC41-5710, describes the data management tools of the AS/400 system, including the Copy File (CPYF) command.
- *DB2 for AS/400 Database Programming*, SC41-5701, describes how to set up and use a database system on the AS/400 system.
- *National Language Support*, SC41-5101, prepares the AS/400 user for planning and using the national language support (NLS) and the multilingual support of the AS/400 system. It also provides an explanation of the database management of multilingual data and application considerations for a multilingual system.
- *System Operation for New Users*, SC41-3200, describes using display stations on the AS/400 system.
- *CL Reference*, SC41-5722, describes the AS/400 control language commands. *National Language Support*, SC41-5101
- *Query/400 Use*, SC41-5210, describes the Query/400 utility.
- *Security – Basic*, SC41-5301, describes the basic security features of the AS/400 system.
- *Security – Reference*, SC41-5302, describes the integrated security features of the AS/400 system.
- SH21-0732, provides a method for learning to use the word processing functions of the AS/400 system.
- SH21-0699, describes installing and setting up your AS/400 system.
- SH21-0701, describes the AS/400 word processing capabilities.
- *DB2 for AS/400 SQL Programming*, SC41-5611, describes programming and using the AS/400 Structured Query Language (SQL).
- *DB2 for AS/400 SQL Reference*, SC41-5612, describes AS/400 Structured Query Language (SQL) statements.

Index

A

accessing

- controlling 4-2
- data dictionary
 - changing 13-1
- dictionary rights 4-2

add data definition command 14-1

ADDDTADFN (Add Data Definition command) D-1

alias 7-7, 9-4

allocated length 7-10

alphabetic only character shift 9-4

alphanumeric character shift 9-4

alternative name 7-7, 9-4

analyzing file information A-2

AS/400 IDDU

- See IDDU

authority

- assigning access 4-2
- changing access, dictionaries 13-1
- Create Data Dictionary prompt 4-2
- data dictionary 4-2
- generic levels 15-1
- requirements
 - for IDDU operations 15-1
 - non-IDDU dictionary operations 15-2
- rights
 - dictionary 4-2
 - table 15-2

B

binary data 7-8

bracketed-DBCS data

- See double-byte character set (DBCS)

C

changing

- data dictionaries 13-1
- definitions 12-1
- dictionary authority 13-1
- dictionary descriptions 13-1
- field definition 12-3
- file definitions 12-2
- file key attributes 11-2
- key field sequence attributes 11-3
- linked definitions 14-2
- linked dictionary definitions 14-3
- record format definition 12-2

character

- data type 7-9
- field A-4

character (*continued*)

- keyboard shift 9-4

character field

- additional characteristics 7-9
- data type 7-9

Character Field Options display 3-5

column heading 7-6

command

- ADDDTADFN (IDDU) D-1
- CRTDTADCT (IDDU) D-1
- DLTDTADCT (IDDU) D-1
- DSPDTADCT (IDDU) D-1
- LNKDTADFN (IDDU) D-1
- RSTLIB D-1
- SAVLIB D-2
- STRIDD (IDDU) D-2
- WRKDBFIDD (IDDU) D-2
- WRKDTADCT (IDDU) D-2
- WRKDTADFN (IDDU) D-2

comment

- long
 - dictionary 4-3
 - field definition 7-7
 - file definition 5-4
 - record format definition 6-4

computer file processing A-2

concept

- field 1-2
- file 1-1, 1-2
- file processing 1-3
- maintaining data 1-5
- querying data 1-4
- record 1-2

Confirm Copy display 12-5

Confirm Delete of ... Definition display (example) 12-6

Confirm Delete of Data Dictionary display 13-2

confirming definition

- copy 12-5
- delete 12-6

consideration

- adding file definitions 14-2
- address fields A-4
- assigning authority to dictionary 4-2
- character and number fields A-4
- combined fields A-5
- describing dictionary 4-2
- field design A-3
- field names A-3
- limited usefulness of program-described files C-4
- linking files 14-1
- multiple record formats 5-3

consideration *(continued)*

- record format 10-1
- securing dictionary 4-2
- sequence of fields in a record 6-3
- SQL and IDDU 13-4

content

- dictionary files 16-1

controlling

- dictionary access 4-2

Copy ... Definition display (example) 12-4**copy confirm**

- field definition 12-5
- file definition 12-5
- record format definition 12-5

copying

- data definition 12-4
- data dictionaries 13-4

Create a Database File display 8-1**Create and Select Field Definitions display**

- creating field definitions 6-6
- practice exercise B-3
- selecting field definitions 5-7

Create and Select Record Formats display 5-8**Create Data Dictionary display 4-2****Create Field Definitions display**

- create field definitions 7-12
- practice exercise B-3

Create File Definition display

- create file definition 5-5
- practice exercise B-2

Create Record Format Definition display 6-5**creating**

- data definitions 14-1
- data dictionary 4-1
- database file 8-1
- field definition 7-12
- file definition 5-5
- record format definition 5-7, 6-4

cross-reference files

- dictionary 16-2
- file-to-file 16-2
- files 16-2

CRTDTADCT (Create Data Dictionary command) D-1**current file operations A-1****D****data**

- describing C-1
- queries and documents 2-7

data definition

- adding 14-1
- copy confirm 12-5
- copying 12-4
- creating
 - data 14-1

data definition *(continued)*

- delete confirm 12-6
- description 2-2
- link and unlink files 14-1
- maintaining 12-1
- printing 12-6
- renaming 12-10
- where used 12-10
- work with 12-1

data description C-1**data dictionary**

- advantages 2-2
- authority 4-2
- changing 13-1
- contents
 - viewing 13-3
- copy 13-4
- creating 4-1
- deleting 13-2
- describing 4-3
- duplicating 13-4
- library for 4-1
- maintaining 13-1
- printing/displaying contents 13-2
- recovering 13-3
- renaming 13-4
- restoring 13-3
- saving 13-3
- securing 4-2
- tasks 4-3
- viewing
 - contents 13-3

data type

- character (SBCS) 7-9
- hexadecimal 7-9

database files

- creating 8-1
- definitions
 - creating 14-1
 - supported by IDDU 14-1
- securing 8-2

date format 7-10**date separator 7-11****date/time fields**

- data type 9-8
- editing 7-10

date/time/timestamp 7-10**DBCS**

See double-byte character set (DBCS)

DBCS Field Options display 9-7**DDS file definition**

- data description C-1
- specifications C-1

defining

- sequence of fields 6-3

definition

- changing
 - file, when linked 14-3
 - record format 12-2
- created by
 - IDDU 13-5
 - SQL 13-5
 - SQL compared to IDDU 13-5
- creating 14-1
 - field 7-12
 - file 5-5
 - record format 5-7, 6-4
- data
 - adding 14-1
 - copy confirm 12-5
 - copying 12-4
- database file 14-1
- DDS C-1
- deleting 12-6
- field
 - changing 12-3
 - creating 7-12
 - planning 7-1
 - work with 7-14
- file change 12-2
- files
 - linking and unlinking 14-1
- linked 14-2
- maintaining 12-1
- missing database file 14-2
- name
 - field 7-5
 - file 5-3
 - position to 5-8
 - record format 5-3
- printing 12-6
- record format
 - changing 12-2
 - work with 6-7
- renaming 12-10
- where used 12-10, 12-11
- work with 12-1

deleting

- data definition 12-6
- data dictionaries 13-2
- SQL definition 13-5

Describe Numeric Field Editing display 7-13**describing data C-1****description**

- data C-2
- database files C-3
- dictionary C-2
- dictionary files 16-1
- files
 - externally described C-4
 - program linked C-4
 - program-described C-4

description (continued)

- long comment 5-4, 6-4, 7-7
- text, dictionary 4-3

dictionary

- authority 4-2
- changing 13-1
- considerations
 - assigning authority 4-2
 - securing 4-2
- contents
 - viewing 13-3
- controlling access 4-2
- copying 13-4
- creating 4-1
 - authority 4-2
- cross-reference files 16-2
- definition
 - changing when linked 14-3
- deleting 13-2
- describing 4-3
- descriptions C-2
- displaying
 - contents 13-3
- file contents 16-1
- maintaining 13-1
- name 4-1
- printing
 - contents 13-2
- recovering 13-3
- renaming 13-4
- restoring 13-3
- rights 4-2
- saving 13-3
- sharing SQL and IDDU 13-4
- viewing
 - contents 13-3

dictionary operation 15-2**digits only**

- character shift 9-4
- numeric shift 9-6

directory

- dictionary files 16-1

display

- Character Field Options 3-5
- Confirm Copy 12-5
- Confirm Delete of ... Definition (example) 12-6
- Confirm Delete of Data Dictionary 13-2
- Copy ... Definition (example) 12-4
- Create a Data Dictionary 4-1
- Create a Database File 8-1
- Create and Select Field Definitions B-4
- Create and Select Record Formats 5-8
- Create Field Definitions 7-12, B-3, B-4
- Create File Definition 5-5, B-2
- Create Record Format Definition 6-5
- Creating Field Definitions 6-6

display *(continued)*

- Describe Numeric Field Editing 7-13
- Editing a Long Comment 4-3
- End ... Definition (example) 12-1
- Field Options 7-13
- IDDU Main (system) Menu B-1
- list example 2-5
- Print Options 12-6, 13-2
- Select Definition Type 2-5, 5-5, 6-4, 7-12, B-2
- Selecting Field Definitions 5-7
- Specify Edit Code 9-1
- Specify Edit Word 9-3
- Work with ... Definitions (example) 12-1
- Work with Data Dictionaries 4-1, 13-1
- Work with Database Files 8-1
- Work with Field Definitions 7-12
- Work with File Definitions 3-2, 3-3, 3-4, 5-5, B-2, B-5
- Work with Record Format Definitions 6-4

displaying

- data definitions 12-6
- data dictionary contents 12-6

DLTDTADCT (Delete Data Dictionary command) D-1

document

- merging data A-1

double-byte character set (DBCS)

- additional characteristics 7-9
- data types 7-9
- defining 7-5

DSPDTADCT (Display Data Dictionary command) D-1

duplicating

- data dictionaries 13-4

E

edit code (EDTCDE)

- description 9-1
- parameters 9-1
- table 9-2

edit word 9-3

editing

- fields 9-1
- numeric fields 7-8, 9-3
- techniques 9-1

Editing a Long Comment display 4-3

EDTCDE (edit code)

- description 9-1
- parameters 9-1
- table 9-2

End ... Definition display example 12-1

exercise

- practice example B-1

externally described files C-4

F

field

- additional characteristics
 - numeric fields 7-8
- allocated length 7-10
- basic characteristics 7-5
- column headings 7-6
- concepts 1-2
- data type 7-5
- defining key 11-1
- design considerations A-3
- editing
 - date/time 7-10
- in a record
 - considerations 6-3
- key 11-1
- name A-3
- null attribute 7-7
- size 7-5

field definition

- changing 12-3
- character 7-9
- column headings 7-6
- copy confirm 12-5
- copying 12-4
- creating 7-12
- DBCS 7-9
- delete confirm 12-6
- deleting 12-6
- description 2-3
- design considerations
 - address fields A-4
 - character and number fields A-4
 - combined fields A-5
 - name fields A-3
- field type 7-5
- grouping 2-4
- long comment, text 7-7
- name 7-5
- null attribute 7-7
- planning 7-1
- renaming 12-10
- size 7-5
- where used 12-11
- work sheet 7-4
- work with 7-14

field described files

- externally described C-4

Field Options display 7-13

file

- concepts 1-1, 1-2
- creating the database 8-1
- cross-reference 16-2
- database C-3
- dictionary
 - cross-reference 16-2

file (*continued*)
 dictionary (*continued*)
 description 16-1
 externally described (program linked) C-4
 field described (program linked) C-4
 file-to-file cross-reference 16-2
 keyed 11-1
 limited usefulness of program-described C-4
 linking, unlinking definitions 14-1
 members C-3
 not dictionary described C-1
 program linked (externally described) C-4
 program-described 14-2
 work with database file 8-1

file definition

change 12-2
 copy 12-5
 copy confirm 12-5
 copying 12-4
 create a record format 5-7
 creating 5-5, 14-1
 DDS C-1
 delete confirm 12-6
 deleting 12-6
 description 2-3
 keyed file 11-1
 long comment, text 5-4
 missing database 14-2
 name 5-3
 renaming 12-10
 select new record formats 5-8
 using key fields
 changing 11-1
 creating 11-1
 where used 12-10, 12-11
 working with 3-2, 3-3, 5-5, 5-9

File Definitions display 3-3, 3-4

file key attribute

changing 11-2
 duplicate key values 11-2
 key order 11-2

file operations

current A-1

file processing

analyzing file information A-2
 computer A-2
 concepts 1-3
 creating a file definition 5-5
 field design considerations A-3
 manual A-1
 record ID codes 10-1

file-to-file cross-reference 16-2

floating point data 7-6, 7-8

format

create record format for a file definition 5-7
 select for a file definition 5-8

function key 3-2

G

generic authority level 15-1

getting started 3-1

graphic field

 DBCS field options 9-7
 defining 7-5

guideline for name field A-3

H

hexadecimal data 7-9

hexadecimal data type 9-4

I

IDDU

capabilities 2-7
 compared to SQL 13-5
 definitions used by SQL 13-5
 differences (from System/36) E-1
 features 2-5
 main (system) menu 3-1, B-1
 options
 IDDU menu 3-1
 main (system) menu 3-1, B-1
 SQL 13-4—13-5
 support database file definitions 14-1
 terminology used by SQL 13-4
 unsupported SQL files 13-5

IDDU operation

 authority requirements 15-1

interrupted session

 recovering 12-11
 resuming 12-11

K

key

 function 3-2

key field definition 5-4

key field sequence

 changing 11-1
 changing attributes
 order 11-3
 value 11-3
 selecting 11-1

keyboard shift

 character 9-4
 DBCS 9-7
 numeric 9-6

L

level of authority

- data dictionary 4-2
- generic 15-2

library for data dictionary 4-1

link data definition and file 14-1

linked definition

- changing 14-2

linked files

- externally described C-4

list

- using 3-3

list display

- example 2-5

listing

- data definitions 12-6
- data dictionary contents 12-6

LNKDTADFN (Link Data Definition) command D-1

long comment

- dictionary 4-3
- field definition 7-7
- file definition 5-4
- record format definition 6-4

M

maintaining

- data concepts 1-5
- data dictionaries 13-1
- definitions 12-1

manual file processing A-1

members and file C-3

menu

- IDDU options 3-1
- main menu options 3-1, B-1

missing database file definition 14-2

multiple record format 5-3

N

name

- alias 7-7, 9-4
- alternative 7-7, 9-4
- dictionary 4-1
- field A-3
- field definition 7-5
- file definition 5-3
- position to 5-8
- record format definition 5-3, 6-3

new definition, field 7-12

non-IDDU authority requirement 15-2

nondictionary described file C-1

null attribute 7-7

number field A-4

numeric

- character shift 9-4, 9-6
- keyboard shift 9-6
- numeric shift 9-6

numeric field

- additional characteristics 7-8
- data type 7-8
- decimal positions 7-6
- edit word 9-3
- editing 7-8

O

office security, resource 4-2

operation

- authority requirements
 - IDDU 15-1
 - non-IDDU dictionary 15-2
- current file A-1
- manual file processing A-1

option

- choosing 3-2
 - multiple 3-4
- IDDU menu 3-1
- Main IDDU (system) Menu 3-1, B-1

P

packed data 7-8

position to sequence number 5-8

practice exercise B-1

print options display 12-6, 13-2

printing

- data definitions 12-6
- data dictionary contents 12-6, 13-2

processing files

- computer A-2
- design considerations A-3
- manually A-1
- reports, documents A-1

processing operation A-1

program linked files (externally described) C-4

program-described file 14-2, C-4

Q

querying data concepts 1-4

R

record concept 1-2

record format

- changing 12-2
- considerations 10-1
- create 5-7
- create format for a file definition 5-7
- defining 6-1

record format *(continued)*
 definition 12-2
 displaying 12-6
 name
 position to 5-8
 sequencing 5-8
 naming rules 6-3
 number
 position to 5-8
 sequencing 5-8
 printing 12-6
 select for a file definition 5-8

record format definition
 considerations for sequence of fields 6-3
 copy 12-5
 copy confirm 12-5
 copying 12-4
 create 6-4
 delete confirm 12-6
 deleting 12-6
 description 2-3
 long comment, text 6-4
 multiple record formats 5-3
 name 5-3
 naming rules 6-3
 planning 6-1
 record ID codes 10-1
 renaming 12-10
 where used 12-11
 work sheet 6-2
 work with 6-7

record format name, position to 5-8

record ID codes 10-1

recovering
 dictionaries 13-3
 interrupted session 12-11

removing
 data definition 12-6
 data dictionaries 13-2
 definition 12-6

renaming
 data definition 12-10
 data dictionaries 13-4

reports A-1

requirement
 authority
 for IDDU operations 15-1
 for non-IDDU dictionary operations 15-2

resource and office security 4-2

restoring
 data dictionaries 13-3

rights, controlling dictionary access 4-2

rights/authority table 15-2

RSTLIB (Restore Library) command D-1

S

same dictionary, SQL and IDDU 13-4

saving
 data dictionaries 13-3

SAVLIB (Save Library) command D-2

SBCS
 See single-byte character set

securing data dictionaries 4-2

security
 changing data dictionaries 13-1
 data dictionary 4-2
 resource and office 4-2

select
 new record formats 5-8

select definition type
 field 7-12
 practice exercise B-2
 record format 6-4

Select Definition Type display 5-5, 6-4, 7-12, B-2

Select Key Fields display 11-3

separator
 date 7-11
 options 9-8
 time 7-11

sequence number, position to 5-8

session, resuming interrupted 12-11

sharing a dictionary, SQL and IDDU 13-4

shift keyboard
 character 9-4
 DBCS 9-7
 numeric 9-6

signed numeric shift 9-6

single-byte character set (SBCS) 7-5, 9-8

specify
 character keyboard shift 9-7
 date/time options 9-8
 DBCS data type 9-7
 edit code 9-1
 numeric keyboard shift 9-6
 separator options 9-8

Specify Edit Word display 9-3

SQL
 compared to IDDU 13-5
 delete definition 13-5
 not supported by IDDU 13-5
 terminology used by IDDU 13-4
 use IDDU definitions 13-5

starting IDDU 3-1

STRIDD (Start IDDU) command D-2

System/36-AS/400 differences E-1

T

table authority/right 15-2

task, data dictionary 4-3

text (description)

dictionary 4-3

field definition 7-7

file definition 5-4

record format definition 6-4

time format 7-11

time separator 7-11

U

unlink data definition and file 14-1

V

viewing a data dictionary 13-3

W

Work with ... Definitions (example) 12-1

Work with Data Dictionaries display 4-1, 13-1

Work with Database Files display 8-1

Work with Field Definitions display 7-12

Work with File Definitions display 3-2, 3-3, 3-4, 5-5,
B-2, B-5

Work with Record Format Definitions display 6-4

working with

data dictionary 4-3

database files 8-1

definitions 12-1

dictionary

access rights 4-2

authority 4-2

field definitions 7-14

file definitions 5-9

nondictionary described files C-1

record format definitions 6-7

WRKDBFIDD (Work with Database Files)

command D-2

WRKDTADCT (Work with Data Dictionaries)

command D-2

WRKDTADFN (Work with Data Definitions)

command D-2

Z

zoned data 7-8

Reader Comments—We'd Like to Hear from You!

AS/400 Advanced Series

IDDU Use

Version 4

Publication No. SC41-5704-00

Overall, how would you rate this manual?

	Very Satisfied	Satisfied	Dissatisfied	Very Dissatisfied
Overall satisfaction				

How satisfied are you that the information in this manual is:

Accurate				
Complete				
Easy to find				
Easy to understand				
Well organized				
Applicable to your tasks				

THANK YOU!

Please tell us how we can improve this manual:

May we contact you to discuss your responses? Yes No

Phone: (____) _____ Fax: (____) _____ Internet: _____

To return this form:

- Mail it
- Fax it
 - United States and Canada: **800+937-3430**
 - Other countries: **(+1)+507+253-5192**
- Hand it to your IBM representative.

Note that IBM may use or distribute the responses to this form without obligation.

Name

Address

Company or Organization

Phone No.



Fold and Tape

Please do not staple

Fold and Tape

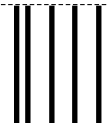

NO POSTAGE
NECESSARY
IF MAILED IN THE
UNITED STATES

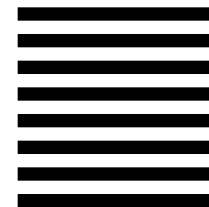

BUSINESS REPLY MAIL

FIRST-CLASS MAIL PERMIT NO. 40 ARMONK, NEW YORK

POSTAGE WILL BE PAID BY ADDRESSEE

ATTN DEPT 542 IDCLERK
IBM CORPORATION
3605 HWY 52 N
ROCHESTER MN 55901-9986



Fold and Tape

Please do not staple

Fold and Tape



Printed in the United States of America
on recycled paper containing 10%
recovered post-consumer fiber.

SC41-5704-00



Spine information:



AS/400 Advanced Series

IDDU Use

Version 4