

z/VM



Language Environment User's Guide

z/VM version 6 release 1

z/VM



Language Environment User's Guide

z/VM version 6 release 1

Note

Before using this information and the product it supports, read the information under “Notices” on page 125.

This edition applies to version 6 release 1, modification 0 of IBM z/VM (product number 5741–A05) and to all subsequent releases and modifications until indicated in new editions.

This edition replaces SC24–6101–02

© **Copyright International Business Machines Corporation 2003, 2009.**

US Government Users Restricted Rights – Use, duplication or disclosure restricted by GSA ADP Schedule Contract with IBM Corp.

Contents

Figures	vii
Tables	ix
About this document	xi
Unsupported z/OS functions	xi
Intended audience	xi
Where to find more information	xii
How to send your comments to IBM	xiii
If you have a technical problem.	xiii

Part 1. Language Environment Programming Guide. 1

Chapter 1. Preparing to load and run under Language Environment	3
Understanding the Basics	3
Planning to load and run.	3
Checking Which Run-Time Options Are in Effect	4
PL/I Considerations.	4
Replacing PL/I Library Routines in an OS PL/I Executable Program	4
Chapter 2. Loading and Running under z/VM	5
Basic Linking and Running	5
Accepting the Default Run-Time Options	5
Overriding the Default Run-Time Options.	6
Using the GLOBAL Command.	6
Resolving External References to Resident Routines	7
Resolving External References to Dynamic Routines	7
C/C++ Considerations.	8
COBOL Considerations	8
PL/I Considerations.	8
Determining the Search Order for Dynamic Routines	8
Using the LOAD and INCLUDE Commands.	9
C/C++ Considerations.	9
PL/I Considerations.	9
Using the LOAD Command.	9
VM/CMS Load Options	10
Using the INCLUDE Command	12
Using the GENMOD Command	12
Using the BIND Command	13
Using the NUCXLOAD Command	13
Restrictions	14
Example	14
Using FILEDEF to Define Input and Output Files	14
Link-Editing with the LKED Command	14
Using the CMOD EXEC	15
Using the LINKLOAD EXEC	17
Using the START Command	18
Using the iconv Utility and ICONV EXEC for C/C++	19
Using the genxlt Utility and GENXLT EXEC for C/C++	19
Running Your Application	19
Running a Module Produced by the BIND or GENMOD Command.	20
Running a Module Using the OSRUN Command	20

Using the VM/CMS Extended Parameter List	21
Chapter 3. Building, Loading, and Running under OpenExtensions	23
Basic Building and Running C/C++ Applications under OpenExtensions	23
Invoking the OpenExtensions Shell	23
Using the OpenExtensions c89 Utility to Create Executable Files	23
Prelinker Options	24
Specifying Run-Time Options under OpenExtensions	25
Running under OpenExtensions	25
OpenExtensions Application Program Environments	25
Placing a CMS Application Program Load Module in the File System	25
Running a CMS Module from the OpenExtensions Shell.	25
Running an OpenExtensions C/C++ Application Executable File from the OpenExtensions Shell	26
Basic Building and Running PL/I routines under OpenExtensions	26
Chapter 4. Initialization and Termination under Language Environment	27
How the Language Environment Enclave Return Code Is Calculated	27
z/VM Considerations	27
Chapter 5. Using and Handling Messages	29
Creating Messages	29
Creating a Message Source File	29
Using the CEEBLDTX Utility	30
Files Created by CEEBLDTX.	31
Run-Time Messages with POSIX	33
Handling Message Output	34
Using Language Environment MSGFILE	34
Using MSGFILE under OpenExtensions.	35
Using C or C++ I/O Functions	35
Using COBOL I/O Statements	36
Using PL/I I/O Statements.	38
MSGFILE Considerations When Using PL/I	39
Chapter 6. Using Run-Time User Exits	41
Understanding the Basics	41
User Exits Supported under Language Environment	41
PL/I and C Compatibility	42
Using Sample Assembler User Exits	42
When User Exits Are Invoked	43
CEEEXITA Behavior During Enclave Initialization	44
CEEEXITA Assembler User Exit Interface	44
Chapter 7. Using Preinitialization Services	49
Service Routines	49
An Example Program Invocation of CEEPIPI	56
Chapter 8. Using Nested Enclaves	61
Understanding the Basics	61
XPLINK Considerations.	61
COBOL Considerations.	62
Determining the Behavior of Child Enclaves	62
Creating Child Enclaves by Calling a Second Main Program	62
Creating Child Enclaves Using SVC LINK or CMSCALL.	62
Creating Child Enclaves Using the C system() Function	65
Creating Child Enclaves Containing a PL/I Fetchable Main.	66

Other Nested Enclave Considerations	68
What the Enclave Returns from CEE3PRM	68
Finding the Return and Reason Code from the Enclave	70
Assembler User Exit	70
Message File	70
OpenExtensions Considerations	70
AMODE Considerations	70

Part 2. Language Environment Debugging Guide 71

Chapter 9. Debugging C/C++ Routines	73
Debugging C/C++ Input/Output Programs	73
__last_op Values	73
Using __errno2() to Diagnose Application Problems	76
Generating a Language Environment Dump of a C/C++ Routine.	77
cdump()	77
csnap().	78
Chapter 10. Diagnosing Problems with Language Environment	79
Diagnosis Checklist	79

Part 3. Language Environment Run-Time Messages 81

Chapter 11. C/C++ Run-Time Messages	83
Chapter 12. COBOL Run-Time Messages	85

Part 4. Customizing 87

Chapter 13. Customizing	89
Updating Run-Time Options	89
Updating User Exit Options	90
C Component Locale Time Information	90
Updating Saved Segments	90
Updating the COBOL Component Reusable Environment	91
Modifying the behavior of the COBOL Reusable Environment.	92
Appendix A. Prelinking an Application	93
Which Programs Need to Be Prelinked	93
What the Prelinker Does	94
Prelinking Process	94
Primary Input	94
INCLUDE Control Statements	94
References to Currently Undefined Symbols (External References).	95
Processing the Prelinker Automatic Library Call	95
Language Environment Prelinker Map	96
Control Statement Processing	100
IMPORT Control Statement	100
INCLUDE Control Statement	100
LIBRARY Control Statement	101
RENAME Control Statement	101
Mapping L-Names to S-Names	102
Starting the Prelinker	103
Examples	104
Prelinker Options	104

Appendix B. Parameter List Formats	107
C and C++ Parameter Passing Considerations.	107
C PLIST and EXECOPS Interactions	109
Parameter Passing Considerations with XPLINK C and C++.	110
COBOL Parameter Passing Considerations	111
PL/I Main Procedure Parameter Passing Considerations	111
Appendix C. Object Library Utility.	113
Creating an Object Library	113
The LINKLOAD EXEC.	114
Object Library Utility Map.	116
Appendix D. Using the Systems Programming Environment	119
Building Freestanding Applications	119
Building Freestanding Applications	119
Special Considerations for Reentrant Modules	120
Building System Exit Routines	121
Building Persistent C Environments	121
Building User-Server Environments	121
Summary	122
Notices	125
Programming Interface Information	127
Trademarks.	127
Glossary	129
Bibliography	131
Where to Get z/VM Information	131
z/VM Base Library	131
Overview	131
Installation, Migration, and Service	131
Planning and Administration.	131
Customization and Tuning	131
Operation and Use	131
Application Programming.	131
Diagnosis	132
z/VM Facilities and Features	132
Data Facility Storage Management Subsystem for VM	132
Directory Maintenance Facility for z/VM	132
Open Systems Adapter/Support Facility	132
Performance Toolkit for VM	133
RACF Security Server for z/VM	133
Remote Spooling Communications Subsystem Networking for z/VM	133
Prerequisite Products	133
Device Support Facilities.	133
Environmental Record Editing and Printing Program.	133
Additional publications.	133
Index	135

Figures

1. Example of a Message Source File	30
2. Location of User Exits	43
3. Interface for CEEBXITA Assembler User Exit	45
4. CEEAUE_FLAGS Format.	46
5. Format of Service Routine Vector.	49
6. Assembler Driver That Creates a Preinitialized Environment	57
7. Example of a Routine Using <code>__errno2()</code>	77
8. Example of a Routine Using <code>_EDC_ADD_ERRNO2</code>	77
9. Sample Output of a Routine Using <code>_EDC_ADD_ERRNO2</code>	77
10. Customization EXEC - Panel 1.	89
11. Prelinker Map	97
12. Some Alternate C/C++ Parameter Passing Styles	107
13. Accessing Parameters Using Macros <code>__R1</code> and <code>__osplist</code>	108
14. Examples of Casting and Dereferencing	109
15. Object Library Utility Map	116
16. Specifying Alternate Initialization at Link-Edit	119
17. Simple Freestanding z/VM Routine.	120
18. Building a Freestanding z/VM Routine	120
19. Simple Reentrant Freestanding z/VM Routine	120
20. Building a Reentrant Freestanding VM Routine	120

Tables

1. Selected CMS Load Options	10
2. CMOD options.	15
3. LINKLOAD Options	17
4. Condition Tokens with POSIX	33
5. Operating System, SYSOUT Definitions, MSGFILE Default Attributes	34
6. Defining an I/O Device for a ddname	35
7. C and C++ Message Output	36
8. C/C++ Redirected Stream Output.	36
9. Run-time Message and DISPLAY Destinations for OUTDD and MSGFILE ddname Specifications under VM	38
10. User Exits Supported under Language Environment	41
11. Interaction of Assembler User Exits	42
12. Sample Assembler User Exits for Language Environment	42
13. Return and Reason Codes	50
14. Return and Reason Codes	51
15. Return and Reason Codes	52
16. Return and Reason Codes	52
17. Return and Reason Codes	54
18. Parameters for EXCEPRTN	54
19. Return and Reason Codes	54
20. Return and Reason Codes	55
21. Handling Conditions in Child Enclaves	63
22. Unhandled Condition Behavior in a C or Assembler Child Enclave, under CMS	63
23. Unhandled Condition Behavior in a COBOL Child Enclave, under z/VM.	64
24. Unhandled Condition Behavior in a PL/I Child Enclave, under z/VM	65
25. Unhandled Condition Behavior in a system()-Created Child Enclave, under z/VM	66
26. Unhandled Condition Behavior in a Child Enclave That Contains a Fetchable Main, under z/VM	67
27. Determining the Command-Line Equivalent	68
28. Determining the Order of Run-Time Options and Program Arguments	69
29. __last_op Values and Diagnosis Information.	73
30. Prelinker Options	105
31. Interactions of C PLIST and EXECOPS (#pragma runopts)	110
32. Interactions of SYSTEM and NOEXECOPS under z/VM	112
33. Summary of Types.	122

About this document

This edition of the z/VM[®] Language Environment[®] User's Guide is intended to provide z/VM Language Environment users with information unique to the z/VM platform. The document is a supplement to the V1R9 z/OS[®] Language Environment manuals and should be used in conjunction with them.

This document is organized as follows:

- Part 1 describes Language Environment programming information unique to the z/VM platform. For more information regarding Language Environment programming, see *z/OS: Language Environment Programming Guide*.
- Part 2 describes Language Environment debugging information unique to the z/VM platform. For more information regarding Language Environment debugging, see *z/OS: Language Environment Debugging Guide*.
- Part 3 describes Language Environment run-time information unique to the z/VM platform. For more information regarding Language Environment run-time messages, see *z/OS: Language Environment Run-Time Messages*.
- Part 4 describes Language Environment customizing information unique to the z/VM platform.
- The various appendixes describe prelinking, using parameter list formats, using the C object library, and systems programming environments.

Unsupported z/OS functions

The following major functions in the corresponding level of Language Environment on z/OS are not supported on z/VM:

- AMODE 64
- ASCII functions
- The following run-time options or parameters are not supported:
 - CEEDUMP(60,SYSOUT=*,FREE=END,SPIN=UNALLOC) - option not supported
 - DYNDUMP(*USERID,NODYNAMIC,TDUMP) - option not supported
 - HEAPCHK(OFF,1,0,0,0) - last parameter (0) not supported
 - HEAPPOOLS(OFF,8,10,32,10,128,10,256,10,1024,10,2048,10,0,10,0,10,0,10,0,10,0,10,0,10) - last 12 parameters not supported

Other differences in functionality will be noted in the appropriate documentation.

Intended audience

To use this document you should be familiar with the Language Environment product and one or more of the supported Language Environment-conforming high-level languages listed above. The term C/C++ is used generically to refer to information that applies to both C and C++.

Previous versions of the Language Environment-conforming language products provided their own environment and services for running applications, and their associated application programming guides including information on how to link-edit and run applications. Language Environment now provides the run-time support required to run applications compiled under all of the Language

Environment-conforming HLLs, as well as the facility for interlanguage communication between supported languages.

Where to find more information

For more information about z/VM functions, see the documents listed in the “Bibliography” on page 131.

Links to Other Online Documents

If you are viewing the Adobe® Portable Document Format (PDF) version of this document, it might contain links to other documents. A link to another document is based on the name of the requested PDF file. The name of the PDF file for an IBM document is unique and identifies the edition. The links provided in this document are for the editions (PDF names) that were current when the PDF file for this document was generated. However, newer editions of some documents (with different PDF names) might exist. A link from this document to another document works only when both documents reside in the same directory.

How to send your comments to IBM

We appreciate your input on this publication. Feel free to comment on the clarity, accuracy, and completeness of the information or give us any other feedback that you might have.

Use one of the following methods to send us your comments:

1. Send an e-mail to mhvrcfs@us.ibm.com
2. Visit the z/VM reader's comments Web page at www.ibm.com/systems/z/os/zvm/zvmforms/webqs.html
3. Mail the comments to the following address:
IBM Corporation
Attention: MHVRCFS Reader Comments
Department H6MA, Mail Station P181
2455 South Road
Poughkeepsie, NY 12601-5400
U.S.A.
4. Fax the comments to us as follows:
From the United States and Canada: 1+845+432-9405
From all other countries: Your international access code +1+845+432-9405

Include the following information:

- Your name and address
- Your e-mail address
- Your telephone or fax number
- The publication title and order number:
z/VM V6R1 Language Environment User's Guide
SC24-6199-00
- The topic and page number related to your comment
- The text of your comment

When you send comments to IBM, you grant IBM a nonexclusive right to use or distribute your comments in any way it believes appropriate without incurring any obligation to you.

IBM or any other organizations will only use the personal information that you supply to contact you about the issues that you submit to IBM.

If you have a technical problem

Do not use the feedback methods listed above. Instead, do one of the following:

- Contact your IBM service representative.
- Contact IBM technical support.
- Visit the z/VM support Web page at www.vm.ibm.com/service/
- Visit the IBM mainframes support Web page at www.ibm.com/systems/support/z/

Part 1. Language Environment Programming Guide

Chapter 1. Preparing to load and run under Language Environment

This chapter discusses z/VM specific information that you need to know before loading and running applications under Language Environment. After Language Environment is installed on your system, you should run an existing application under Language Environment. Although you may need to load different libraries, the procedure is similar to that used in pre-Language Environment versions of C, COBOL, or PL/I. For more information about running applications under Language Environment, see *z/OS: Language Environment Programming Guide* and the individual language migration guides.

Restriction: Language Environment does not support Fortran applications in the z/VM environment.

Understanding the Basics

Language Environment library routines are divided into two categories: *resident routines* and *dynamic routines*. The resident routines are linked with the application and include such things as initialization/termination routines and pointers to callable services. The dynamic routines are not part of the application and are dynamically loaded during run time.

The way Language Environment code is packaged keeps the size of application executable programs small. When maintaining dynamic library code, you need not reload the application code except under special circumstances, such as when you use an earlier version of code.

The linkage editor converts an object module into an executable program and stores it in a library. The executable program can then be run from that library at any time. The load process combines output from compilers, language translators, load programs and control statements to produce an executable program (load module or program object) and stores it in a library. The executable program can then be run from that library. Either the program management binder or linkage editor can be used to perform the load process. All of the services of the linkage editor can be performed by the binder. In addition, the binder provides additional functionality and usability improvements. See *z/VM: Program Management Binder for CMS* for a complete discussion of services to create, load, modify, list, read, transport and copy executable programs.

Planning to load and run

There are certain considerations for z/VM that you must be aware of before loading and running applications under Language Environment. They are:

- Language Environment resident routines, including those for callable services, initialization, and termination, are located in the following libraries:
 - SCEELKED TXTLIB - for non-XPLINK C application programs
 - SCEECPP TXTLIB - for non-XPLINK C++ application programs
 - SCEEBND2 TXTLIB - for XPLINK C and C++ application programs
- Language Environment dynamic routines are located in relocatable CMS MODULEs and SCEERUN LOADLIB. The relocatable CMS MODULEs can be installed as nucleus extensions or in shared segments.

Checking Which Run-Time Options Are in Effect

Using the Language Environment run-time option RPTOPTS, you can control whether a run-time options report is produced; with the Language Environment run-time option MSGFILE, you can control where report output is directed. RPTOPTS generates a report of all the run-time options that are in effect when your application begins to run. The IBM-supplied default for RPTOPTS is OFF, meaning a report is not generated when your application finishes running. If you override the default setting of RPTOPTS in any of the ways described below, a report is sent to the default location:

- In a POSIX (ON) application it goes to file descriptor 2.
- In a POSIX(OFF) application if you override the default setting of RPTOPTS, a report is sent to the FILEDEF specified by SYSOUT unless you override the MSGFILE run-time option to specify a different location. The default destination for any MSGFILE output is the TERMINAL unless you change it by issuing a FILEDEF for the file specified in the MSGFILE option.

If you want to change the options report destination, you can alter the default setting of the MSGFILE run-time option, which specifies where all run-time diagnostics and messages are written. For example, if you specify MSGFILE(OPTRPRT) and RPTSTG(ON), the storage report is written to a file whose *ddname* is OPTRPRT. The default runtime options can also be customized. See “Updating Run-Time Options” on page 89 for more information.

For the syntax of RPTOPTS and MSGFILE, see *z/OS: Language Environment Programming Reference*.

PL/I Considerations

The information that follows is additional for use with z/VM when using *z/OS: Language Environment Programming Guide*.

Replacing PL/I Library Routines in an OS PL/I Executable Program

Under VM, you can use the PL/I library replacement tool IBMWRLK TEXT (a member of SCEELKED TXTLIB) to replace the OS PL/I library routines in your OS PL/I executable programs with the analogous Language Environment resident routines. The executable programs must be created with the LKED command and reside in CMS LOADLIBs. It is not possible to replace run-time library routines in a file of type MODULE created by the GENMOD command.

For further information on library routine replacement, see *PL/I for MVS & VM Compiler and Run-Time Migration Guide*.

Chapter 2. Loading and Running under z/VM

Before you can run a program under z/VM, you must issue one of the following commands:

- LOAD (Stores a copy of the program in virtual storage)
- GENMOD (Stores the program on disk)
- LKED (Stores the program in a LOADLIB)
- BIND (Stores the program on disk using the Program Management binder)

z/VM produces an object module with the file type TEXT when you compile your program. Before you run the program, external references inserted by the compiler must be resolved. Use one of the following methods to create an executable application; you can run your application after you complete any of these steps.

- Create a temporary copy of your program in virtual storage by using LOAD and INCLUDE commands. No permanent copy of the executable program is made.
- Create a module using LOAD, INCLUDE, GENMOD, and/or BIND commands if appropriate. A module is an executable application that is stored as a file with a file type of MODULE.
- Create a module in a member of a library using the LKED command. This method link-edits an executable application and stores it as a load module in a member of a CMS LOADLIB.
- Create a module using the CMOD EXEC (C applications only). See “Using the CMOD EXEC” on page 15 for more information.

OpenExtensions has its own section on linking, loading, and running C applications and PL/I routines in those applications (see Chapter 3, “Building, Loading, and Running under OpenExtensions,” on page 23).

Restrictions:

- VisualAge® PL/I and Enterprise PL/I are not supported on z/VM. Language Environment continues to provide support for PL/I applications under z/VM compiled with PL/I for MVS & VM, and previous, supported levels of the PL/I compiler.
- Language Environment does not support Fortran applications in the z/VM environment.
- Enterprise COBOL for z/OS and OS/390®
- COBOL programs compiled with the DLL or ARITH(EXTEND) compiler options are not supported on z/VM.
- COBOL programs using object oriented constructs, LINE SEQUENTIAL files, or dynamic allocation using environment variables are not supported on z/VM.
- COBOL multi-threaded or multi-tasking programs are not supported on z/VM.

Basic Linking and Running

This section describes how to accept and to override the default Language Environment run-time options.

Accepting the Default Run-Time Options

Use the following series of CMS GLOBAL, LOAD, and START commands to accept default run-time options:

Running under z/VM

```
GLOBAL TXTLIB SCEELKED
GLOBAL LOADLIB SCEERUN
LOAD MYPROG
START *
```

This series of commands does the following:

- Identifies text libraries that you want z/VM to search to resolve external references in your object code, including the Language Environment SCEELKED (text) link library, and any libraries where your text files are located
- Links one or more text files containing object code and loads them into storage
- Runs the image of the application that is assembled in storage by the LOAD command.

Overriding the Default Run-Time Options

If MYPROG is a C/C++ or a PL/I application that uses routines from SCEELKED and MYTXTLB and wants to send Language Environment MSGFILE output (including the options report) to file OPTRPRT, issue the following commands:

```
GLOBAL TXTLIB SCEELKED MYTXTLB
LOAD MYPROG
GLOBAL LOADLIB SCEERUN
FILEDEF OPTRPRT DISK OPTRPRT OUTPUT A
START * RPTOPTS(ON), MSGFILE(OPTRPRT)/
```

If MYPROG above is a COBOL application, then you need to modify the START command to be:

```
START * / RPTOPTS(ON), MSGFILE(OPTRPRT)
```

For more information, see “Using the GLOBAL Command,” “Using the LOAD and INCLUDE Commands” on page 9, and “Using the START Command” on page 18.

Using the GLOBAL Command

You must issue a GLOBAL command before using the CMS LOAD command and before running applications. The syntax of the GLOBAL command is:

Syntax

```
▶▶ GLOBAL — LOADLIB ————— libname1 — ... — libname63 —▶▶
      |
      |—TXTLIB—
      |
      |—other keywords—
```

LOADLIB

Specifies the load module libraries to be searched for a module that the OSRUN command or the LINK, LOAD, ATTACH, or XCTL macros refer to. The libraries can be CMS LOADLIBs or OS module libraries. If you specify an OS data set, issue a FILEDEF command for the data set before you issue the GLOBAL command.

TXTLIB

Specifies the text libraries to be searched for missing subroutines when the LOAD or INCLUDE command is issued, when the LKED command is issued, or when a dynamic load occurs (that is, when an OS SVC 8 or SVC 122 is issued).

Subroutines that are dynamically loaded should contain only VCONs that are resolved within the same text library member or that are resident in storage

throughout the processing of the original CMS LOAD or INCLUDE command. Otherwise, the entry point is unpredictable.

other keywords

Additional GLOBAL keywords which do not apply to loading or running an application under z/VM and are, therefore, not shown here.

libname1 - libname63

The file names of up to 63 libraries of the specified file type (LOADLIB or TXTLIB). The libraries are searched in the order in which they are named. The library list is subject to other system limits, such as command line length. This command supersedes any previous GLOBAL command for the specified file type. If no file names are specified, the command cancels any previous GLOBAL command for this file type.

Resolving External References to Resident Routines

A GLOBAL TXTLIB command must be issued for the Language Environment text library to resolve external references to the Language Environment resident routines before a CMS LOAD command is issued. Before loading an application, issue the following command:

```
GLOBAL TXTLIB SCEELKED usertxt
```

SCEEBND2

The Language Environment C++ text library for XPLINK application programs.

SCEECPP

The Language Environment C++ text library for non-XPLINK application programs.

SCEELKED

The Language Environment text library.

usertxt

The name of any user-generated text library or libraries to be searched for text files needed by your application.

Resolving External References to Dynamic Routines

Before running your application, you must issue a GLOBAL LOADLIB command; this enables the Language Environment LOADLIB to resolve external references to the Language Environment dynamic routines:

```
GLOBAL LOADLIB SCEERUN userload
```

SCEERUN

Identifies the Language Environment load library.

userload

The name of any user-generated load library or libraries to be searched for load modules needed by your application.

Check with your system administrator to find out where Language Environment dynamic routines are located at your installation. In addition to a set of relocatable load modules and the load library SCEERUN LOADLIB, some Language Environment routines might have been installed in a nucleus extension or a saved segment.

Running under z/VM

C/C++ Considerations

If your C/C++ application performs long double arithmetic or uses extended-precision arithmetic, you must also specify the CMSLIB text library in your GLOBAL TXTLIB command. You can combine the CMSLIB with other TXTLIBs, as follows:

```
GLOBAL TXTLIB SCEELKED CMSLIB usertext
```

In addition to specifying CMSLIB, the C/C++ application must be run with TRAP(ON,SPIE).

COBOL Considerations

To run OS/VS COBOL programs, you must specify the SCEERUN and SCEEILBO libraries on the GLOBAL LOADLIB command.

PL/I Considerations

The product structure for PL/I has changed from previous versions and most CMS EXECs that load a PL/I application using the OS PL/I library must be changed to include SCEELKED, SIBMMATH, or SIBMCALL.

- SCEELKED contains the stubs for PL/I library routines, in addition to Language Environment-conforming languages and Language Environment-provided routines and stubs.
- SIBMMATH contains the stubs for old OS PL/I V2R3 math library routines.
- SIBMCALL provides PLICALLA and PLICALLB compatibility for PL/I for MVS & VM applications that use OS PL/I PLICALLA or PLICALLB as an entry point.

SIBMCALL and SIBMMATH libraries must be concatenated before SCEELKED. They can be concatenated in any order.

For example, if your PL/I application requires OS PL/I math support, you must specify the SIBMMATH library. In link-edit steps, this library must precede SCEELKED if old math results are needed in a particular load module. You can combine the SIBMMATH with other LOADLIBs as follows: GLOBAL TEXTLIB SIBMMATH SCEELKED *usertext*

SIBMMATH

The Language Environment load library, containing the stubs for old OS PL/I V2R3 math library routines.

SCEELKED

The Language Environment text library.

usertext

The name of any user-generated text library or libraries to be searched for subroutines needed by your application.

Determining the Search Order for Dynamic Routines

The search order for dynamically loaded routines is:

1. Nucleus extension
2. Saved segments
3. Relocatable load modules
4. Load modules in LOADLIBs
5. Object modules
6. TXTLIB members

Normal CMS search order prevails when searching for a particular type in the previous list. Files on the A-disk are searched before files on the B-disk.

In general, the sooner a dynamically loaded routine is found, the better the performance of an application. For overall system performance gains, it is better to place heavily used dynamically loaded routines into a saved segment where they can be shared by all users.

Using the LOAD and INCLUDE Commands

The loader is invoked by using the LOAD command that reads one or more TEXT files (containing relocatable object code) or members of a text library from a minidisk or directory and loads them into virtual storage. LOAD establishes proper linkages between the files. The file containing the main routine should be the first file named in the command unless you specify the entry point name on the RESET option. The syntax of the LOAD command is:

Syntax

```
▶▶—LOAD—filename1—filename2—...—filename_n—[—(—options—  )]—▶▶
```

filename

Name of a file you want to load into storage.

options

List of LOAD options separated by blanks or commas (see Table 1 on page 10 for a list of available options).

Specify the RLDSAVE option for the LOAD command if you intend to use GENMOD. For more information about LOAD and its options, see *VM/ESA: CMS Command Reference*.

C/C++ Considerations

If the main routine is C/C++, specify the following under the options for the LOAD command:

```
RESET CEESTART
```

PL/I Considerations

If the main procedure is PL/I for MVS & VM, specify RESET CEESTART under the options for the LOAD command. For more information about using the LOAD command with PL/I, see *PL/I for MVS & VM Compiler and Run-Time Migration Guide*.

Using the LOAD Command

The following example causes the text library containing Language Environment resident routines, SCEELKED, and the USERTXT text library to be searched for files that your application needs to run. The files PROGRAM1 and CEEUOPT are loaded into virtual storage and a load map is written as follows:

```
GLOBAL TXTLIB SCEELKED USERTXT
LOAD PROGRAM1 CEEUOPT (MAP
```

VM/CMS Load Options

Table 1 contains a selection of CMS load options.

Table 1. Selected CMS Load Options

Option	Function
RESET <i>entry</i> *	<p>RESET sets the starting location for the applications currently loaded.</p> <p>The <i>entry</i> name must be an external name (for example, a CSECT control section or ENTRY) in the loaded applications.</p> <p>If you specify *, the results are the same as if the RESET option were omitted. If the RESET option is omitted, the default entry point is used.</p>
<u>MAP</u> NOMAP	<p>MAP writes a load map to a file in your minidisk or directory named LOAD MAP A5.</p> <p>NOMAP specifies that no LOAD MAP file is created.</p>
TYPE <u>NOTYPE</u>	<p>TYPE displays the load map at your terminal and writes it to a file on minidisk or directory.</p> <p>NOTYPE does not display the file at your terminal.</p>
<u>LIBE</u> NOLIBE	<p>LIBE searches text libraries for missing subroutines. The text libraries must be previously defined by a GLOBAL command.</p> <p>NOLIBE does not search text libraries for unresolved differences.</p>
START	Runs the application when loading has completed.
<u>NORLDSav</u> RLDSave	<p>NORLDSav instructs the CMS loader not to save relocation information from the TEXT files being loaded.</p> <p>Specify RLDSave if you plan to use the GENMOD command. RLDSave instructs z/VM to save relocation information from the text files. The GENMOD command uses relocation information to generate relocatable CMS modules.</p>
AMODE 24 31 ANY	<p>Specifies the addressing mode of the application in a 370-XA mode virtual machine. In a System/370 mode virtual machine, you can specify AMODE, although only 24-bit addressing is available. This allows you to create XA capable module files on an S/370™ mode virtual machine. Valid AMODE values are:</p> <p>24 The entry point of the application receives control in 24-bit addressing mode.</p> <p>31 The entry point of the application receives control in 31-bit addressing mode when running on a 370-XA mode virtual machine, and in 24-bit addressing mode on a System/370 mode virtual machine.</p> <p>ANY The entry point is capable of operating in either 24- or 31-bit addressing mode.</p>

Table 1. Selected CMS Load Options (continued)

Option	Function
RMODE 24 ANY	Specifies, in a 370-XA mode virtual machine with greater than 16M of storage, the location where the loaded application is to reside. Valid RMODE values are: <ul style="list-style-type: none"> 24 The load module must reside below the 16M line in a 370-XA virtual mode machine. ANY The load module must reside above the 16M line in a 370-XA virtual mode machine.
HOBSET HOBSETSD NOHOBSET	Specifies if the high-order bit for V-type constants (VCONs) of SD (CSECTs) or LD (ENTRYs) types is to be turned on or left unchanged. This option only applies to PL/I applications.
Note: Set loader tables (LDRTBLS) to a minimum of 6.	

HOBSET, HOBSETSD, and NOHOBSET PL/I Options

PL/I programs that execute with the CMS LOAD and INCLUDE commands can specify the HOBSET, HOBSETSD, or NOHOBSET option. The default is NOHOBSET.

HOBSETSD and HOBSET: PL/I programs that execute with the CMS LOAD and INCLUDE commands can contain entry addresses whose high-order bit is set if the referenced name has the AMODE 31/ANY attribute. This applies to:

- Both external CSECT and external label names, if the HOBSET option is in effect
- External CSECT names only, if the HOBSETSD option is in effect

The following considerations apply when using the HOBSETSD or HOBSET options:

Entry variables and constants generated by compiled code can have entry addresses whose high-order bit is set. A PL/I program can access such addresses by using:

- The ENTRYADDR or UNSPEC builtin/pseudovvariable
- The PL/I BASED or DEFINED language construct that allows entry variables to be overlaid
- Assembler routines that receive or pass the addresses

Entry addresses that have the high-order bit set should be used with care, such as in the following situations:

- Because the high-order bit can be set in such addresses, comparison to the PL/I NULL() value should be avoided.
- It might be necessary to preserve the high-order bit of entry addresses to ensure that entry variables are built correctly using the ENTRYADDR pseudovvariable.
- If an external procedure entry name is referenced within the external procedure itself, comparisons involving these entry references might produce unexpected results. This constraint applies only to the HOBSET option.

NOHOBSET: The high-order bit of entry addresses is always zero with this option. You can use this option without any of the restrictions and precautions described in “HOBSETSD and HOBSET.”

Using the INCLUDE Command

The LOAD command loads a TEXT file or member of a text library into virtual storage. The INCLUDE command loads additional TEXT files or members of a text library that make up your executable application.

The INCLUDE and LOAD commands have similar formats and option lists. The main difference is that if you issue two LOAD commands in succession, the second command replaces the first. The INCLUDE command, on the other hand, cannot be used unless you have just issued a LOAD. You can specify as many INCLUDE commands as necessary following the LOAD command to load files into storage. The files specified in the INCLUDE command must refer to subroutines. See Table 1 on page 10 for a list of available options.

The syntax of the INCLUDE command is:

Syntax

►► INCLUDE *filename1 filename2 ... filename_n* [-(*options*)]

filename

Name of a file you want to include into storage.

options

List of INCLUDE options separated by blanks or commas (for a list of available options, see Table 1 on page 10).

For more information about INCLUDE and its options, see *VM/ESA: CMS Command Reference*

The following example loads a TEXT file from the USERTXT text library and includes another TEXT file from another text library into the load module. A load map is also written.

```
GLOBAL TXTLIB SCEELKED USERTXT USERTXT2
LOAD PROGRAM1
INCLUDE PROGRAM2 (MAP
```

Using the GENMOD Command

Use the GENMOD command with the LOAD and INCLUDE commands to create application modules, that is, relocatable files whose external references have been resolved. In z/VM, these files must have a file type of MODULE. The syntax of the GENMOD command is:

Syntax

►► GENMOD *filename* [-(*options*)]

The GENMOD command takes a copy of the executable module in virtual storage and stores it onto a disk with a *filename* that you specify. In the following example, PROGRAM1, PROGRAM2, and PROGRAM3 are TEXT generated from C source files that are put into a module with a file name of PROGRAM1 and a file type of MODULE:

```
GLOBAL SCEELKED USERTXT
LOAD PROGRAM1 PROGRAM2 PROGRAM3 (RLDSAVE RESET CEESTART
GENMOD PROGRAM1 (NOMAP
```

If you use the name of an existing module, the previous version of the module is replaced. If you do not specify in *filename* the name of the file where you want the load module to be stored, the GENMOD command processor defaults to the first entry point in the load map.

If the main entry point module is a PL/I or C application, load the object modules into storage using the RLDSAVE option and issue the GENMOD COMMAND using the FROM CEESTART option.

For ILC applications that dynamically load or fetch other programs, you must specify the RLDSAVE option of the LOAD statement and the NOMAP option of the GENMOD statement.

After you create the module with GENMOD, run the application composed of the source files PROGRAM1, PROGRAM2, and PROGRAM3 by entering:

```
PROGRAM1
```

Using the BIND Command

Use the BIND command to create application modules, that is, relocatable files whose external references have been resolved. In VM, these files must have a file type of MODULE. The syntax of the BIND command is:

Syntax

```

  ──┬── BIND ──┬── filename ──┬── [ ( options ) ] ──┬──
      │         │                 │                   │
      └──┬──┘         └──┬──┘         └──┬──┘         └──┬──┘

```

The BIND command takes a copy of the executable module in virtual storage and stores it onto a disk with a filename that you specify. In the following example, PROGRAM1, PROGRAM2, and PROGRAM3 are TEXT files that are put into a module with a file name of PROGRAM1 and a file type of MODULE:

```
GLOBAL TXTLIB SCEELKED USERTXT
BIND PROGRAM1 PROGRAM2 PROGRAM3
```

If you use the name of an existing module, the previous version of the module is replaced. If you do not specify in *filename* the name of the file where you want the load module to be stored, the BIND command processor defaults to the first entry point in the load map.

After you create the module with BIND, run the application composed of the source files PROGRAM1, PROGRAM2, and PROGRAM3 by entering:

```
PROGRAM1
```

Using the NUCXLOAD Command

Use NUCXLOAD to load the modules into storage and install them as nucleus extensions. You can use the NUCXLOAD command if the RLD information has been saved during the CMS LOAD command using the RLDSAVE option.

Restrictions

Only reentrant modules can be installed as nucleus extensions. In PL/I for MVS & VM, use the REENTRANT procedure option; in COBOL for OS/390 & VM, COBOL for MVS & VM, COBOL/370, or VS COBOL II, use the RENT compiler option to ensure that a module can be installed as a nucleus extension. OS/VS COBOL modules cannot be installed as nucleus extensions because OS/VS COBOL cannot generate reentrant code.

C/C++ object modules that contain L-names or that are not naturally reentrant must be compiled with the RENT option and prelinked before being installed as nucleus extensions.

Example

In the following example, a CMS MODULE is created from a PL/I program, PROGRAM1. The TEXT file is loaded into storage and the RLD information is saved during the CMS LOAD using the RLDSAVE option. For PL/I, the GENMOD command requires the FROM CEESTART option as shown below:

```
GLOBAL TXTLIB SCEELKED
LOAD PROGRAM1 (RLDSAVE RESET CEESTART
GENMOD PROGRAM1 (NOMAP FROM CEESTART
NUCXLOAD PROGRAM1
PROGRAM1
```

For more information about the LOAD, GENMOD, and NUCXLOAD commands, see *z/VM: CMS Commands and Utilities Reference* and *VM/ESA: CMS User's Guide*.

Using FILEDEF to Define Input and Output Files

If your program requires input and/or output files, you must define these files using the CMS FILEDEF command prior to executing the module. The FILEDEF command relates the ddname of the input or output file specified in your program with an I/O device. For example, if PROGRAM1 contains a ddname of an input file stored on your A disk as MYDATA INPUT, issue the following command (*infile* is the ddname of the input file specified in PROGRAM1):

```
FILEDEF infile DISK MYDATA INPUT A
```

For more information about the GENMOD and FILEDEF commands, refer to *VM/ESA: CMS Command Reference*.

Link-Editing with the LKED Command

The LKED command is used to create a member of a CMS load library. CMS load libraries, like text libraries, are in CMS partitioned data set format. Text libraries contain applications that contain unresolved external references to other routines. Load libraries, on the other hand, contain applications with external references that have already been resolved, thus saving overhead every time the application is loaded.

Your TEXT file is input to the LKED command. If your application calls a subroutine with object code stored as a separate TEXT file or as a member of a text library, you must define the files that contain the subroutines used by your application with a FILEDEF command.

After you issue the appropriate FILEDEF commands, issue the LKED command.

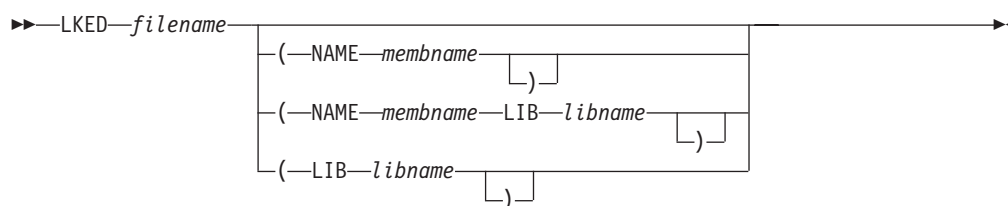
Syntax**filename**

Name of the TEXT file that contains your object code, linkage editor control cards, or both.

NAME memname

Member name to be used for the load module that is created.

LIB libname

Name of the LOADLIB file where the resulting load module is placed.

The following example causes the automatic call library to search SCEELKED to resolve external references, creates a load library member named PROGRAM1, and stores it in a CMS load library with the name USERLOAD.

```

FILEDEF SYSLIB DISK SCEELKED TXTLIB E
LKED PROGRAM1 (NAME PROGRAM1 LIB USERLOAD)
  
```

For more information about the LKED command and a complete list of options, see *VM/ESA: CMS Command Reference*.

Using the CMOD EXEC

The IBM-supplied CMOD EXEC invokes the loader or the binder (depending on the parameters passed or the compiler being used), which loads one or more object modules into virtual storage, resolves external references, and creates an executable module with the file type of MODULE. This EXEC can be used by C/C++ applications only. The syntax of the CMOD EXEC is:

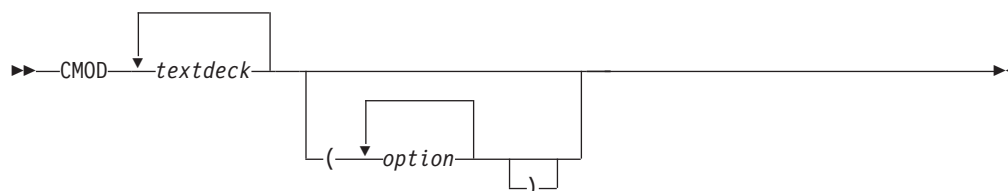
Syntax**textdeck**

Name of the input text decks; the file type must be TEXT.

options

Options you want to apply as the executable module is being generated. The options are listed in Table 2.

Table 2. CMOD options

Option	Description
Binder specific options	

Running under z/VM

Table 2. CMOD options (continued)

Option	Description
BINDOPTS(<i>options</i>)	Specifies options for the Binder. These options may be any of the options supported by the Binder.
C++	Specifies that at least one of the text decks is C++. This must be specified for C++ code to be correctly linked.
DLL(<i>side file name(s)</i>)	<p>If a side file name is not specified, this just passes the DYNAM DLL option to the Binder. It is the same as specifying BINDOPTS(DYNAM DLL), which enables the module for dynamic linking. A definition side file will be produced with the same name as the first text deck name, and a file type of SYSDEFSD.</p> <p>If a side file name is specified, the DYNAM DLL option is still passed to the Binder, but also the Binder will process the definition side file specified. An 8 character CMS file name is specified. CMOD will look for that file name with a file type of SYSDEFSD. Multiple names can be specified, separated by blanks.</p>
XPLINK	Specifies that the text deck(s) has been compiled with the XPLINK option. Generally speaking, XPLINK text decks cannot be bound with non-XPLINK text decks.
LOAD/GENMOD/Prelinker specific options	
AMODE	Specifies the addressing mode in which the program will be entered in a virtual machine. For a complete description of AMODE, refer to the LOAD command in the CMS command reference manual.
AUTOINOAUTO	Specifies that your disks are to be searched for TEXT files for use in resolving undefined references.
CPLINK(<i>options</i>)	Specifies options for the Prelinker.
DUPINODUP	Specifies that an error message is to be generated if duplicate CSECT names are encountered. If you want to ensure that only one copy of a object module is loaded, use the NODUP option.
GENMOD(<i>options</i>)	Passes any options to the GENMOD command.
INVINOINV	Specifies that invalid card images are not to be included in the load map.
LETINOLET	Specifies that all LOAD errors for the load module are to be ignored and an attempt to generate a module will be made.
ORIGIN	Specifies where CMS loads the program. This location must be in the CMS transient area or in any free CMS storage.
RLDINORLD	Specifies that relocation directory information is to be saved in the load module.
STRINOSTR	Specifies that storage is to be initialized during the generation of the executable module.
RMODE	Specifies where the program is to reside in a virtual machine with greater than 16MB of storage. For a complete description of RMODE, refer to the LOAD command in the CMS command reference manual.
Common options	
MAPINOMAP	The specified option is passed to the Binder or the LOAD command. For MAP (which is the default), the Binder will incorporate a module map into the SYSPRINT output; the LOAD command will generate a load map file on your A disk with the name LOAD MAP A.

Table 2. CMOD options (continued)

Option	Description
MODNAME <i>modulename</i>	The default is to generate an executable module having the same file name as the first object module specified, a file type of MODULE, and a file mode of A. The MODNAME option allows you to give a specific name to the executable module. Specify the module name (<i>modulename</i>) immediately following the MODNAME keyword, and the CMOD EXEC creates an executable module named <i>modulename</i> MODULE A.

Using the LINKLOAD EXEC

Use the IBM-supplied LINKLOAD EXEC to produce the fetchable C/C++ members in a CMS load library. For more information, see *z/OS XL C/C++ Programming Guide*. The LINKLOAD EXEC is used only by C/C++. The syntax of the LINKLOAD EXEC is:

Syntax

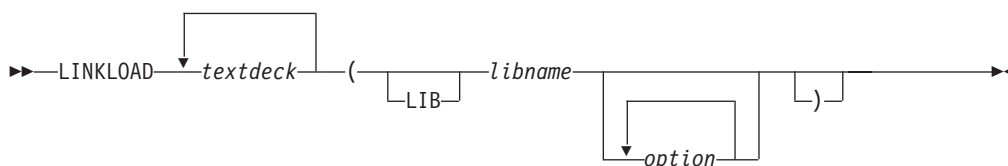

textdeck

Name of input text decks. The file type of the text decks must be TEXT and the source code must contain a `#pragma linkage(name,FETCHABLE)` preprocessor directive.

Do not specify the file type or file mode when using this EXEC.

option

Options you want to apply as the fetchable load module is being generated. The options are listed in Table 3.

Table 3. LINKLOAD Options

Option	Function
LIB <i>libname</i>	A keyword used to indicate that the next argument, <i>libname</i> , is the name of the library where the load member is to be stored. The library name parameter must be specified, but if it is the first parameter, the keyword LIB is optional.
CPLINK (<i>options</i>)	Allows you to pass options to the prelinker. CPLINK is called if it is required by the text decks or if a CPLINK option is given. See Appendix A, "Prelinking an Application," on page 93 for more information.
MBR <i>memname</i>	A keyword specifying that the next argument, <i>memname</i> , is the name of the member within the load library that is to be generated. If you do not specify a <i>memname</i> , the name of the text deck containing the fetchable code is used.

Table 3. LINKLOAD Options (continued)

Option	Function
ADD REPLACE NEW	One of these options can be specified on a given invocation of LINKLOAD:
ADD	Specifies that the load member generated by LINKLOAD is to be added to the load library. If a member by the same name already exists, the new member is not added.
REPLACE	Specifies that the load member generated by LINKLOAD is to replace a member by the same name in the load library. If the member does not already exist, the new member is added.
NEW	Specifies that an existing load library of the same name containing only the named member is created. The existing load library is replaced by the new library containing only the named member.
LKED (<i>options</i>)	Allows you to pass options to the LKED command. For more information on the LKED command, see “Link-Editing with the LKED Command” on page 14.

Using the START Command

After you load your application into virtual storage with the LOAD command and issue the appropriate GLOBAL commands, use the CMS START command to execute your application. The syntax of the START command is:

Syntax

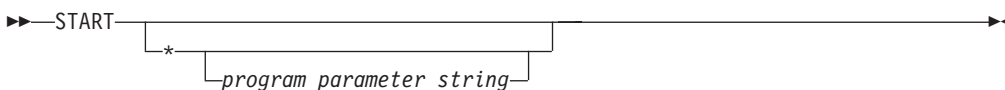

- * Specifies that control passes to the application's default entry point at execution time. This option is required if program parameters are passed. (For information about how the default entry point is determined, see *z/OS: Language Environment Programming Guide*.) You can also indicate an entry point whose name you specify in the application.

program_parameter_string

Specifies the run-time options and program parameters passed to the main routine in the application. The run-time options and program parameters are normally separated by a slash but C/C++ and PL/I users must omit the slash (unless it is part of a program parameter) if the NOEXECOPS run-time option is in effect.

In the following example, the compiled program PROGRAM1 is loaded and run with the RPTSTG(ON) and RPTOPTS(ON) run-time options specified:

```

GLOBAL TXTLIB SCEELKED USERTXT
LOAD PROGRAM1
GLOBAL LOADLIB SCEERUN

```

```
START * RPTSTG(ON),RPTOPTS(ON)/
```

Note: For COBOL programs, the "/" must be specified first by default.

In the case of an application for which you do not supply any run-time options or parameters, you can load and execute by using the START option of the LOAD command: `LOAD PROGRAM1 (START`

In C/C++, you can use EXECOPS in the `#pragma runopts` directive to enable the passing of run-time options in the START command. If NOEXECOPS is similarly specified, any run-time options specified on the command line are treated as program parameters. For more information on how to specify run-time options, see *z/OS: Language Environment Programming Guide*.

Using the iconv Utility and ICONV EXEC for C/C++

The `iconv` utility uses the `iconv_open()`, `iconv()`, and `iconv_close()` functions to convert the input file records from the coded character set definition for the input code page to the output code page. There is one record in the output file for each record in the input file. No padding or truncation of records is performed.

When conversions are performed between single-byte code pages, the output records are the same length as the input records. When conversions are performed between double-byte code pages, the output records can be longer or shorter than the input records because the shift-out and shift-in characters could be added or removed.

The ICONV EXEC invokes the `iconv` utility, which copies the input file to the output file and converts the characters from the input code page to the output code page. It can be invoked under VM/CMS or z/VM batch.

For information on the `iconv` utility, see *XL C/C++ for z/VM: User's Guide*.

Using the genxlt Utility and GENXLT EXEC for C/C++

The `genxlt` utility reads character conversion information from the input file and writes the compiled version to the output file. The input file contains directives that are acted upon by the `genxlt` utility to produce the compiled version of the conversion table.

The GENXLT EXEC invokes the `genxlt` utility, which reads the character conversion information and produces the conversion table. It can be invoked under VM/CMS or z/VM batch. For information on the `genxlt` utility, see *XL C/C++ for z/VM: User's Guide*.

Running Your Application

You can run an application under z/VM after you have issued one of the following commands:

- LOAD (Stores a copy of the program in virtual storage)
- GENMOD (Stores the program on disk)
- LKED (Stores the program in a LOADLIB)
- BIND (Stores the program on disk using the Program Management binder)

routine in the application. The run-time options and program parameters are normally separated by a slash but C/C++ and PL/I users must omit the slash (unless it is part of a program parameter) if the NOEXECOPS run-time option is in effect.

Program parameters should be enclosed in single quotation marks since run-time parameters pass special characters.

For example, if you wanted to run a C or PL/I program named PROGRAM1, and you wanted to specify the RPTSTG(ON) and RPTOPTS(ON) run-time options, you would issue the following commands:

```
FILEDEF SYSLIB DISK SCEELKED TXTLIB E
LKED PROGRAM1 (NAME PROGRAM1 LIBE USERLOAD
GLOBAL LOADLIB SCEERUN USERLOAD
OSRUN PROGRAM1 PARM='RPTSTG(ON),RPTOPTS(ON)/'
```

Using the VM/CMS Extended Parameter List

When z/VM transfers control to an application, the CMS extended parameter list is used to construct the main routine's parameters and get run-time options. Language Environment repackages the CMS extended parameter list according to the format indicated in *z/OS: Language Environment Programming Guide*. Under Language Environment:

- An application with a COBOL main program receives the CMS extended parameter list as a halfword-prefixed string.
- An application with a C/C++ main routine receives the CMS extended parameter list in an argc, argv format.
- If your PL/I application specifies SYSTEM(CMS), you receive the CMS extended parameter. If your application specifies SYSTEM(CMSTPL), however, it receives the CMS tokenized parameter list.

Running under z/VM

Chapter 3. Building, Loading, and Running under OpenExtensions

The interface to the CMS module build facilities for OpenExtensions C/C++ applications is the OpenExtensions c89 utility. You can use c89 to compile and build an OpenExtensions C/C++ program in one step, or bind application object modules after the compilation. You can run the c89 utility from either the OpenExtensions shell or directly from CMS. For more information on using the c89 utility, see *z/VM: OpenExtensions Commands Reference*.

Note: VisualAge PL/I routines are not supported under OpenExtensions. Therefore the PL/I information in this chapter applies only to earlier versions of PL/I.

PL/I for MVS & VM routines are supported under OpenExtensions. PL/I for MVS & VM routines can run in the IPT without any unique restrictions other than those described in *PL/I for MVS & VM Compiler and Run-Time Migration Guide*. PL/I routines can run in the non-initial thread (non-IPTs) created by C routines with some restrictions. Limited PL/I – C ILC is supported in non-IPTs.

Basic Building and Running C/C++ Applications under OpenExtensions

OpenExtensions supports the following environments for running your OpenExtensions C/C++ applications:

- OpenExtensions shell
- CMS

Using the OpenExtensions-supplied utility c89, you can compile and build an OpenExtensions C/C++ application in one step, or bind application object modules separately. To produce an executable file, invoke c89 and pass it object modules (*file.o* BFS files or CMS native files) without using the *-c* option. For information on the c89 utility, see *z/VM: OpenExtensions Commands Reference*.

Invoking the OpenExtensions Shell

To begin a shell session, you first log on to z/VM as a CMS user and then invoke the shell with the OPENVM SHELL command. The shell and all processes and process groups running under it are typically in the same session. For more information about starting a shell session, see *z/VM: OpenExtensions Commands Reference*.

Using the OpenExtensions c89 Utility to Create Executable Files

To build an OpenExtensions C/C++ application program's object files to produce an executable file, specify the c89 utility and pass it object files (*file.o* BFS (byte file system) files or CMS native files). The c89 utility recognizes that these are object files produced by previous C/C++ compilations and does not invoke the compiler for them.

To compile source files without binding them, use the c89 *-c* option to create object files only. You can use the *-o* option with the command to specify the name and location of the application program executable file to be created.

Running under OpenExtensions Services

- To build an application program object file to create the default executable file `a.out` in the working directory, specify:

```
c89 usersource.o
```

- To build an application object file to create the `mymod.out` executable file in the `app/bin` directory, relative to your working directory, specify:

```
c89 -o app/bin/mymod.out usersource.o
```

where `usersource.o` is the object file created by compilation with `c89`.

- To build several application object files to create the `mymod.out` executable file in the `app/bin` directory, relative to your working directory, specify:

```
c89 -o app/bin/mymod.out usersrc.o othersrc.o
```

- To build an application object file to create the `myloadmd` module file on the A disk specify:

```
c89 -o //myloadmd.module usersource.o
```

- To compile and build an application source file with several `zinfo` in the `approg/lib` subdirectory, relative to your working directory, specify:

```
c89 -o approg/lib/zinfo usersrc.c existobj.o //pgmobj.module
```

The `c89` utility specifies default values for some prelinker and module build options. It also passes prelinker and module build options by using the `-W` option. For more information on using the `c89` options, see *z/VM: OpenExtensions Commands Reference*.

Prelinker Options

With the exception of the `OE` option described below, the other prelinker options are the same as described in Appendix A, “Prelinking an Application,” on page 93.

OEINOOE

The `OE` option causes the prelinker to change its processing of `INCLUDE` and `LIBRARY` control statements.

Object files and object libraries from `c89` are passed to the prelinker via `INCLUDE` and `LIBRARY` control statements, respectively, in its primary input. Only `LIBRARY` control statements included in primary input are accepted by the prelinker. Their syntax is:

```
LIBRARY libname
```

where *libname* is a `ddname` that defines a library. The library can be either an archive file created through the OpenExtensions `ar` utility, or a `C370LIB` text library with object modules as members. Object libraries from `c89` are passed to the prelinker using such statements. This provides a capability that is best described as named `SYSLIBs`. These statements are used like `SYSLIBs` to resolve symbols through autocalls, but they do not all have to be concatenated together as a `SYSLIB`. `BFS` files cannot be concatenated.

When the `OE` option is specified, the prelinker accepts `BFS` files and `CMS` files on `INCLUDE` and `LIBRARY` control statements.

The `OE` option causes the prelinker to use `POSIX` rules for processing its primary input; the order of passed object files and object libraries and their interspersions is significant. The prelinker’s primary input is processed sequentially. When a primary input `INCLUDE` control statement is processed, the prelinker accepts new defined and unresolved symbols occurring in the passed object file. When a primary input `LIBRARY` control statement is processed, only currently unresolved symbols are

searched for in the passed object library. A library is processed once only even if it contains definitions of unresolved symbols that are accepted during later processing.

RENAME control statements are processed on output from the prelinker, after all of its input has been processed. Because a library can be processed once only, the SEARCH option on the RENAME control statement has no effect.

Specifying Run-Time Options under OpenExtensions

If you have an OpenExtensions C/C++ application program executable file in the byte file system (BFS), you cannot run the executable file by simply entering its name as you would a traditional CMS C/C++ application program. Instead, execute the C/C++ application by specifying its name on the CMS command OPENVM RUN. However, OPENVM RUN does not support the specification of run-time options.

Run-time options needed for the OpenExtensions application program residing in the byte file system can be passed from a `#pragma runopts` preprocessor directive at compile time. When run-time options are specified in this way, a CEEUOPT control section (CSECT) is created and is linked with the application program by the `c89` utility. Because only one CEEUOPT CSECT can be linked with an application program, you should code a `#pragma runopts` directive in the compilation unit for the `main()` function.

Also, you can create a CEEUOPT CSECT as a separate step using the CEEXOPT macro, and bind the CSECT with the application program object files using `c89`.

Running under OpenExtensions

This section discusses how to run your OpenExtensions C/C++ application program executable files on the z/VM system.

OpenExtensions Application Program Environments

OpenExtensions for z/VM supports the following environments, from which you can run your OpenExtensions C/C++ application programs:

- OpenExtensions shell
- CMS

Placing a CMS Application Program Load Module in the File System

If you have an OpenExtensions C/C++ application program executable file as a CMS native file and want to place it in the BFS, use the following OpenExtensions CMS command to copy the file into a BFS file: `openvm putbfs`. For a description of this command, see *z/VM: OpenExtensions Commands Reference*. For examples of using commands to copy CMS files into BFS, see *z/VM: OpenExtensions User's Guide*.

Running a CMS Module from the OpenExtensions Shell

If your OpenExtensions C/C++ program is a CMS module file on a minidisk or in the shared file system, the only way you can invoke it from the shell is by creating an external link in BFS that points to the file. For example, if you need to execute `PROG1 MODULE A`, you can create a file in BFS that represents it by using the following command:

```
openvm create extlink /u/mydir/prog cmsexec prog1 module a
```

Running under OpenExtensions Services

You can then invoke the module directly from the shell by entering prog assuming that /u/mydir is in the current PATH.

See *z/VM: OpenExtensions Commands Reference* for more information on creating external links.

Running an OpenExtensions C/C++ Application Executable File from the OpenExtensions Shell

If the application executable file is a BFS file, you must either run it from the shell interactively, or invoke it indirectly through the CMS command OPENVM RUN.

Issuing the Executable File Name from the Shell

Before a BFS program can be run in the OpenExtensions shell, it must be given the appropriate mode authority for a user or group of users to run it. You can update the mode authority for an executable program file by using the chmod command, which is described in *z/VM: OpenExtensions Commands Reference*.

After you have update mode authority, enter the program name from the OpenExtensions shell command line. For example, if you want to run the program data_crunch from your working directory, you have the directory where the program resides defined in your search path, and you are authorized to run the program, enter:

```
data_crunch
```

When running such programs, you can specify invocation run-time options only by setting the environment variable _CEE_RUNOPTS before invoking the program. For example, under the shell you can use the following EXPORT command:

```
EXPORT _CEE_RUNOPTS="rpto(on)..."
```

To further update the run-time options, you need to issue another EXPORT.

Issuing a Setup Shell Script File Name from the Shell

To run an OpenExtensions shell script that sets up an OpenExtensions executable file and then runs the program, give the appropriate mode authority for a user or group of users to run it. You can update the mode authority for a shell script file by using the chmod command (see *z/VM: OpenExtensions Commands Reference*). After mode authority has been given, enter the script file name from the OpenExtensions shell command line.

Basic Building and Running PL/I routines under OpenExtensions

When the run-time option POSIX(ON) is specified, PL/I routines in the Initial Process Thread (IPT) follow the same rules and behave in the same way they do when POSIX(ON) is not in effect.

PL/I routines in non-IPTs, however, must follow the rules described in *z/OS: Language Environment Programming Guide*. No run-time diagnosis is provided to enforce those rules.

Chapter 4. Initialization and Termination under Language Environment

This chapter describes z/VM considerations when calculating the Language Environment enclave return code. For additional information regarding initialization and termination under Language Environment, see *z/OS: Language Environment Programming Guide*.

How the Language Environment Enclave Return Code Is Calculated

When an enclave terminates, Language Environment provides a Language Environment enclave return code and an enclave reason code (sometimes called a return code modifier). The Language Environment enclave return code is calculated by summing the user return code generated by the HLL and the enclave reason code as follows:

Language Environment enclave return code = user return code + enclave reason code

The Language Environment enclave return code is placed in register 15, and the enclave reason code is placed in register 0.

For information on setting and altering user return codes and calculating the enclave reason code, see *z/OS: Language Environment Programming Guide*.

z/VM Considerations

The CMS Ready(XXXXX) prompt displays only the last 5 digits of the enclave return code. Under VM, some enclave return codes containing more than 5 digits (for example, 2,000,000 or 3,000,000) are **not** displayed. In this case, the CMS Ready prompt indicates the following:

```
Ready(00000);
```

When a negative number is returned that is greater than 4 digits, only the last 4 digits are displayed. For example, if the return code is -65280, only -5280 is displayed.

You can write a simple REXX EXEC to retrieve the complete enclave return code. The following example extracts the return code and issues a message based on its value:

```
/* */
'LEMOD' /* Run the Language Environment program */
LE_RC = Rc /* Save the Language Environment enclave return code */
If LE_RC ^= 0 Then Do
  Say 'Nonzero Language Environment enclave return code: ' LE_RC
  Exit 16
End /* nonzero rc from Language Environment */
Else
  Exit 0
```

Initialization and Termination

Chapter 5. Using and Handling Messages

This chapter describes z/VM considerations for using Language Environment message services to create, issue, and handle messages for Language Environment-conforming applications.

For more information on using and handling Language Environment messages, see *z/OS: Language Environment Programming Guide*.

Creating Messages

The following sections explain how to create messages to use in your routines. To create a message, you:

1. Create a message source file
2. Convert the message source file to an ASSEMBLE file with the CEEBLDTX utility
3. Assemble the new message ASSEMBLE file
4. Create a message module table
5. Assign values to message inserts
6. Use messages in code to get message output

Creating a Message Source File

The message source file contains the message text and information associated with each message. Standard tags and format are used for message text and different types of message information. The tags and format of the message source files are used by the CEEBLDTX utility to transform the source file into an ASSEMBLE file.

A file type of SCRIPT is assumed for the source file and the file mode defaults to A. The message source file should have a fixed record format with a record length of 80.

When creating a message file, make sure your sequential numbering attribute is turned off in the editor so that trailing sequence numbers are not generated. Trailing blanks in columns 1–72 are ignored. At least one message file is required for each national language version of your messages.

All tags used to create the source file begin with a colon(:), followed by a keyword and a period(.). All tags must begin in column 1, except where noted. Comments in the message source file must begin with a period asterisk (.*) in the leftmost position of the input line.

Figure 1 on page 30 shows an example of a message source file with a facility ID of XMP.

```
:facid.XMP
:msgno.10
:msgsubid.0001
:msgname.EXPLMSG
:msgclass.I
:msg.This is an example of an insert,
:tab.+1
:ins 1.a simple insert
:msg., within a message.
:xpl.This is a simple example of how to put an insert into a message.
:presp.No programmer response required.
:sysact.No system action is taken.
```

Figure 1. Example of a Message Source File

For more information on creating Language Environment messages, see *z/OS: Language Environment Programming Guide*.

Using the CEEBLDTX Utility

CEEBLDTX is a utility that transforms the message source file into an ASSEMBLE file that can then be assembled and loaded. The syntax of the CEEBLDTX invocation is shown below.

This utility only runs in a regular CMS environment, not in the the OpenExtensions Shell & Utilities environment.

►►—CEEBLDTX—*in_file*—*out_file*—*options*—◄◄

in_file

The file name of the SCRIPT file containing the message text source.

out_file

The file name of the resulting ASSEMBLE file containing the text version of the messages.

options

Can be omitted or be any of the following:

C370(*filename*)
COBOL(*filename*)
PLI(*filename*)
BAL(*filename*)

COBOL options only:

- APOST
- QUOTE

APOST/QUOTE specifies which COBOL delimiter to use. APOST is the default.

filename

Specifies the name of the file to contain the condition tokens for the messages supplied in *in_file* in the format requested by the option(s) specified above.

Filename has the following default file types based on the specified language:

H	For C
COPY	For COBOL
COPY	For PL/I
COPY	For BAL

Usage Notes:

1. Each parameter is positional. Every parameter, except the *options* parameter, is required.
2. Under z/VM an equal sign (=) can be substituted for any parameter, except for *in_file*. Parameters represented by an equal sign (=) are equated with the corresponding parameter previously used.

Files Created by CEEBLDTX

The CEEBLDTX utility creates several files. The ASSEMBLE file can be assembled into a loadable text file. When the name of this file is placed in a message module table, the Language Environment message services can dynamically access the file. See *z/OS: Language Environment Programming Guide* for more information about creating a message module table.

The COPY or INCLUDE file contains the declarations for the condition tokens associated with each message in the message source file. When this file is included in the source routine, the condition tokens can be used to reference the message. The *:msgname.* tag indicates the symbolic name of the condition token.

To use the CEEBLDTX utility with the sample file shown in Figure 1 on page 30 you would issue:

```
CEEBLDTX example exmplasm pli(exmplcop)
```

The *in_file* is EXAMPLE SCRIPT, the *out_file* is EXMPLASM ASSEMBLE, and the PL/I COPY file is EXMPLCOP COPY.

Use High Level Assembler to assemble the ASSEMBLE file into a loadable TEXT file; for example, on z/VM you can issue the command:

```
HLASM exmplasm
```

CEEBLDTX Error Messages

The following is a list of Language Environment CEEBLDTX errors. For more information on CEEBLDTX errors, see *z/OS: Language Environment Programming Guide*.

Return Code=0004 syntax error

Explanation: The command entered contained a syntax error.

Programmer response: Correct the syntax error and reissue the command.

Return Code=0028 ssssssss SCRIPT not found on any accessed disk.

Explanation: The SCRIPT file with the name ssssssss does not exist.

Programmer response: Make sure the name is given correctly and is accessible.

Return Code=0036 Disk A must be accessed as Read/Write.

Explanation: On VM, the A-disk must be writable to write the outfile files.

Programmer response: Specify an A-disk that is write accessible.

Return Code=0040 Error on line nnn in message nnnn - insert number greater than mmmm.

Explanation: An insert number greater than the allowable maximum was specified. The current maximum allowable insert number is 9.

Programmer response: Specify an insert number of 9 or less.

Return Code=0044 Error on line nnn - Duplicate :FACID. tags found within the given script file.

Explanation: Only one facility ID can be specified in the SCRIPT file.

Using Messages

Programmer response: Specify only one facility ID in the SCRIPT file.

Return Code=0048 No :FACID. found within the given script file.

Explanation: A 3-character facility ID must be specified in the SCRIPT file with the :facid. 31 tag.

Programmer response: Specify a 3-character facility ID with the :facid. 33 tag.

Return Code=0052 Error on line nnn - Message number nnnn found out of range mmmm to mmmm.

Explanation: A message was found with a number outside the valid range. 36 The current valid range is 0 to 9999.

Programmer response: Correct the invalid message number on the given line of the SCRIPT file.

Return Code=0056 Error on line nnn in message mmmm - number of hex digits not divisible by 2

Explanation: Hexadecimal strings must contain an even number of digits.

Programmer response: Specify an even number of digits for the hexadecimal string.

Return Code=0060 Error on line nnn in message mmmm - invalid hexadecimal digits

Explanation: Valid hexadecimal digits are 0-9 and A-F. 43 Invalid digits were detected.

Programmer response: Specify only digits 0-9 and A-F within a hexadecimal string.

Return Code=0064 Error on line nnn in message mmmm - number of DBCS bytes not divisible by 2

Explanation: Doublebyte character strings must contain an even number of bytes.

Programmer response: Specify an even number of bytes for the doublebyte character string.

Return Code=0068 ASSEMBLE out_file name must be longer than the message facid pppp.

Explanation: The ASSEMBLE file name must be greater than 3 characters.

Programmer response: Specify an ASSEMBLE out_file name of greater than 3 characters.

Return Code=0072 Error on line nnn - message facid pppp longer than 4 characters.

Explanation: Facility ID must be exactly 3 characters long, with no blanks.

Programmer response: Specify a 3-character facility ID.

Return Code=0076 Error on line nnn - message class class is not a valid message class type: IWESCFA.

Explanation: Message class must be one of the valid message classes.

Programmer response: Specify a valid message class.

Return Code=0080 Error on line nnn - tag not recognized

Explanation: A tag that was not recognized was encountered.

Programmer response: Check the tag for proper spelling and use.

Return Code=0084 Error on line nnn - first tag not :FACID.

Explanation: The first tag of the SCRIPT file must be the facility ID tag.

Programmer response: Specify the facility ID tag as the first tag in the SCRIPT file.

Return Code=0088 Error on line nnn - unexpected tag.

Explanation: A valid tag was found in an unexpected location in the SCRIPT file; it is likely out of order.

Programmer response: Check the order of the tags in the SCRIPT file.

Return Code=0092 Error on line nnn in message mmmm - duplicate errortag tags

Explanation: Duplicate :msgname., :msgclass., or :msgsubid. tags were found for a single message.

Programmer response: Remove the extra tag from the message script.

Return Code=0096 No :MSGNO. tags found within the given script file.

Explanation: A message file must have at least one message in it, and it must be denoted by a :msgno. tag.

Programmer response: Specify at least one message in the message file.

Return Code=0100 Error on line nnn in message mmmm - insert number not provided or less than 1

Explanation: A positive insert number must be provided for each insert.

Programmer response: Specify a positive insert number of 9 or less for the insert.

Return Code=0104 Error on line nnn in message mmmm - subid msgkey found out of range of mmmm to mmmm.

Explanation: A message subid was found with a number outside the valid range. The current valid range is 0 to 9999.

Programmer response: Correct the invalid message subid on the given line of the SCRIPT file.

Return Code=0108 Existing filename COPY file found, but not on A-disk.

Explanation: A feedback token file was found with the

given name, but it is not on the A-disk, and will not be replaced.

Programmer response: Specify a different feedback token file name, or release the disk on which the file currently resides

Return Code=0112 Current ADDRESS environment not CMS or TSO.

Explanation: The command was entered on a system other than CMS or TSO/E.

Programmer response: Issue the command on a supported system.

Return Code=nnn Undefined error number nnn issued.

Explanation: An undefined error was encountered.

Programmer response: Contact your service representative.

Run-Time Messages with POSIX

When your C application is running with POSIX(ON), some messages have changed both facility ID and message number. Messages that had a facility ID of EDC and ranged from message number 6000 through 6008 prior to running with POSIX(ON) now have a facility ID of CEE and use message numbers 5201 through 5209. Messages 5210 through 5233 are new for POSIX(ON) and thus do not have a corresponding POSIX(OFF) message number, except for message 5223, which has a facility ID of EDC and a message number of 6009 while running with POSIX(OFF). When your C application is running with POSIX(OFF), facility ID EDC is still used for message numbers 6000 through 6009.

If your C application is coded to respond to specific facility IDs or specific message numbers for processing, you must specify POSIX(OFF) to receive the facility ID of EDC and message numbers 6000 through 6009.

Table 4 shows the conditions, their condition numbers, and facility IDs.

Table 4. Condition Tokens with POSIX

Condition Token	Facility ID with POSIX(ON)	Message Number with POSIX(ON)	Facility ID with POSIX(OFF)	Message Number with POSIX(OFF)
SIGFPE	CEE	5201	EDC	6000
SIGILL	CEE	5202	EDC	6001
SIGSEGV	CEE	5203	EDC	6002
SIGABND	CEE	5204	EDC	6003
SIGTERM	CEE	5205	EDC	6004
SIGINT	CEE	5206	EDC	6005
SIGABRT	CEE	5207	EDC	6006
SIGUSR1	CEE	5208	EDC	6007

Run-Time Messages with POSIX

Table 4. Condition Tokens with POSIX (continued)

Condition Token	Facility ID with POSIX(ON)	Message Number with POSIX(ON)	Facility ID with POSIX(OFF)	Message Number with POSIX(OFF)
SIGUSR2	CEE	5209	EDC	6008
SIGHUP	CEE	5210	na	na
SIGSTOP	CEE	5211	na	na
SIGKILL	CEE	5212	na	na
SIGPIPE	CEE	5213	na	na
SIGALRM	CEE	5214	na	na
SIGCONT	CEE	5215	na	na
SIGCHLD	CEE	5216	na	na
SIGTTIN	CEE	5217	na	na
SIGTTOU	CEE	5218	na	na
SIGIO	CEE	5219	na	na
SIGQUIT	CEE	5220	na	na
SIGTSTP	CEE	5221	na	na
SIGTRAP	CEE	5222	na	na
SIGIOERR	CEE	5223	EDC	6009
SIGDCE	CEE	5224	na	na

Handling Message Output

The following sections provide information about directing message output and displaying messages under Language Environment, C, C++, COBOL, and PL/I.

For information about handling message output in ILC applications, see *z/OS: Language Environment Writing ILC Applications*.

Using Language Environment MSGFILE

Run-time messages are directed to a common Language Environment message file. You can use the MSGFILE run-time option to specify the ddname of this file. If a message file ddname is not declared, messages are written to the IBM-supplied default ddname SYSOUT.

Table 5 lists the SYSOUT definitions and MSGFILE default attributes for CMS:

Table 5. Operating System, SYSOUT Definitions, MSGFILE Default Attributes

Operating System	SYSOUT Definition	MSGFILE Default Attributes
CMS	FILEDEF SYSOUT TERMINAL	LRECL 121, BLKSIZE 121, RECFM FBA, ¹ NOCHANGE

Notes:

1. When output is directed to the terminal, ASA control characters are replaced by a single space.

When you direct run-time messages to an I/O device, the method you should use also depends on the operating system. Table 6 lists methods for directing run-time messages to an I/O device under CMS and provides references for additional information on this topic.

Table 6. Defining an I/O Device for a ddname

Operating System	Method to Define I/O Device	For additional information, see:
CMS	Use a FILEDEF statement to define a ddname for a file.	“Using FILEDEF to Define Input and Output Files” on page 14

Note: You can specify the same message file across nested enclaves.

Using MSGFILE under OpenExtensions

If your application is running under the OpenExtensions shell or any environment that has file descriptor 2 (FD2) open, MSGFILE output is directed to the FD2 print destination. Under the shell, this is typically your terminal. If FD2 is closed when your application is invoked (via `spawn()` or `exec()`), no message file is created.

For dump services, the resulting file name has the following format:

`/path/Fname.Date.Time.Pid`

path The current working directory (unless it is the working directory, in which case it is then `/tmp`).

Fname

The name specified in the FNAME parameter on the call to CEE3DMP (default is CEEDUMP).

Date The date the dump is taken, appearing in the format YYYYMMDD (such as 20030325 for March 25, 2003).

Time The time the dump is taken, appearing in the format HHMMSS (such as 175501 for 05:55:01 PM).

Pid The process ID the application is running in when the dump is taken.

Using C or C++ I/O Functions

C and C++ make a distinction between types of error output, and whether the output is directed to the MSGFILE destination or to one of the standard stream output devices, `stderr` or `stdout`.

Run-time messages and `perror()` messages are directed to the `stderr` standard stream output device. The default destination for `stderr` output is the MSGFILE ddname; you can change this default as discussed below.

Message output issued by a call to the `printf()` function is directed to `stdout`. For CMS interactive, `stdout` defaults to the terminal.

You can change the destination of `printf()` output by redirection. For example, `1>&2` on the command line at routine invocation redirects `stdout` to the `stderr` destination.

Table 7 on page 36 lists the types of C/C++ output, the types of messages associated with them, and the destination of the message output.

Handling Message Output

Table 7. C and C++ Message Output

Type of Output	Type of Message	Produced By	Default Destination
MSGFILE output	Language Environment messages (CEExxxx)	Language Environment unhandled conditions	MSGFILE ddname
	C library messages	C/C++ unhandled conditions (EDCxxxx)	MSGFILE ddname
stderr messages	perror() messages (EDCxxx)	Issued by a call to perror()	MSGFILE ddname
	User output sent explicitly to stderr	Issued by a call to fprintf()	MSGFILE ddname
stdout messages	User output sent explicitly to stdout	Issued by a call to printf()	stdout

You can control the destination of stderr and stdout output by using the Language Environment MSGFILE run-time option, the C freopen() function, or by invoking redirection services at run time.

Table 8 lists the possible destinations of redirected stderr and stdout standard stream output.

Table 8. C/C++ Redirected Stream Output

	stderr not redirected	stderr redirected to destination other than stdout	stderr redirected to stdout
stdout not redirected	stdout to itself	stdout to itself	Both to stdout
	stderr to MSGFILE	stderr to its other destination	
stdout redirected to destination other than stderr	stdout to its other destination	stdout to its other destination	Both to the other stdout destination
	stderr to MSGFILE	stderr to its other destination	
stdout redirected to stderr	Both to MSGFILE	Both to the other stderr destination	When stderr and stdout are redirected to each other (this is not recommended), output from both is directed to whichever was specified first.

For more information about redirecting standard streams in C or C++, see *XL C/C++ for z/VM: User's Guide*.

Using COBOL I/O Statements

Language Environment manages all COBOL output directed to the system-logical output device. This includes output from:

- DISPLAY ... UPON SYSOUT
- READY TRACE (OS/VS COBOL only)
- EXHIBIT (OS/VS COBOL only)

For COBOL programs, the DISPLAY statement sends output to MSGFILE(SYSOUT), the default ddname for the Language Environment message file. You can use the COBOL OUTDD compiler option to change the destination of DISPLAY output. The CMS file to which the run-time messages are written depends on the combination of ddnames specified in the OUTDD compiler option and the MSGFILE run-time option.

If the ddname in OUTDD matches the ddname specified in the MSGFILE run-time option, the output is synchronized with the run-time messages and placed in the CMS file designated by the MSGFILE run-time option.

If the ddname in OUTDD does not match the ddname specified in the MSGFILE run-time option, the output from the DISPLAY statement is directed to the OUTDD ddname destination.

If the file designated by MSGFILE has not been defined (associated with an I/O device) when the output is delivered, Language Environment dynamically allocates the file with ddname and attributes as shown in Table 5 on page 34.

If the file designated by OUTDD has not been defined when the output is delivered, Language Environment dynamically allocates the file with ddname and attributes as shown in Table 5 on page 34.

The possible ddname specification combinations for OUTDD and MSGFILE and the locations where display output and run-time messages are routed are summarized in Table 9 on page 38.

Handling Message Output

Table 9. Run-time Message and DISPLAY Destinations for OUTDD and MSGFILE ddname Specifications under VM

ddname Specification	FILEDEFS Issued?	Destination
MSGFILE(SYSOUT) OUTDD(SYSOUT)	Yes, for SYSOUT	Messages and DISPLAY data are routed to the destination defined for SYSOUT.
	No	Language Environment dynamically allocates FILEDEF SYSOUT TERM for messages and DISPLAY data.
MSGFILE(SYSOUT) OUTDD(ddname)	Yes, for SYSOUT	Messages are routed to the destination defined for SYSOUT.
	Yes, for ddname	DISPLAY data is routed to the destination defined for ddname.
	No	Language Environment dynamically allocates SYSOUT to FILEDEF SYSOUT TERM, the message destination. Language Environment dynamically allocates ddname to FILEDEF ddname DISK FILE ddname A1, the DISPLAY data destination.
MSGFILE(ddname) OUTDD(SYSOUT)	Yes, for ddname	Messages are routed to the destination defined for ddname.
	Yes, for SYSOUT	Display data is routed to the destination defined for SYSOUT.
	No	Language Environment dynamically allocates ddname to FILEDEF ddname TERM, the message destination. Language Environment dynamically allocates SYSOUT to FILEDEF SYSOUT DISK FILE SYSOUT A1, the DISPLAY data destination.

For more information about directing COBOL output, refer to *COBOL for OS/390 & VM Programming Guide* or *COBOL for MVS & VM Programming Guide*.

Using PL/I I/O Statements

Run-time messages in PL/I routines are directed to the file specified by the Language Environment MSGFILE run-time option, instead of to the PL/I SYSPRINT STREAM PRINT file.

User-specified output is still directed to the PL/I SYSPRINT STREAM PRINT file by default. To direct this output to the Language Environment MSGFILE file, specify the run-time option MSGFILE(SYSPRINT).

When you use MSGFILE(SYSPRINT):

- Any file constant declaration that includes SYSPRINT STREAM PRINT file attributes is ignored.
- File attributes specified in the SYSPRINT DD card or FILEDEF are used.

- If SYSPRINT DD or FILEDEF is not present at first file reference, Language Environment dynamically allocates a file with IBM-supplied attributes. See Table 5 on page 34 for MSGFILE file default attributes.
- Any OPENs and CLOSEs to the PL/I SYSPRINT STREAM PRINT file are ignored.
- Synchronization between the types of output (messages and user-specified output) is not provided, so the order of the output is unpredictable.

MSGFILE Considerations When Using PL/I

If MSGFILE(SYSPRINT) is in effect, use SYSPRINT only to direct output to the PL/I SYSPRINT STREAM PRINT file.

Because performance is slower with the MSGFILE(SYSPRINT) option, it is recommended only for debugging purposes. For production applications, direct user-created output to the PL/I SYSPRINT STREAM PRINT file.

In a nested enclave environment, you can specify MSGFILE(SYSPRINT) for all enclaves in the application or only for those enclaves containing PUT statements. Multiple enclaves in a Language Environment process can use the PL/I SYSPRINT STREAM PRINT. In this instance, you cannot open the file until it is referenced, and it is closed by Language Environment at process termination.

For more information about directing PL/I output, refer to *z/OS: Language Environment Writing ILC Applications* or *PL/I for MVS & VM Programming Guide*.

Chapter 6. Using Run-Time User Exits

Language Environment provides user exits that you can use for functions at your installation. You can use the assembler user exit (CEEEXITA) or the HLL user exit (CEEEXINT). This chapter provides z/VM specific information about using these run-time user exits. For more information on using run-time user exits, see *z/OS: Language Environment Programming Guide*.

Understanding the Basics

User exits are invoked under Language Environment to perform enclave initialization functions and both normal and abnormal termination functions. User exits offer you a chance to perform certain functions at a point where you would not otherwise have a chance to do so. In an assembler initialization user exit, for example, you can specify a list of run-time options that establish characteristics of the environment. This is done prior to the actual execution of any of your application code.

In most cases, you do not need to modify any user exit in order to run your application. Instead, you can accept the IBM-supplied default versions of the exits, or the defaults as defined by your installation. To do so, run your application in the normal manner and the default versions of the exits are invoked. You might also want to read the sections “User Exits Supported under Language Environment” and “When User Exits Are Invoked” on page 43, which provide an overview of the user exits and describe when they are invoked.

If you plan to modify either of the user exits to perform some specific function, you must link the modified exit to your application before running. In addition, the *z/OS: Language Environment Programming Guide* describes the respective user exit interfaces to which you must adhere in order to change an assembler or HLL user exit.

User Exits Supported under Language Environment

Language Environment provides two user exit routines, one written in assembler (CEEEXITA), and the other in a Language Environment-conforming language (CEEEXINT). You can find sample jobs containing these user exits in the SCEESAMP sample library.

The user exits supported by Language Environment are shown in Table 10.

Table 10. User Exits Supported under Language Environment

Name	Type of User Exit	When Invoked
CEEEXITA	Assembler user exit	Enclave initialization Enclave termination Process termination
CEEEXINT	HLL user exit. CEEEXINT can be written in C, C++ (with C linkage), PL/I or Language Environment-conforming assembler.	Enclave initialization

When CEEEXITA or CEEEXINT is linked with the Language Environment initialization/termination library routines during installation, it functions as an installation-wide user exit. When CEEEXITA is linked in your load module, it

Run-Time User Exits

functions as an application-specific user exit. The application-specific exit is used only when you run that application. The installation-wide assembler user exit is not executed.

When your version of CEEBINT is linked with the Language Environment library routines during installation, this version is automatically used at link-edit time for newly built or relinked applications. A new version of CEEBINT will require you to relink your application.

To use an application-specific user exit, you must explicitly include it at link-edit time in the application load module using a CMS INCLUDE command (see “Using the INCLUDE Command” on page 12 for more information). Any time that the application-specific exit is modified, it must be relinked with the application.

For a description of the assembler user exit interface and the HLL user exit interface, see *z/OS: Language Environment Programming Guide*.

PL/I and C Compatibility

The following OS PL/I Version 2 Release 3 user exit is supported for compatibility under Language Environment:

- IBMBXITA (VM version)

For information about IBMBXITA and IBMBINT, see *PL/I for MVS & VM Compiler and Run-Time Migration Guide*, and *z/OS XL C/C++ Programming Guide*.

Default versions of these user exits are not supplied under Language Environment; instead, Language Environment supplies a default version of CEEBXITA.

Table 11 describes the order of precedence if the IBMBXITA and IBMFXITA user exits are found in the same root load module with CEEBXITA.

Table 11. Interaction of Assembler User Exits

CEEBXITA Present	IBMBXITA Present under OS/390 Batch or VM, IBMFXITA Present under CICS®	Exit Driven
No	No	Default version of CEEBXITA
Yes	No	CEEBXITA
No	Yes	IBMBXITA
Yes	Yes	CEEBXITA

Using Sample Assembler User Exits

You can use the sample assembler user exit programs distributed with Language Environment to modify the code for the requirements of your application. Choose a sample program appropriate for your application. The following assembler user exit programs are delivered with Language Environment:

Table 12. Sample Assembler User Exits for Language Environment

Example User Exit	Operating System	Where Found	Language (if Language-Specific)
CEEBXITB	z/VM (default)	CEEBXITB ORIGINAL	

If you install Language Environment at your site without modifying it, your system default is CEEBXITB. You can find the source code for CEEBXITB on the z/VM disk where Language Environment is installed with the name CEEBXITB ORIGINAL.

The assembler user exit CEEBXITA performs functions for enclave initialization, normal and abnormal enclave termination, and process termination. CEEBXITA must be written in assembler language, because an HLL environment might not be established when the exit is invoked.

You can set up user exits for tasks such as:

- Installation accounting and charge back
- Installation audit controls
- Programming standard enforcement
- Common application run-time support

When User Exits Are Invoked

Figure 2 shows the timing of the invocations of the user exits at initialization and termination processing.

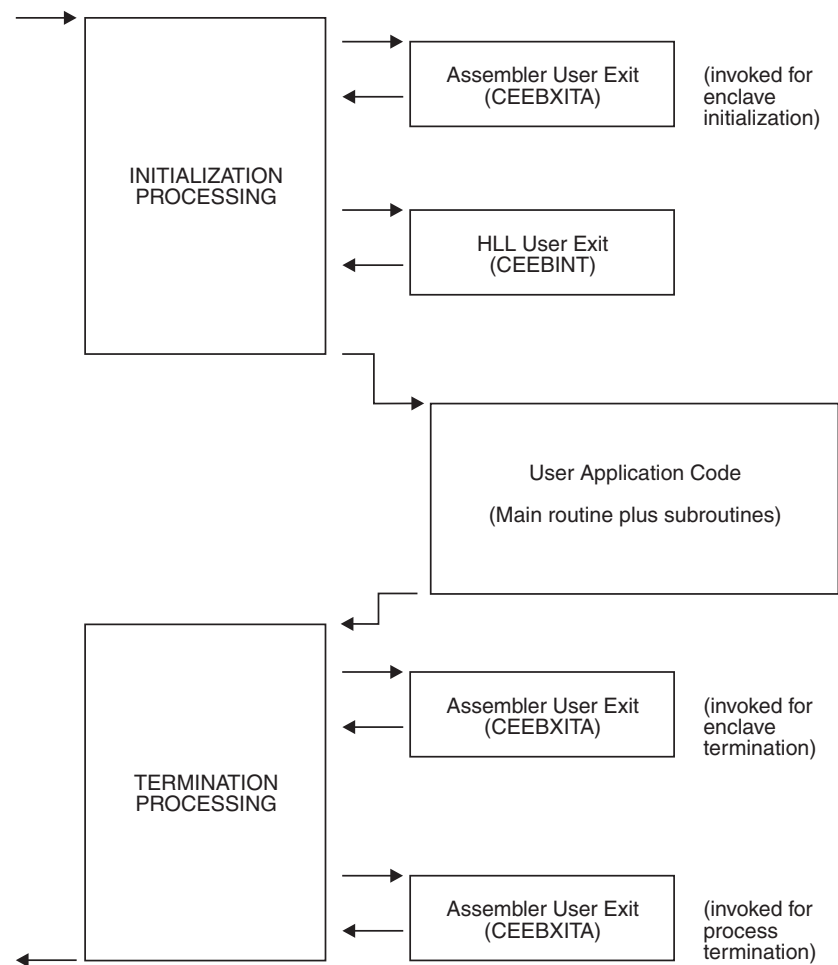

Figure 2. Location of User Exits

In Figure 2, run-time user exits are invoked in the following sequence:

1. Assembler user exit is invoked for enclave initialization.

Run-Time User Exits

2. Environment is established.
3. HLL user exit is invoked.
4. Main routine is invoked.
5. Main routine returns control to caller.
6. Assembler user exit is invoked for termination of the enclave. CEEBXITA is invoked for enclave termination processing after all application code in the enclave has completed, but prior to any enclave termination activity.
7. Environment is terminated.
8. Assembler user exit is invoked for termination of the process. CEEBXITA is invoked again when the Language Environment process terminates.

Language Environment provides the CEEBXITA assembler user exit for termination but does not provide a corresponding HLL termination user exit.

CEEBXITA behaves differently, depending upon when it is invoked, as described in the following sections.

CEEBXITA Behavior During Enclave Initialization

The CEEBXITA assembler user exit is invoked before enclave initialization is performed. You can use CEEBXITA to help establish your application run-time environment. For example, in the assembler user exit you can specify the stack and heap run-time options and allocate data sets. You can also use the user exit to interrogate program parameters and change them if you want. In addition, you can specify run-time options in the user exit by using the CEEAUE_A_OPTIONS field of the assembler interface.

z/VM Considerations

The behavior of the IBM-supplied version of CEEBXITA differs, depending upon whether you are running your application under z/VM or OS/390.

- Under OS/390, CEEBXITA returns control to Language Environment initialization.
- VM only — CEEBXITA issues FILEDEFS for ddnames CEEDUMP, SYSOUT, and SYSIN, then returns control to Language Environment initialization.

Note for C-Specific Installations

This set of FILEDEFS differs from the ones in IBMBXITA that the pre-AD/Cycle version of C used.

CEEBXITA Assembler User Exit Interface

You can modify CEEBXITA to perform any function you need, but the exit must have the following attributes after you modify it at installation:

- The user-supplied exit must be named CEEBXITA.
- The exit must be reentrant.
- The exit must be capable of executing in AMODE(ANY) and RMODE(ANY).
- The exit must be relinked with Language Environment initialization/termination routines after modification.

If a user exit is modified, you are responsible for conforming to the interface shown in Figure 3 on page 45. Note that this user exit **must** be written in assembler. You cannot code CEEBINT as an XPLINK application. However, since CEEBINT is called directly by Language Environment and not the application, a non-XPLINK

CEEBAINT can be statically bound in the same program object with an XPLINK application.

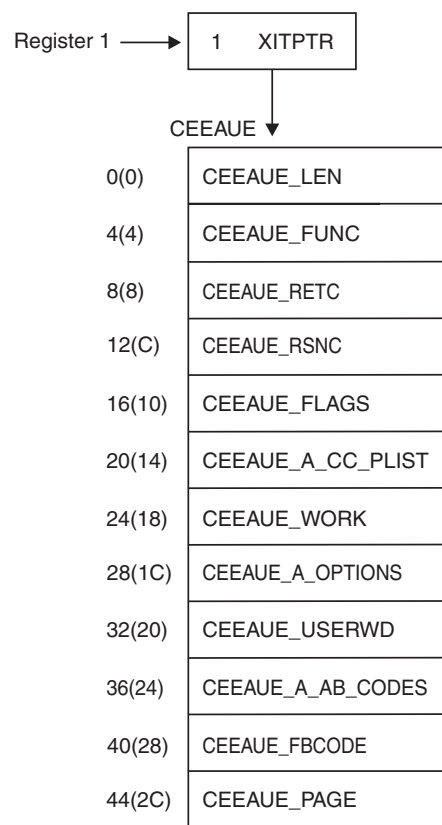

Figure 3. Interface for CEEBXITA Assembler User Exit

When the user exit is called, register 1 points to a word that contains the address of the CEEAE control block. The high-order bit is on.

The CEEAE control block contains the following fullwords:

CEEAE_LEN (input parameter)

A fullword integer that specifies the total length of this control block. For Language Environment, the length is 48 bytes.

CEEAE_FUNC (input parameter)

A fullword integer that specifies the function code. Language Environment supports the following function codes:

- 1 Initialization of the first enclave within a process.
- 2 Termination of the first enclave within a process.
- 3 Nested enclave initialization.
- 4 Nested enclave termination.
- 5 Process termination.

The user exit should ignore function codes other than those numbered from 1 through 5.

CEEAE_RETC (input/output parameter)

A fullword integer that specifies the return or abend code. CEEAE_RETC has different meanings, depending on CEEAE_ABND:

Run-Time User Exits

- If the flag CEEAUE_ABND (see below) is off, this fullword is interpreted as the Language Environment return code placed in register 15.
- If the flag CEEAUE_ABND is on, CEEAUE_RETC is interpreted as an abend code used when an abend is issued. (This could be either an EXEC CICS ABEND or an SVC13.)

CEEAUE_RSNC (input/output parameter)

A fullword integer that specifies the reason code for CEEAUE_RETC:

- If the flag CEEAUE_ABND (see below) is off, this word is interpreted as the Language Environment reason code placed in register 0.
- If the flag CEEAUE_ABND is on, CEEAUE_RETC is interpreted as an abend reason code used when an abend is issued.

This field is ignored when an EXEC CICS ABEND is issued.

CEEAUE_FLAGS

Contains four 1-byte flags. CEEBXITA uses only the first byte but reserves the remaining flags. All unspecified bits and bytes must be 0. The layout of these flags is shown in Figure 4:

Byte 0	x... .. CEEAUE_ABTERM
	0... .. Normal termination
	1... .. Abnormal termination
	.x... .. CEEAUE_ABND
	.0.. .. Terminate with CEEAUE_RETC
	.1.. .. ABEND with CEEAUE_RETC and CEEAUE_RSNC given
	..x. CEEAUE_DUMP
	..0. If CEEAUE_ABND=0, ABEND with no dump
	..1. If CEEAUE_ABND=1, ABEND with a dump
	...x CEEAUE_STEPS
	...0 ABEND the task
	...1 ABEND the step
 0000 Reserved (must be zero)
Byte 1	0000 0000 Reserved for future use
Byte 2	0000 0000 Reserved for future use
Byte 3	0000 0000 Reserved for future use

Figure 4. CEEAUE_FLAGS Format

Byte 0 (CEEAUE_FLAG1) has the following meaning:

CEEAUE_ABTERM (input parameter)

- OFF** Indicates that the enclave is terminating normally (severity 0 or 1 condition).
- ON** Indicates that the enclave is terminating with an Language Environment return code modifier of 2 or greater. This could, for example, indicate that a severity 2 or greater condition was raised but not handled.

CEEAUE_ABND (input/output parameter)

- OFF** Indicates that the enclave should terminate without an abend being issued. Thus, CEEAUE_RETC and CEEAUE_RSNC are placed into register 15 and register 0 and returned to the enclave creator.
- ON** Indicates that the enclave terminates with an abend. Thus, CEEAUE_RETC and CEEAUE_RSNC are used by Language

Environment in the invocation of the abend. During running in CICS, an EXEC CICS ABEND command is issued.

The TRAP run-time option does not affect the setting of CEEAUE_ABND.

When the ABTERMENC(ABEND) run-time option is specified, the enclave always terminates with an abend when there is an unhandled condition of severity 2 or greater, regardless of the setting of the CEEAUE_ABND flag. For a detailed explanation of how the CEEAUE_ABND parameter can affect the behavior of the ABTERMENC run-time option, see *z/OS: Language Environment Programming Guide*.

CEEAUE_DUMP (output parameter)

OFF Indicates that when you request an abend, an abend is issued without requesting a dump.

ON Indicates that when you request an abend, an abend requesting a dump is issued.

z/VM currently honors the dump request on an abend if you specify the destination in one of the following FILEDEF statements:

- FILEDEF SYSABEND PRINTER
- FILEDEF SYSUDUMP PRINTER

CEEAUE_STEPS (output parameter)

OFF Indicates that when you request an abend, an abend is issued to abend the entire TASK.

ON This parameter is ignored under z/VM.

CEEAUE_A_CC_PLIST (input/output parameter)

A fullword pointer to the parameter address list of the application program.

If the parameter is not a character string, CEEAUE_A_CC_PLIST contains the register 1 value as passed by the calling program or operating system at the time of program entry.

If the parameter inbound to the MAIN routine is a character string, CEEAUE_A_CC_PLIST contains the address of a fullword address that points to a halfword prefixed string. If this string is altered by the user exit, the string must not be extended in place.

CEEAUE_WORK (input parameter)

A fullword pointer to a 256-byte work area that the exit can use. On entry it contains binary zeros and is doubleword-aligned.

This area does not persist across exits.

CEEAUE_A_OPTIONS (output parameter)

Upon return, this field contains a fullword pointer to the address of a halfword-length prefixed character string that contains run-time options. These options are honored only during the initialization of an enclave. When invoked for enclave termination, this field is ignored.

These run-time options override all other sources of run-time options except those that are specified as NONOVR in the installation default run-time options.

The LIBRARY and VERSION run-time options cannot be specified in the CEEAUE_A_OPTIONS output string. When the assembler user exit is invoked, it is too late to change any of these options.

CEEAUE_USERWD (input/output parameter)

A fullword whose value is maintained without alteration and passed to every

Run-Time User Exits

user exit. Upon entry to the enclave initialization user exit, it is zero. Thereafter, the value of the user word is not altered by Language Environment or any member libraries. The user exit might change the value of this field, and Language Environment maintains that value. This allows the user exit to acquire a work area, initialize it, and pass it to subsequent user exits. The work area might be freed by the termination user exit.

CEEAEU_A_AB_CODES (output parameter)

During the initialization exit, this field contains a fullword address of a table of abend codes that the Language Environment condition handler percolates while in the (E)STAE exit. Therefore, the application does not have the chance to address the abend. This table is honored prior to shunt routines. The table consists of:

- A fullword count of the number of abend codes that are to be percolated
- A fullword for each of the particular abend codes that are to be percolated

The abend codes might be either user abend codes or system abend codes. User abend codes are specified by F'uuu'. For example, if you want to percolate user ABEND 777, a F'777' would be coded. System abend codes are specified by X'00sss000'.

CEEAEU_FBCODE (input parameter)

Contains a fullword address of the condition token with which the enclave terminated. If the enclave terminates normally (that is, not due to a condition), the condition token is zero.

CEEAEU_PAGE (input parameter)

This parameter indicates whether PL/I BASED variables that are allocated storage outside of AREAs are allocated on a 4K-page boundary. You can specify in the field the minimum number of bytes of storage that must be allocated. Your allocation request must be an exact multiple of 4K.

The IBM-supplied default setting for CEEAEU_PAGE is 32768 (32K).

If CEEAEU_PAGE is set to zero, PL/I BASED variables can be placed on other than 4K-page boundaries.

CEEAEU_PAGE is honored only during enclave initialization, that is, when CEEAEU_FUNC is 1 or 3.

The offset of CEEAEU_PAGE under Language Environment is different than under OS PL/I Version 2 Release 3.

Chapter 7. Using Preinitialization Services

You can use preinitialization to enhance the performance of your application. Preinitialization lets an application initialize an HLL environment once, perform multiple executions using that environment, and then explicitly terminate the environment. Because the environment is initialized only once (even if you perform multiple executions), you free up system resources and allow for faster responses to your requests.

This chapter describes z/VM specific considerations for Language Environment preinitialization service routines. For more information on preinitialization, see *z/OS: Language Environment Programming Guide*.

Restriction: XPLINK programs are not supported in the PreInit environment.

Service Routines

Under Language Environment, you can specify several service routines to execute a main routine or subroutine in the preinitialized environment. To use the routines, specify a list of addresses of the routines in a service routine vector as shown in Figure 5.

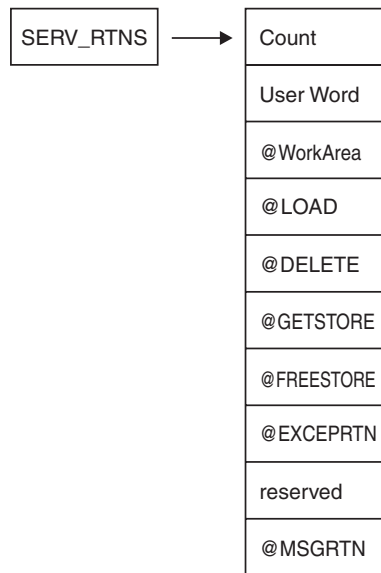

Figure 5. Format of Service Routine Vector

The service routine vector is composed of a list of fullword addresses of routines that are used instead of Language Environment service routines. The list of addresses is preceded by the number of the addresses in the list, as specified in the *count* field of the vector. The *service_rtns* parameter that you specify in calls to CEEPIPI(*init_main*) and CEEPIPI(*init_sub*) contains the address of the vector itself. If this pointer is specified as zero (0), Language Environment routines are used instead of the service routines shown in Figure 5.

The @GETSTORE and @FREESTORE service routines must be specified together; if one is zero, the other is automatically ignored. The same is true for the

Preinitialization Services

@LOAD and @DELETE service routines. If you specify the @GETSTORE and @FREESTORE service routines, you must also specify the @LOAD and @DELETE service routines.

The service routines may be AMODE(31) / RMODE(ANY) if the application has no AMODE(24) programs. Otherwise the service routines must be AMODE(ANY) / RMODE(24).

Count

A fullword binary number representing the number of fullwords that follow. The *count* does not include itself. In Figure 5 on page 49, the count is 9. For each vector slot, a zero represents the absence of the routine, a nonzero represents the presence of a routine.

User Word

A fullword that is passed to the service routines. The *user word* is provided as a means for your routine to communicate to the service routines.

@WorkArea

An address of a work area of at least 256 bytes that is doubleword aligned. The first word of the area contains the length of the area provided. This parameter is required if service routines are present in the service routine vector.

@LOAD

This routine loads named routines for application management. Under VM, this routine can load modules from nucleus extension, saved segment, or relocatable load library members. The search sequence is in the same order. The parameter that is passed contains the following:

- Name_addr** The fullword address of the name of the module to load (input parameter).
- Name_length** A fixed binary(31) length of the module name (input parameter).
- User_word** A fullword user field (input parameter).
- Load_point** Either zero (0), or the address where the @LOAD routine is to store the load point address of the loaded routine (input and output parameter).
- Entry_point** The fullword entry point address of the loaded routine (output parameter).
- Module_size** The fixed binary(31) size of the module that was loaded (output parameter).
- Return code** The fullword return code from load (output).
- Reason code** The fullword reason code from load (output).

The return and reason codes are listed in Table 13.

Table 13. Return and Reason Codes

Return Code	Reason Code	Description
0	0	Successful
0	4	Successful — found as a CMS nucleus extension
0	8	Successful — loaded as a CMS shared segment
0	12	Successful — loaded using SVC8
4	4	Unsuccessful — module loaded above the line when in AMODE(24)

Table 13. Return and Reason Codes (continued)

Return Code	Reason Code	Description
8	4	Unsuccessful — load failed
16	4	Unsuccessful — uncorrectable error occurred

@DELETE

This routine deletes routines for application management. Under VM, this routine can load modules from nucleus extension, saved segment, or relocatable load modules. The search sequence is in the same order. The parameter that is passed contains the following:

Name_addr

The fullword address of the module name to be deleted (input parameter).

Name_length

A fixed binary(31) length of module name (input parameter).

User_word

A fullword user field (input parameter).

Rsvd_word

A fullword reserved for future use (input parameter); must be zero.

Return code

The return code from delete service (output).

Reason code

The reason code from delete service (output).

The return and reason codes are listed in Table 14.

Table 14. Return and Reason Codes

Return Code	Reason Code	Description
0	0	Successful
8	4	Unsuccessful — delete failed
16	4	Unsuccessful — uncorrectable error occurred

@GETSTORE

This routine allocates storage on behalf of the storage manager. This routine can rely on the caller to provide a save area, which can be the @Workarea. The parameter list that is passed contains the following:

Amount

A fixed binary(31) amount of storage requested (input parameter).

Subpool_no

A fixed binary(31) subpool number 0-127 (input parameter). Language Environment allocates storage from the process-level storage pools.

User word

A fullword user field (input parameter).

Flags A fullword flag area (input parameter).

Preinitialization Services

Bit zero in Flags is ON if the storage is required below the 16M line. The remaining bits are reserved for future use and must be zero. Bit zero in Flags is OFF if the storage required can be allocated anywhere.

Stg_address

The fullword address of the storage obtained or zero (output parameter).

Obtained

A fixed binary(31) number of bytes obtained (output parameter).

Return code

The return code from @GETSTORE service (output parameter).

Reason code

The reason code from the @GETSTORE service (output parameter).

The return and reason codes are listed in Table 15.

Table 15. Return and Reason Codes

Return Code	Reason Code	Description
0	0	Successful
16	0	Unsuccessful — uncorrectable error occurred

@FREESTORE

This routine frees storage on behalf of the storage manager. The parameter list passed contains the following:

Amount

The fixed binary(31) amount of storage to free (input parameter).

Subpool_no

The fixed binary(31) subpool number 0-127 (input parameter).
Language Environment allocates storage from the process-level storage pools.

User word

A fullword user field (input parameter).

Stg_address

The fullword address of the storage to free (input parameter).

Return code

The return code from the @FREESTORE service (output).

Reason code

The reason code from the @FREESTORE service (output).

The return and reason codes are listed in Table 16.

Table 16. Return and Reason Codes

Return Code	Reason Code	Description
0	0	Successful
16	0	Unsuccessful — uncorrectable error occurred

@EXCEPRTN

This routine traps program interruptions and abends for condition management. The parameter list passed contains the following:

Handler_addr

During an initialization call, this parameter contains the address of the CEL condition handler. During a termination call, this parameter contains a pointer to a fullword field containing zeroes.

Environment_token

A fullword Recovery Environment token (input). (Note that this token is different from the PIP1 environment token used with CEEPIPI calls.)

User_word

A fullword user field (input parameter)

Abend_flags

A fullword flag area containing abend flags (input)

Check_flags

A fullword flag area containing program check flags (input)

Return code

The return code from the @EXCEPRTN service (output).

Reason code

The reason code from the @EXCEPRTN service (output).

The exception router is responsible for trapping and routing exceptions. These are the services typically obtained via the ESTAE and ESPIE macros.

During initialization, if the TRAP option is in effect the common library puts the address of the Language Environment exception in the first field of the above parameter list, and sets the environment token field to a value that will be passed on to the exception handler. It also sets abend and check flags as appropriate, and then calls your exception router to establish an exception handler.

The meaning of the bits in the abend flags are given by the following declare:

```

dc1
  1 abendflags,
    2 system,
      3 abends bit(1), /* control for system abends desired */
      3 rsrv1 bit(15), /* reserved */
    2 user,
      3 abends bit(1), /* control for user abends desired */
      3 rsrv2 bit(15); /* reserved */

```

The meaning of the bits in the check flags is given by the following declare:

```

1 checkflags,
  2 type,
    3 reserved3 bit(1),
    3 operation bit(1),
    3 privileged_operation bit(1),
    3 execute bit(1),
    3 protection bit(1),
    3 addressing bit(1),
    3 specification bit(1),
    3 data bit(1),
    3 fixed_overflow bit(1),
    3 fixed_divide bit(1),
    3 decimal_overflow bit(1),
    3 decimal_divide bit(1),
    3 exponent_overflow bit(1),
    3 exponent_underflow bit(1),
    3 significance bit(1),
    3 float_divide bit(1),
  2 reserved4 bit(16);

```

Preinitialization Services

The return and reason codes that the exception router must use are listed in Table 17.

Table 17. Return and Reason Codes

Return Code	Reason Code	Description
0	0	Successful
4	4	Unsuccessful — the exit could not be established or removed
16	4	Unsuccessful — unrecoverable error occurred

When an exception occurs, the exception router must determine if the established exception handler is interested in the exception (by examining abend and check flags). If the exception handler is not interested in the exception, the exception router must treat the program as in error, but can assume the environment for the thread to be functional and reusable. If the exception handler is interested in the exception, the exception router must invoke the exception handler, passing the parameters listed in Table 18.

Table 18. Parameters for EXCEPRTN

Parameter	Attributes	Type
Environment Token	Pointer	Input
SDWA	Pointer	Input
Return Code	Fixed Bin(31)	Output
Reason Code	Fixed Bin(31)	Output

The return and reason codes upon return from the exception handler are listed in Table 19.

Table 19. Return and Reason Codes

Return Code	Reason Code	Description
0	0	Continue with the exception. Percolate the exception taking whatever action would have been taken had it not been handled at all. In this case, your exception router can assume the environment for the thread to be functional and reusable.
0	4	Continue with the exception. Percolate the exception taking whatever action would have been taken had it not been handled at all. In this case, the environment for the thread is probably unreliable and not reusable. A forced termination is suggested.
4	0	Resume execution using the updated SDWA. The invoked exception handler will have already used the SETRP RTM macro to set the SDWA for correct resumption.

During termination, the exception router is invoked with the exception handler address (first parameter) set to zero to de-establish the exit (if it was established during initialization).

When a nested enclave is created, the Language Environment exception handler calls the exception router to establish another exception handler exit,

and then makes a call to de-establish it when the nested enclave terminates. If an exception occurs while the second exit is active, special processing is performed. Depending on what this second exception is, either the first exception will not be retried, or processing will continue on the first exception by requesting retry for the second exception.

If the Language Environment exception handler determines that execution should resume for an exception, it will set the SDWA with SETRP and return with return/reason codes 4/0. Execution will resume in library code or in user code, depending on what the exception was.

The exception router must be capable of restoring all the registers from the SDWA when control is given to the retry routine. The ESPIE and ESTAE services are capable of accomplishing this.

In using the exception router service:

- The exception router should not invoke the Language Environment exception handler if active I/O has been halted and is not restorable.
- This service requires an XA or ESA environment.
- This service is not supported under CMS.

If an exception occurs while the exception handler is in control before another exception handler exit has been stacked, the exception router should assume that the exception could not be handled and that the environment for the program (thread) is damaged. In this case, the exception router should force termination of the preinitialized environment.

@MSGRTN

This routine allows error messages to be processed by the caller of the application.

If the message pointer is zero, your message routine is expected to return the size of the line to which messages are written (in the `line_length` field). This allows messages to be formatted correctly — that is, broken at places such as blanks.

Message

A pointer to the first byte of text that is printed, or zero (input parameter).

Msg_len

The fixed binary(31) length of the message (input parameter).

User word

A fullword user field (input parameter).

Line_length

The fixed binary(31) size of the output line length. This is used when Message is zero (output parameter).

Return and reason codes

Two fullwords containing the return and reason codes listed in Table 20 (output parameters).

Table 20. Return and Reason Codes

Return Code	Reason	
	Code	Description
0	0	Successful
16	4	Unsuccessful — uncorrectable error occurred

An Example Program Invocation of CEEPIPI

In the example shown in Figure 6 on page 57, assembler program ASMPIPI ASSEMBLE invokes CEEPIPI to:

- Initialize a subroutine environment under Language Environment
- Load and call a reentrant HLL subroutine
- Terminate the Language Environment environment

For examples of the program HLLPIPI written in C, COBOL, and PL/I, see *z/OS Language Environment Programming Guide*.

When using HLLPIPI C under z/VM, enter these commands:

```
LOAD HLLPIPI (RLDSAVE RESET HLLPIPI  
GENMOD HLLPIPI
```



```

*COMPILATION UNIT: LEASMPIP
*****
*
*   Function : CEEPIPI - Initialize the PIPI environment,
*                   call a PIPI HLL program, and terminate
*                   the environment.
*
* 1.Call CEEPIPI to initialize a subroutine environment under LE.
* 2.Call CEEPIPI to load and call a reentrant HLL subroutine.
* 3.Call CEEPIPI to terminate the LE PIPI environment.
*
* Note: ASMPIPI is not reentrant.
*
*****
* =====
* Standard program entry conventions.
* =====
ASMPIPI CSECT
      STM  R14,R12,12(R13)   Save caller's registers
      LR   R12,R15           Get base address
      USING ASMPIPI,R12     Identify base register
      ST   R13,SAVE+4       Back-chain the save area
      LA   R15,SAVE         Get addr of this routine's save area
      ST   R15,8(R13)       Forward-chain in caller's save area
      LR   R13,R15          R13 -> save area of this routine
*
* Load LE CEEPIPI service routine into main storage.
*
      COMPSWT ON             Set flag to load MODULEs
      LOAD  EP=CEEPIPI      Load CEEPIPI routine dynamically
      COMPSWT OFF          Reset flag to load MODULEs
      ST   R0,PPRTNPTR      Save the addr of CEEPIPI routine
*
* Initialize an LE PIPI subroutine environment.
*
INIT_ENV EQU *
      LA   R5,PPTBL         Get address of PIPI Table
      ST   R5,@CEXPTBL     Ceexptbl-addr -> PIPI Table
      L    R15,PPRTNPTR    Get address of CEEPIPI routine
*
      CALL (15),(INITSUB,@CEXPTBL,@SRVRTNS,RUNTMOPT,TOKEN)
      Invoke CEEPIPI routine
*
      LTR  R2,R15           Check return code:
                          Is R15 = zero?
      BZ   CSUB             Yes (success).. go to next section
*
                          No (failure).. issue message

```

Figure 6. Assembler Driver That Creates a Preinitialized Environment (Part 1 of 3)

Preinitialization Services

```

        WTO 'ASMPIPI : call to CEEPIPI(INIT_SUB) failed',ROUTCDE=11
        C   R2,=F'8'           Check for partial initialization
        BE   TSUB              Yes.. go do PIPI termination
*                               No.. issue message & quit
        WTO 'ASMPIPI : INIT_SUB failure RC is not 8.',ROUTCDE=11
        ABEND (R2),DUMP        Abend with bad RC and dump memory
*
* Call the subroutine, which is loaded by LE
*
CSUB   EQU   *
        L   R15,PPRTNPTR      Get address of CEEPIPI routine
        CALL (15),(CALLSUB,PTBINDEXTOKEN,PARMPTR,           X
        SUBRETC,SUBRSNC,SUBFBC)  Invoke CEEPIPI routine
*                               Check return code:
        LTR  R2,R15           Is R15 = zero?
        BZ   TSUB              Yes (success).. go to next section
*                               No (failure).. issue message & quit
        WTO 'ASMPIPI : call to CEEPIPI(CALL_SUB) failed',ROUTCDE=11
        ABEND (R2),DUMP        Abend with bad RC and dump memory
*
* Terminate the environment
*
TSUB   EQU   *
        L   R15,PPRTNPTR      Get address of CEEPIPI routine
        CALL (15),(TERM,TOKEN,ENV_RC) Invoke CEEPIPI routine
*                               Check return code:
        LTR  R2,R15           Is R15 = zero ?
        BZ   DONE              Yes (success).. go to next section
*                               No (failure).. issue message & quit
        WTO 'ASMPIPI : call to CEEPIPI(TERM) failed',ROUTCDE=11
        ABEND (R2),DUMP        Abend with bad RC and dump memory
*
* Standard exit code.
*
DONE   EQU   *
        LA  R15,0              Passed return code for system
        L   R13,SAVE+4         Get address of caller's save area
        L   R14,12(R13)        Reload caller's register 14
        LM  R0,R12,20(R13)     Reload caller's registers 0-12
        BR  R14                Branch back to caller
*
* =====
* CONSTANTS and SAVE AREA.
* =====
SAVE   DC   18F'0'
PPRTNPTR DS  A                Save the address of CEEPIPI routine
*
* Parameters passed to a CEEPIPI(INIT_SUB) call.
*
INITSUB DC  F'3'              Function code to initialize for subr
@CEXPTBL DC A(PPTBL)         Address of PIPI Table
@SRVRTNS DC A(0)             Addr of service-rtns vector, 0 = none
RUNTMOPT DC CL255' '        Fixed length string of runtime optns
TOKEN   DS   F                Unique value returned (output)
*
* Parameters passed to a CEEPIPI(CALL_SUB) call.
*
CALLSUB DC  F'4'              Function code to call subroutine
PTBINDEXT DC F'0'            The row number of PIPI Table entry
PARMPTR DC  A(0)             Pointer to @PARMLIST or zero if none
SUBRETC DS  F                Subroutine return code (output)
SUBRSNC  DS  F                Subroutine reason code (output)
SUBFBC   DS  3F              Subroutine feedback token (output)
*

```

Figure 6. Assembler Driver That Creates a Preinitialized Environment (Part 2 of 3)

```

* Parameters passed to a CEEPIPI(TERM) call.
*
TERM      DC      F'5'          Function code to terminate
ENV_RC    DS      F            Environment return code (output)
*
* =====
* PIPi Table.
* =====
PPTBL     CEEXPIT ,           PIPi Table with index
          CEEXPITY HLLPIPI,0  0 = dynamically loaded routine
*
          CEEXPITS ,         End of PIPi table
*
*
          LTORG
R0        EQU      0
R1        EQU      1
R2        EQU      2
R3        EQU      3
R4        EQU      4
R5        EQU      5
R6        EQU      6
R7        EQU      7
R8        EQU      8
R9        EQU      9
R10       EQU     10
R11       EQU     11
R12       EQU     12
R13       EQU     13
R14       EQU     14
R15       EQU     15
          END      ASMPIPI

```

Figure 6. Assembler Driver That Creates a Preinitialized Environment (Part 3 of 3)

Chapter 8. Using Nested Enclaves

An enclave is a logical run-time structure that supports the execution of a collection of routines (for a detailed description of Language Environment enclaves, see *z/OS: Language Environment Programming Guide*).

Language Environment explicitly supports the execution of a single enclave within a Language Environment process. However, by using the system services and language constructs described in this chapter, you can create an additional, or nested, enclave and initiate its execution within the same process.

The enclave that issues a call to system services or language constructs to create a nested enclave is called the *parent* enclave. The nested enclave that is created is called the *child* enclave. The child must be a main routine; a link to a subroutine by commands and language constructs is not supported under Language Environment.

If a process contains nested enclaves, none or only one enclave can be running with POSIX(ON).

Understanding the Basics

In Language Environment, you can use the following methods to create a child enclave:

- the SVC LINK or CMSCALL commands (for more information about SVC LINK and CMSCALL, see your system reference)
- the C `system()` function (for more information about `system()`, see *z/OS XL C/C++ Programming Guide*)
- the PL/I FETCH and CALL to any of the following PL/I routines with PROC OPTIONS(MAIN) specified:
 - PL/I for MVS & VM
 - OS PL/I Version 2
 - OS PL/I Version 1 Release 5.1
 - Relinked OS PL/I Version 1 Release 3.0 – 5.1

Such a routine, called a *fetchable main* in this book, can only be introduced by a FETCH and CALL from a PL/I routine. COBOL cannot dynamically call a PL/I main and C cannot issue a `fetch()` against a PL/I main. In addition, a fetchable main cannot be dynamically loaded using the CEELoad macro.

The routine performing the FETCH and CALL must be compiled with the PL/I for MVS & VM compiler, or be a relinked OS PL/I routine.

If the target routine of any of these commands is not written in a Language Environment-conforming HLL or Language Environment-conforming assembler, no nested enclave is created.

XPLINK Considerations

A nested enclave situation where the parent enclave is running in an XPLINK(OFF) environment and the child enclave requires XPLINK(ON) is not supported. A parent enclave running XPLINK(ON) will support a nested child enclave of either XPLINK(ON) or XPLINK(OFF). In the latter case, the application in the child enclave will go through compatibility glue code when calling the C RTL (that is, the child enclave will run with an environment with the XPLINK run-time option forced ON).

COBOL Considerations

OS/VS COBOL programs are supported in a single enclave only.

Determining the Behavior of Child Enclaves

If you want to create a child enclave, you need to consider the following factors:

- The language of the main routine in the child enclave
- The sources from which each type of child enclave gets run-time options
- The default condition handling behavior of each type of child enclave
- The setting of the TRAP run-time option in the parent and the child enclave

All of these interrelated factors affect the behavior, particularly the condition handling, of the created enclave. The sections that follow describe how the child enclaves created by each method (SVC LINK, CMSCALL, C system() function, and PL/I FETCH and CALL of a fetchable main) will behave.

Creating Child Enclaves by Calling a Second Main Program

The behavior of a child enclave created by calling a second main program is determined by the language of its main or initializing routine: C, C++, COBOL, PL/I, or Language Environment-conforming assembler (generated by use of the CEEENTRY and associated macros).

How Run-Time Options Affect Child Enclaves

Run-time options will be processed in the normal manner for enclaves created because of a call to a second main, that is, programmer defaults present in the load module will be merged, options in the command line equivalent will also be processed, as will options passed by the assembler user exit if present.

How Conditions Arising in Child Enclaves Are Handled

The command-line equivalent is determined in the same manner as for a SVC LINK.

Creating Child Enclaves Using SVC LINK or CMSCALL

The behavior of a child enclave created by an SVC LINK or CMSCALL is determined by the language of its main routine: C, C++, COBOL, PL/I, or Language Environment-conforming assembler (generated by use of the CEEENTRY and associated macros).

If you want to issue a LINK to a routine, you must first either use the LKED command to put the target routine's object module into a LOADLIB or use the LOAD command with the RLDSAVE option and the GENMOD command with the NOMAP option to create a relocatable load module. For more information about the LKED command, see "Link-Editing with the LKED Command" on page 14.

If you want to issue a CMSCALL to a routine, you must first use either the LOAD and GENMOD commands or the BIND command to put the target routine's object code into a CMS MODULE. For more information about these commands see "Using the LOAD and INCLUDE Commands" on page 9, "Using the GENMOD Command" on page 12, and "Using the BIND Command" on page 13.

How Run-Time Options Affect Child Enclaves

Child enclaves created by an SVC LINK or CMSCALL get run-time options differently, depending on the language that the main routine of the child enclave is written in.

Child Enclave Has a C, C++, PL/I, or Language Environment-Conforming

Assembler Main Routine: If the main routine of the child enclave is written in C, C++, PL/I, or in Language Environment-conforming assembler, the child enclave gets its run-time options through a merge from the usual sources (see *z/OS: Language Environment Programming Guide* for more information). Therefore, you can set run-time options on an enclave-by-enclave basis.

Child Enclave Has a COBOL Main Program: If the main program of the child enclave is written in COBOL, the child enclave inherits the run-time options of the creating enclave. Therefore, you cannot set run-time options on an enclave-by-enclave basis.

How Conditions Arising in Child Enclaves Are Handled

If a Language Environment or CEEBXITA-initiated (generated by setting the CEEAUE_ABND field of CEEBXITA) abend occurs in a child enclave created by SVC LINK or CMSCALL, regardless of the language of its main, the entire process is terminated.

Condition handling in child enclaves created by SVC LINK or CMSCALL varies, depending on the language of the child's main routine, the setting of the TRAP run-time option in the parent and child enclaves, and the type of condition. Refer to one of the following tables to see what happens when a condition remains unhandled in a child enclave.

Table 21. Handling Conditions in Child Enclaves

If the Child Enclave Was Created By:	See:
An SVC LINK or CMSCALL under CMS and has a C or Language Environment-conforming assembler main routine	Table 22
An SVC LINK or CMSCALL under CMS and has a COBOL main program	Table 23 on page 64
An SVC LINK or CMSCALL under CMS and has a PL/I main routine	Table 24 on page 65

You should always run your applications with TRAP(ON) or your results might be unpredictable.

Child Enclave Has a C, C++, or Language Environment-Conforming Assembler

Main Routine: Table 22 shows the unhandled condition behavior under CMS.

Table 22. Unhandled Condition Behavior in a C or Assembler Child Enclave, under CMS

Condition	Parent Enclave TRAP(ON)	Parent Enclave TRAP(ON)	Parent Enclave TRAP(OFF)	Parent Enclave TRAP(OFF)
	Child Enclave TRAP(ON)	Child Enclave TRAP(OFF)	Child Enclave TRAP(ON)	Child Enclave TRAP(OFF)
Unhandled condition severity 0 or 1	Resume child enclave	Resume child enclave	Resume child enclave	Resume child enclave
Unhandled condition severity 2 or above	Resume parent enclave, and ignore condition	Resume parent enclave, and ignore condition	Resume parent enclave, and ignore condition	Resume parent enclave, and ignore condition

Using Nested Enclaves

Table 22. Unhandled Condition Behavior in a C or Assembler Child Enclave, under CMS (continued)

Condition	Parent Enclave TRAP(ON)	Parent Enclave TRAP(ON)	Parent Enclave TRAP(OFF)	Parent Enclave TRAP(OFF)
	Child Enclave TRAP(ON)	Child Enclave TRAP(OFF)	Child Enclave TRAP(ON)	Child Enclave TRAP(OFF)
Non-Language Environment abend	Process terminated with original abend code	Process terminated with original abend code	Process terminated with original abend code	Process terminated with original abend code
Program check	Resume parent enclave, and ignore condition	Process terminated with abend U4036, Reason Code=2	Resume parent enclave, and ignore condition	Process terminated with CMS message

Child Enclave Has a COBOL Main Program: Child enclaves created by SVC LINK or CMSCALL that have a COBOL main program inherit the run-time options of the parent enclave that created them. Therefore, the TRAP setting of the parent and child enclaves is always the same.

Table 23 shows unhandled condition behavior under z/VM.

Table 23. Unhandled Condition Behavior in a COBOL Child Enclave, under z/VM

Condition	Parent Enclave TRAP(ON)	Parent Enclave TRAP(OFF)
	Child Enclave TRAP(ON)	Child Enclave TRAP(OFF)
Unhandled condition severity 0 or 1	Resume child enclave	Resume child enclave
Unhandled condition severity 2 or above	Process terminated with abend U4094 RC=40	Process terminated with abend U4094 RC=40
Non-Language Environment abend	Process terminated with original abend code	Process terminated with original abend code
Program check	Process terminated with abend U4094 RC=40	Process terminated with CMS message

Child Enclave Has a PL/I Main Routine: Table 24 on page 65 lists unhandled condition behavior under z/VM.

Table 24. Unhandled Condition Behavior in a PL/I Child Enclave, under z/VM

Condition	Parent Enclave TRAP(ON)	Parent Enclave TRAP(ON)	Parent Enclave TRAP(OFF)	Parent Enclave TRAP(OFF)
	Child Enclave TRAP(ON)	Child Enclave TRAP(OFF)	Child Enclave TRAP(ON)	Child Enclave TRAP(OFF)
Unhandled condition severity 0 or 1	Resume child enclave	Resume child enclave	Resume child enclave	Resume child enclave
Unhandled condition severity 2 or above	Process terminated with abend U4094 RC=40	Process terminated with abend U4094 RC=40	Process terminated with abend U4094 RC=40	Process terminated with abend U4094 RC=40
Non-Language Environment abend	Process terminated with original abend code	Process terminated with original abend code	Process terminated with original abend code	Process terminated with original abend code
Program check	Process terminated with abend U4094 RC=40	Process terminated with abend U4036 RC=2	Process terminated with abend U4094 RC=40	Process terminated with CMS message

Creating Child Enclaves Using the C system() Function

Child enclaves created by the C `system()` function get run-time options through a merge from the usual sources (for more information, see *z/OS: Language Environment Programming Guide*). Therefore, you can set run-time options on an enclave-by-enclave basis. For information on the `system()` function when running with POSIX(ON), see *XL C/C++ for z/VM: Runtime Library Reference*.

Run-time options specified in the PARM= portion of the `system()` function are ignored when you perform a `system()` function to a COBOL program in the following form:

```
system("PGM=program_name,PARM='... '")
```

However, run-time options are merged from CEEDOPT, CEEUOPT, and the CEEAUE_A_OPTIONS from the assembler user exit.

OpenExtensions Considerations

To create a nested enclave under Open Extensions, you must either:

- Be running with POSIX(OFF) and issue `system()`, or
- Be running with POSIX(ON) and have set the environment variables to signal that you want to establish a nested enclave. You can use the `__POSIX_SYSTEM` environment variable to cause a `system()` to establish a nested enclave instead of performing a `spawn()`. `__POSIX_SYSTEM` can be set to NO, No, or no.

The `system()` function is not thread safe. It cannot be called simultaneously from more than one thread. A multi-threaded application must ensure that no more than one `system()` call is ever outstanding from the various threads. If this restriction is violated, unpredictable results may occur. In a multiple enclave environment, the first enclave must be running with POSIX(ON) and all other nested enclaves must be running with POSIX(OFF).

Using Nested Enclaves

How Conditions Arising in Child Enclaves Are Handled

If a Language Environment- or CEEBXITA-initiated (generated by setting the CEEAUE_ABND field of CEEBXITA) abend occurs in a child enclave created by a call to `system()`, the entire process is terminated.

Depending on what the settings of the TRAP run-time option are in the parent and child enclave, the following might cause the child enclave to terminate:

- Unhandled user abend
- Unhandled program check

TRAP(ON | OFF) Effects for Enclaves Created by `system()`

Table 25 describes the effects of TRAP(ON|OFF) for enclaves that are created by the `system()` function on a z/VM system.

Table 25. Unhandled Condition Behavior in a `system()`-Created Child Enclave, under z/VM

Condition	Parent Enclave TRAP(ON)	Parent Enclave TRAP(ON)	Parent Enclave TRAP(OFF)	Parent Enclave TRAP(OFF)
	Child Enclave TRAP(ON)	Child Enclave TRAP(OFF)	Child Enclave TRAP(ON)	Child Enclave TRAP(OFF)
Unhandled condition severity 0 or 1	Resume child enclave	Resume child enclave	Resume child enclave	Resume child enclave
Unhandled condition severity 2 or above	Resume parent enclave, and ignore condition	Resume parent enclave, and ignore condition	Resume parent enclave, and ignore condition	Resume parent enclave, and ignore condition
Non-Language Environment abend	Process terminated with original abend code	Process terminated with original abend code	Process terminated with original abend code	Process terminated with original abend code
Program check	Resume parent enclave, and ignore condition	Process terminated with abend U4036, Reason Code=2	Resume parent enclave, and ignore condition	Process terminated with CMS message

Creating Child Enclaves Containing a PL/I Fetchable Main

Under z/VM, the target load module can only be a member of a LOADLIB or be in a saved segment or relocatable load module. The target load module cannot be on a text deck or be a member of a TXTLIB.

Additional fetch and call considerations of PL/I fetchable mains are discussed in “Special Fetch and Call Considerations” on page 67.

How Run-Time Options Affect Child Enclaves

Child enclaves created when you issue a FETCH and CALL of a fetchable main get run-time options through a merge from the usual sources (see *z/OS: Language Environment Programming Guide* for more information). Therefore, you can set run-time options on an enclave-by-enclave basis.

How Conditions Arising in Child Enclaves Are Handled

If a Language Environment or CEEBXITA-initiated (generated by setting the CEEAUE_ABND field of CEEBXITA) abend occurs in a child enclave that contains a fetchable main, the entire process is terminated.

Depending on what the settings of the TRAP run-time option are in the parent and child enclave, the following might cause the child enclave to terminate:

- Unhandled user abend
- Unhandled program check

Table 26 describes the unhandled condition behavior in a child enclave that is created under z/VM.

Table 26. Unhandled Condition Behavior in a Child Enclave That Contains a Fetchable Main, under z/VM

Condition	Parent Enclave TRAP(ON)	Parent Enclave TRAP(ON)	Parent Enclave TRAP(OFF)	Parent Enclave TRAP(OFF)
	Child Enclave TRAP(ON)	Child Enclave TRAP(OFF)	Child Enclave TRAP(ON)	Child Enclave TRAP(OFF)
Unhandled condition severity 0 or 1	Resume child enclave	Resume child enclave	Resume child enclave	Resume child enclave
Unhandled condition severity 2 or above	Resume parent enclave, and ignore condition	Resume parent enclave, and ignore condition	Resume parent enclave, and ignore condition	Resume parent enclave, and ignore condition
Non-Language Environment abend	Process terminated with original abend code	Process terminated with original abend code	Process terminated with original abend code	Process terminated with original abend code
Program check	Resume parent enclave, and ignore condition	Process terminated with U4036 RC=2	Resume parent enclave, and ignore condition	Process terminated with CMS message

Special Fetch and Call Considerations

You should not recursively fetch and call the fetchable main from within the child enclave; results are unpredictable if you do.

The load module that is the target of the FETCH and CALL is reentrant if all routines in the load module are reentrant. (See *z/OS: Language Environment Programming Guide* for more information on reentrancy.)

Language Environment relies on the underlying operating system for the management of load module attributes. In general, multiple calls of the same load module are supported for load modules that are any of the following:

- Reentrant
It is recommended that your target load module be reentrant.
- Nonreentrant but serially reusable
You should ensure that the main procedure of a nonreentrant but serially reusable load module is self-initializing. Results are unpredictable otherwise.

Using Nested Enclaves

- Nonreentrant and non-serially reusable
If a nonreentrant and non-serially reusable load module is called multiple times, each new call brings in a fresh copy of the load module. That is, there are two copies of the load module in storage: one from FETCH and one from CALL. Even though there are two copies of the load module in storage, you need only one PL/I RELEASE statement because upon return from the created enclave the load module loaded by CALL is deleted by the operating system. You need only release the load module loaded by FETCH.

Other Nested Enclave Considerations

The following sections contain other information you might need to know when creating nested enclaves. The topics include:

- The string that CEE3PRM returns for each type of child enclave (for more information about the CEE3PRM callable service, see *z/OS: Language Environment Programming Reference*)
- The return and reason codes that are returned on termination of the child enclave
- How the assembler user exit handles nested enclaves
- Whether the message file is closed on return from a child enclave
- z/OS UNIX[®] considerations
- AMODE considerations

What the Enclave Returns from CEE3PRM

CEE3PRM returns to the calling routine the user parameter string that was specified at program invocation. Only program arguments are returned.

See Table 27 to determine whether a user parameter string was passed to your routine, and where the user parameter string is found. This depends on the method you used to create the child enclave, the language of the routine in the child enclave, and the PLIST, TARGET, or SYSTEM setting of the main routine in the child enclave. If a user parameter string was passed to your routine, the user parameter string is extracted from the command-line equivalent for your routine (shown in Table 28 on page 69) and returned to you.

Table 27. Determining the Command-Line Equivalent

Language	Option	Suboption	CMSCALL or SVC LINK on z/VM	system() on z/VM	FETCH/CALL of a PL/I main
C	#pragma runopts (PLIST)	HOST, CMS, MVS	CMS extended argument list (R0)	PARAM=, or the parameter string from the command string passed to system()	Not allowed
C++	PLIST and TARGET compiler options	Default	Not allowed	Not allowed	Not allowed
		PLIST(OS) or TARGET(IMS)	Not allowed	Not allowed	Not allowed
COBOL	N/A	CMS extended argument list (R0)	CMS extended argument list (R0)	Null	

Table 27. Determining the Command-Line Equivalent (continued)

Language	Option	Suboption	CMSCALL or SVC LINK on z/VM	system() on z/VM	FETCH/CALL of a PL/I main
PL/I	SYSTEM compiler option	MVS	Halfword length-prefixed string pointed to R1	Halfword length-prefixed string pointed to by R1	User parameters passed through CALL
		CMS	CMS extended argument list	PARM= or the parameter string from the command string passed to system()	User parameters passed through CALL
		CICS, CMSTPL, IMS, TSO	Not available	Not available	SYSTEM(CICS) not supported; others not available.
Language Environment-conforming assembler	CEENTRY PLIST=	HOST, CMS, MVS	CMS extended argument list (R0)	PARM=, or the parameter string from the command string passed to system()	Not allowed

If Table 27 on page 68 indicates that a parameter string was passed to your routine at invocation, the string is extracted from the command-line equivalent listed in the right-hand column of Table 28. The command-line equivalent depends on the language of your routine and the run-time options specified for it.

Table 28. Determining the Order of Run-Time Options and Program Arguments

Language of Routine	Run-Time Options in Effect?	Order of Run-Time Options and Program Arguments
C	#pragma runopts(EXECOPS)	run-time options / user parms
	#pragma runopts(NOEXECOPS)	entire string is user parms
C++	Compiled with EXECOPS (default)	run-time options / user parms
	Compiled with NOEXECOPS	entire string is user parms
COBOL	CBLOPTS(ON)	user parms / run-time options
	CBLOPTS(OFF)	run-time options / user parms
PL/I	PROC OPTIONS(NOEXECOPS) or SYSTEM(CICS IMS TSO) is not specified.	run-time options / user parms
	PROC OPTIONS(NOEXECOPS) is specified, or NOEXECOPS is not specified but SYSTEM (CICS IMS TSO) is. See “PL/I Main Procedure Parameter Passing Considerations” on page 111 for more information on the SYSTEM compile option.	entire string is user parms
Language Environment-conforming assembler	CEENTRY EXECOPS=ON	run-time options / user parms
	CEENTRY EXECOPS=OFF	entire string is user parms

Using Nested Enclaves

Finding the Return and Reason Code from the Enclave

The following list tells where to look for the return and reason codes that are returned to the parent enclave when a child enclave terminates:

- SVC LINK or CMSCALL to a child enclave with a main routine written in any Language Environment-conforming language

If the process was not terminated, the return code is reported in R15. (See “How the Language Environment Enclave Return Code Is Calculated” on page 27 for more information.) The reason code is discarded.

- C's `system()` function

If the target command or program of `system()` cannot be started, the system load service return code is returned as the function value of `system()`. Otherwise, the return code of the created enclave is reported as the function value of `system()`, and the reason code is discarded.

- FETCH and CALL of a fetchable main

Normally, the enclave return code and reason code are discarded when control returns to a parent enclave from a child enclave. However, in the parent enclave, you can specify the `OPTIONS(ASSEMBLER RETCODE)` option of the entry constant for the main procedure of the child enclave. This causes the enclave return code of the child enclave to be saved in R15 as the PL/I return code. You can then interrogate that value by using the `PLIRETV` built-in function in the parent enclave.

Assembler User Exit

An assembler user exit (`CEEBXITA`) is driven for enclave initialization and enclave termination regardless of whether the enclave is the first enclave created in the process or a nested enclave. The assembler user exit differentiates between first and nested enclave initialization.

Message File

If the child enclave opens a message file, the file is closed when that enclave terminates.

OpenExtensions Considerations

The following restrictions must be considered when running with `POSIX(OFF)` or `POSIX(ON)`:

- In Language Environment, a process can have only one enclave that is running with `POSIX(ON)`, and that enclave must be the first enclave if that process contains multiple enclaves. All nested enclaves must be enclaves with `POSIX(OFF)`.
- The `spawn()` function is only allowed from a `POSIX(ON)` enclave. This applies to implicit `spawn()` resulting from a `system()` mapped to a `spawn()`, and to explicit `spawn()` functions.
- `C exec()` can be issued only from a single-thread enclave.

Any violations of the above restrictions result in a severity 3 condition being generated.

AMODE Considerations

`ALL31` should have the same setting for all enclaves within a process. You cannot invoke a nested enclave that requires `ALL31(OFF)` from an enclave running with `ALL31(ON)`.

Part 2. Language Environment Debugging Guide

Chapter 9. Debugging C/C++ Routines

The information that follows is additional for use with z/VM when using z/OS: *Language Environment Debugging Guide*.

This chapter provides specific information to help you debug applications that contain one or more C/C++ routines.

Debugging C/C++ Input/Output Programs

You can use C/C++ conventions such as `__amrc` and `perror()` when you debug I/O operations.

`__last_op` Values

The `__last_op` field is the most important of the `__amrc` fields. It defines the last I/O operation C/C++ was performing at the time of the I/O error. You should note that the structure is neither cleared nor set by non-I/O operations, so querying this field outside of a SIGIOERR handler should only be done immediately after I/O operations. Table 29 lists `__last_op` values you could receive and where to look for further information.

Table 29. `__last_op` Values and Diagnosis Information

Value	Further Information
<code>__IO_INIT</code>	Will never be seen by SIGIOERR exit value given at initialization.
<code>__BSAM_OPEN</code>	Sets <code>__error</code> with return code from OS OPEN macro.
<code>__BSAM_CLOSE</code>	Sets <code>__error</code> with return code from OS CLOSE macro.
<code>__BSAM_READ</code>	No return code (either <code>__abend</code> (<code>errno == 92</code>) or <code>__msg</code> (<code>errno == 66</code>) filled in).
<code>__BSAM_NOTE</code>	NOTE returned 0 unexpectedly, no return code.
<code>__BSAM_POINT</code>	This will not appear as an error lastop.
<code>__BSAM_WRITE</code>	No return code (either <code>__abend</code> (<code>errno == 92</code>) or <code>__msg</code> (<code>errno == 65</code>) filled in).
<code>__BSAM_CLOSE_T</code>	Sets <code>__error</code> with return code from OS CLOSE TYPE=T.
<code>__BSAM_BLDL</code>	Sets <code>__error</code> with return code from OS BLDL macro.
<code>__BSAM_STOW</code>	Sets <code>__error</code> with return code from OS STOW macro.
<code>__TGET_READ</code>	Sets <code>__error</code> with return code from TSO TGET macro.
<code>__TPUT_WRITE</code>	Sets <code>__error</code> with return code from TSO TPUT macro.
<code>__IO_DEVTYPE</code>	Sets <code>__error</code> with return code from I/O DEVTYPE macro.
<code>__IO_RDJFCB</code>	Sets <code>__error</code> with return code from I/O RDJFCB macro.
<code>__IO_TRKCALC</code>	Sets <code>__error</code> with return code from I/O TRKCALC macro.
<code>__IO_OBTAIN</code>	Sets <code>__error</code> with return code from I/O CAMLST OBTAIN.
<code>__IO_LOCATE</code>	Sets <code>__error</code> with return code from I/O CAMLST LOCATE.
<code>__IO_CATALOG</code>	Sets <code>__error</code> with return code from I/O CAMLST CAT. The associated macro is CATALOG.
<code>__IO_UNCATALOG</code>	Sets <code>__error</code> with return code from I/O CAMLST UNCAT. The associated macro is CATALOG.
<code>__IO_RENAME</code>	Sets <code>__error</code> with return code from I/O CAMLST RENAME.

Table 29. `__last_op` Values and Diagnosis Information (continued)

Value	Further Information
<code>__SVC99_ALLOC</code>	Sets <code>__alloc</code> structure with info and error codes from SVC 99 allocation.
<code>__SVC99_ALLOC_NEW</code>	Sets <code>__alloc</code> structure with info and error codes from SVC 99 allocation of NEW file.
<code>__SVC99_UNALLOC</code>	Sets <code>__unalloc</code> structure with info and error codes from SVC 99 unallocation.
<code>__C_TRUNCATE</code>	Set when C or C++ truncates output data. Usually this is data written to a text file with no newline such that the record fills up to capacity and subsequent characters cannot be written. For a record I/O file this refers to an <code>fwrite()</code> writing more data than the record can hold. Truncation is always rightmost data. There is no return code.
<code>__C_FCBCHECK</code>	Set when C or C++ FCB is corrupted. This is due to a pointer corruption somewhere. File cannot be used after this.
<code>__C_DBCS_TRUNCATE</code>	This occurs when writing DBCS data to a text file and there is no room left in a physical record for anymore double byte characters. A new-line is not acceptable at this point. Truncation will continue to occur until an SI is written or the file position is moved. Cannot happen if <code>MB_CUR_MAX</code> is 1.
<code>__C_DBCS_SO_TRUNCATE</code>	This occurs when there is not enough room in a record to start any DBCS string or else when a redundant SO is written to the file before an SI. Cannot happen if <code>MB_CUR_MAX</code> is 1.
<code>__C_DBCS_SI_TRUNCATE</code>	This occurs only when there was not enough room to start a DBCS string and data was written anyways, with an SI to end it. Cannot happen if <code>MB_CUR_MAX</code> is 1.
<code>__C_DBCS_UNEVEN</code>	This occurs when an SI is written before the last double byte character is completed, thereby forcing C or C++ to fill in the last byte of the DBCS string with a padding byte <code>X'FE'</code> . Cannot happen if <code>MB_CUR_MAX</code> is 1.
<code>__C_CANNOT_EXTEND</code>	This occurs when an attempt is made to extend a file that allows writing, but cannot be extended. Typically this is a member of a partitioned data set being opened for update.
<code>__VSAM_OPEN_FAIL</code>	Set when a low level VSAM OPEN fails, sets <code>__rc</code> and <code>__fdbk</code> fields in the <code>__amrc</code> struct.
<code>__VSAM_OPEN_ESDS</code>	Does not indicate an error; set when the low level VSAM OPEN succeeds, and the file type is ESDS.
<code>__VSAM_OPEN_RRDS</code>	Does not indicate an error; set when the low level VSAM OPEN succeeds, and the file type is ESDS.
<code>__VSAM_OPEN_KSDS</code>	Does not indicate an error; set when the low level VSAM OPEN succeeds, and the file type is ESDS.
<code>__VSAM_OPEN_ESDS_PATH</code>	Does not indicate an error; set when the low level VSAM OPEN succeeds, and the file type is ESDS.
<code>__VSAM_OPEN_KSDS_PATH</code>	Does not indicate an error; set when the low level VSAM OPEN succeeds, and the file type is ESDS.
<code>__VSAM_MODCB</code>	Set when a low level VSAM MODCB macro fails, sets <code>__rc</code> and <code>__fdbk</code> fields in the <code>__amrc</code> struct.
<code>__VSAM_TESTCB</code>	Set when a low level VSAM TESTCB macro fails, sets <code>__rc</code> and <code>__fdbk</code> fields in the <code>__amrc</code> struct.

Table 29. `__last_op` Values and Diagnosis Information (continued)

Value	Further Information
<code>__VSAM_SHOWCB</code>	Set when a low level VSAM SHOWCB macro fails, sets <code>__rc</code> and <code>__fdbk</code> fields in the <code>__amrc</code> struct.
<code>__VSAM_GENCB</code>	Set when a low level VSAM GENCB macro fails, sets <code>__rc</code> and <code>__fdbk</code> fields in the <code>__amrc</code> struct.
<code>__VSAM_GET</code>	Set when the last op was a low level VSAM GET; if the GET fails, sets <code>__rc</code> and <code>__fdbk</code> in the <code>__amrc</code> struct.
<code>__VSAM_PUT</code>	Set when the last op was a low level VSAM PUT; if the PUT fails, sets <code>__rc</code> and <code>__fdbk</code> in the <code>__amrc</code> struct.
<code>__VSAM_POINT</code>	Set when the last op was a low level VSAM POINT; if the POINT fails, sets <code>__rc</code> and <code>__fdbk</code> in the <code>__amrc</code> struct.
<code>__VSAM_ERASE</code>	Set when the last op was a low level VSAM ERASE; if the ERASE fails, sets <code>__rc</code> and <code>__fdbk</code> in the <code>__amrc</code> struct.
<code>__VSAM_ENDREQ</code>	Set when the last op was a low level VSAM ENDREQ; if the ENDREQ fails, sets <code>__rc</code> and <code>__fdbk</code> in the <code>__amrc</code> struct.
<code>__VSAM_CLOSE</code>	Set when the last op was a low level VSAM CLOSE; if the CLOSE fails, sets <code>__rc</code> and <code>__fdbk</code> in the <code>__amrc</code> struct.
<code>__QSAM_GET</code>	<code>__error</code> is not set (if abend (<code>errno == 92</code>), <code>__abend</code> is set, otherwise if read error (<code>errno == 66</code>), look at <code>__msg</code> .
<code>__QSAM_PUT</code>	<code>__error</code> is not set (if abend (<code>errno == 92</code>), <code>__abend</code> is set, otherwise if write error (<code>errno == 65</code>), look at <code>__msg</code> .
<code>__QSAM_TRUNC</code>	This is an intermediate operation. You will only see this if an I/O abend occurred.
<code>__QSAM_FREEPOL</code>	This is an intermediate operation. You will only see this if an I/O abend occurred.
<code>__QSAM_CLOSE</code>	Sets <code>__error</code> to result of OS CLOSE macro.
<code>__QSAM_OPEN</code>	Sets <code>__error</code> to result of OS OPEN macro.
<code>__CMS_OPEN</code>	Sets <code>__error</code> to result of FSOPEN.
<code>__CMS_CLOSE</code>	Sets <code>__error</code> to result of FSCLOSE.
<code>__CMS_READ</code>	Sets <code>__error</code> to result of FSREAD.
<code>__CMS_WRITE</code>	Sets <code>__error</code> to result of FSWRITE.
<code>__CMS_STATE</code>	Sets <code>__error</code> to result of FSSTATE.
<code>__CMS_ERASE</code>	Sets <code>__error</code> to result of FSERASE.
<code>__CMS_RENAME</code>	Sets <code>__error</code> to result of CMS RENAME command.
<code>__CMS_EXTRACT</code>	Sets <code>__error</code> to result of DMS EXTRACT call.
<code>__CMS_LINERD</code>	Sets <code>__error</code> to result of LINERD macro.
<code>__CMS_LINEWRT</code>	Sets <code>__error</code> to result of LINEWRT macro.
<code>__CMS_QUERY</code>	<code>__error</code> is not set.
<code>__HSP_CREATE</code>	Indicates last op was a DSPSERV CREATE to create a hiperspace for a hiperspace memory file. If CREATE fails, stores abend code in <code>__amrc_code__abend__syscode</code> , reason code in <code>__amrc_code__abend__rc</code> .
<code>__HSP_DELETE</code>	Indicates last op was a DSPSERV DELETE to delete a hiperspace for a hiperspace memory file during termination. If DELETE fails, stores abend code in <code>__amrc_code__abend__syscode</code> , reason code in <code>__amrc_code__abend__rc</code> .

Table 29. `__last_op` Values and Diagnosis Information (continued)

Value	Further Information
<code>__HSP_READ</code>	Indicates last op was a HSPSERV READ from a hiperspace. If READ fails, stores abend code in <code>__amrc_code_abend_syscode</code> , reason code in <code>__amrc_code_abend_rc</code> .
<code>__HSP_WRITE</code>	Indicates last op was a HSPSERV WRITE to a hiperspace. If WRITE fails, stores abend code in <code>__amrc_code_abend_syscode</code> , reason code in <code>__amrc_code_abend_rc</code> .
<code>__HSP_EXTEND</code>	Indicates last op was a HSPSERV EXTEND during a write to a hiperspace. If EXTEND fails, stores abend code in <code>__amrc_code_abend_syscode</code> , reason code in <code>__amrc_code_abend_rc</code> .
<code>__CICS_WRITEQ_TD</code>	Sets <code>__error</code> with error code from EXEC CICS WRITEQ TD.
<code>__LFS_OPEN</code>	Sets <code>__error</code> with reason code from HFS services. Reason code from HFS services must be broken up. The low order 2 bytes can be looked up in <i>z/OS UNIX System Services Programming: Assembler Callable Services Reference</i> .
<code>__LFS_CLOSE</code>	Sets <code>__error</code> with reason code from HFS services. Reason code from HFS services must be broken up. The low order 2 bytes can be looked up in <i>z/OS UNIX System Services Programming: Assembler Callable Services Reference</i> .
<code>__LFS_READ</code>	Sets <code>__error</code> with reason code from HFS services. Reason code from HFS services must be broken up. The low order 2 bytes can be looked up in <i>z/OS UNIX System Services Programming: Assembler Callable Services Reference</i> .
<code>__LFS_WRITE</code>	Sets <code>__error</code> with reason code from HFS services. Reason code from HFS services must be broken up. The low order 2 bytes can be looked up in <i>z/OS UNIX System Services Programming: Assembler Callable Services Reference</i> .
<code>__LFS_LSEEK</code>	Sets <code>__error</code> with reason code from HFS services. Reason code from HFS services must be broken up. The low order 2 bytes can be looked up in <i>z/OS UNIX System Services Programming: Assembler Callable Services Reference</i> .
<code>__LFS_FSTAT</code>	Sets <code>__error</code> with reason code from HFS services. Reason code from HFS services must be broken up. The low order 2 bytes can be looked up in <i>z/OS UNIX System Services Programming: Assembler Callable Services Reference</i> .

Using `__errno2()` to Diagnose Application Problems

Use `__errno2()` when diagnosing problems in a z/OS UNIX or z/VM OpenExtensions application. This function enables C/C++ application programs to access diagnostic information returned to the C/C++ run-time library from an underlying kernel callable service. `__errno2()` returns the reason code of the last failing kernel callable service called by the C/C++ run-time library. The returned value is intended for diagnostic display purposes only. The function call is always successful.

Note: Since the `__errno2()` function returns the reason code of the kernel callable service that last failed, and not all function calls invoke the kernel, the value returned by `__errno2()` may be misleading.

Figure 7 is an example of a routine using `__errno2()`.

```
#include <stdio.h>
#include <errno.h>
FILE *myfopen(const char *fn, const char *mode) {
    FILE *f;
    f = fopen(fn,mode);
    if (f==NULL) {
        perror("fopen() failed");
        printf("__errno2 = %08x\n", __errno2());
    }
    return(f);
}
```

Figure 7. Example of a Routine Using `__errno2()`

Figure 8 is an example of a routine using the environment variable `_EDC_ADD_ERRNO2`, and Figure 9 shows the sample output from that routine.

```
#include <stdio.h>
#include <errno.h>

int main(void) {
    FILE *fp;

    /* add errno2 to perror message */
    setenv("_EDC_ADD_ERRNO2","1",1);

    fp = fopen("testfile.dat", "r");
    if (fp == NULL)
        perror("fopen error");
}
```

Figure 8. Example of a Routine Using `_EDC_ADD_ERRNO2`

```
fopen error: EDC5129I No such file or directory.
(errno2=0x05620062)
```

Figure 9. Sample Output of a Routine Using `_EDC_ADD_ERRNO2`

Generating a Language Environment Dump of a C/C++ Routine

You can use either the CEE3DMP callable service or the `cdump()`, `csnap()`, and `ctrace()` C/C++ functions to generate a Language Environment dump of C/C++ routines. These C/C++ functions call CEE3DMP with specific options.

cdump()

You can generate useful diagnostic information by using the `cdump()` function. `cdump()` produces a main storage dump with the activation stack. This is equivalent to calling CEE3DMP with the option string: `TRACEBACK BLOCKS VARIABLES FILES STORAGE STACKFRAME(ALL) CONDITION ENTRY`.

When `cdump()` is invoked from a user routine, the C/C++ library issues an OS SNAP macro to obtain a dump of virtual storage. The first invocation of `cdump()` results in a SNAP identifier of 0. For each successive invocation, the ID is increased by one to a maximum of 256, after which the ID is reset to 0.

Under z/VM, the definition statement is:

```
FILEDEF CEESNAP PRINTER (NOCHANGE PER
```

If the data set is not defined, or is not usable for any reason, `cdump()` returns a failure code of 1. This occurs even if the call to CEE3DMP is successful.

If the SNAP is not successful, the CEE3DMP DUMP file displays the following message:

```
Snap was unsuccessful
```

If the SNAP is successful, CEE3DMP displays this message:

```
Snap was successful; snap ID = nnn
```

Where *nnn* corresponds to the SNAP identifier described above. An unsuccessful SNAP does not result in an incrementation of the identifier.

Because `cdump()` returns a code of 0 only if the SNAP was successful or 1 if it was unsuccessful, you cannot distinguish whether a failure of `cdump()` occurred in the call to CEE3DMP or SNAP. A return code of 0 is issued only if both SNAP and CEE3DMP are successful.

A successful SNAP results in a large quantity of output. In addition to a SNAP dump, an Language Environment formatted dump is also taken.

csnap()

The `csnap()` function produces a condensed storage dump. `csnap()` is equivalent to calling CEE3DMP with the option string: TRACEBACK FILES BLOCKS VARIABLES NOSTORAGE STACKFRAME(ALL) CONDITION ENTRY.

To use these functions, you must add `#include <ctest.h>` to your C/C++ code. The dump is directed to output *dumpname*, which is specified in a FILEDEF CEEDUMP command in z/VM.

`cdump()`, `csnap()`, and `ctrace()` all return a 1 code in the SPC environment because they are not supported in SPC.

For more details about the syntax of these functions, refer to the *XL C/C++ for z/VM: Runtime Library Reference*.

Chapter 10. Diagnosing Problems with Language Environment

The information that follows is additional for use with z/VM when using z/OS:
Language Environment Debugging Guide.

This chapter provides information for diagnosing problems in the Language Environment product. It helps you determine if a correction for a product failure similar to yours has been previously documented. If the problem has not been previously reported, it tells you how to open a Problem Management Record (PMR) to report the problem to IBM, and if the problem is with an IBM product, what documentation you need for an Authorized Program Analysis Report (APAR).

Diagnosis Checklist

Step through each of the items in the diagnosis checklist below to see if they apply to your problem. The checklist is designed to either solve your problem or help you gather the diagnostic information required for determining the source of the error. It can also help you confirm that the suspected failure is not a user error; that is, it was not caused by incorrect usage of the Language Environment product or by an error in the logic of the routine.

1. If your failing application contains programs that were changed since they last ran successfully, review the output of the compile or assembly (listings) for any unresolved errors.
2. If there have not been any changes in your applications, check the output (console logs) for any messages from the failing run.
3. Check the message prefix to identify the component that issued the message. This can help you determine the cause of the problem. Following are some of the prefixes and their respective origins.

EDC The prefix for C/C++ messages. The following series of messages are from the C/C++ run-time component of Language Environment: 5000 (except for 5500, which are from the DSECT utility), 6000, and 7000.

IGZ The prefix for messages from the COBOL run-time component of Language Environment.

IBM The prefix for messages from the PL/I run-time component of Language Environment.

CEE The prefix for messages from the common run-time component of Language Environment.

4. For any messages received, check for recommendations in the “Programmer Response” sections of the messages in this manual.
5. Verify that abends are caused by product failures and not by program errors. See the appropriate chapters in this manual for a list of Language Environment-related abend codes.
6. Your installation may have received an IBM Program Temporary Fix (PTF) for the problem. Verify that you have received all issued PTFs and have installed them, so that your installation is at the most current maintenance level.
7. The preventive service planning (PSP) bucket, an online database available to IBM customers through IBM service channels, gives information about product installation problems and other problems. Check to see whether it contains information related to your problem.
8. Narrow the source of the error.

- If a Language Environment dump is available, locate the traceback in the Language Environment dump for the source of the problem.
 - If a system dump is taken on z/VM, follow the save area chain to find out the name of the failing module and whether IBM owns it. For information on finding the routine name, see *z/OS: Language Environment Debugging Guide*.
9. After you identify the failure, consider writing a small test case that re-creates the problem. The test case could help you determine whether the error is in a user routine or in the Language Environment product. Do not make the test case larger than 75 lines of code. The test case is not required, but it could expedite the process of finding the problem.
If the error is not a Language Environment failure, refer to the diagnosis procedures for the product that failed.
 10. Record the conditions and options in effect at the time the problem occurred. Compile your program with the appropriate options to obtain an assembler listing and data map. If possible, obtain the LOAD/GENMOD map if running on z/VM. Note any changes from the previous successful compilation or run. For an explanation of compiler options, refer to the compiler-specific programming guide.
 11. If you are experiencing a no-response problem, try to force a dump. Under z/VM in the CP mode, enter the DUMP command.
 12. Record the sequence of events that led to the error condition and any related programs or files. It is also helpful to record the service level of the compiler associated with the failing program.

Part 3. Language Environment Run-Time Messages

Chapter 11. C/C++ Run-Time Messages

The information that follows is additional for use with z/VM when using z/OS: *Language Environment Run-Time Messages*.

The following run-time messages pertain to C/C++. Each message is followed by an explanation describing the condition that caused the message, a programmer response suggesting how you might prevent the message from occurring again, and a system action indicating how the system responds to the condition that caused the message.

The messages also contain a symbolic feedback code, which represents the first 8 bytes of a 12-byte condition token. You can think of the symbolic feedback code as the nickname for a condition. As such, the symbolic feedback code can be used in user-written condition handlers to screen for a given condition, even if it occurs at different locations in an application.

The messages in this section contain alphabetic suffixes that have the following meaning:

I Informational message
W Warning message
E Error message
S Severe error message
C Critical error message

EDC5230I ESM error.

Explanation: An internal External Security Manager (ESM) error occurred. This message is equivalent to the OS/390 UNIX System Services errno ECMSESMERR.

Programmer response: Report this problem to your system programmer.

System action: Messages are displayed on the file pool server operator console indicating the error and z/VM processing continues.

Problem determination: EDC53E

EDC6000E The raise() function was issued for the signal SIGFPE.

Explanation: The program has invoked the raise() function with the SIGFPE signal specified and the default action specified.

Programmer response: None.

System action: The program is terminated and a traceback or dump is issued, depending on the TERMTHDACT run-time option. A return code of 3000000 is returned.

Problem determination: EDC5RG

EDC6001E The raise() function was issued for the signal SIGILL.

Explanation: The program has invoked the raise()

function with the SIGILL signal specified and the default action specified.

Programmer response: None.

System action: The program is terminated and a traceback or dump is issued, depending on the TERMTHDACT run-time option. A return code of 3000000 is returned.

Problem determination: EDC5RH

EDC6002E The raise() function was issued for the signal SIGSEGV.

Explanation: The program has invoked the raise() function with the SIGSEGV signal specified and the default action specified.

Programmer response: None.

System action: The program will be terminated and a traceback or dump is issued, depending on the TERMTHDACT run-time option. A return code of 3000000 is returned.

Problem determination: EDC5RI

EDC6003E The raise() function was issued for the signal SIGABND.

Explanation: The program has invoked the raise() function with the SIGABND signal specified and the default action specified.

Programmer response: None.

System action: The program will be terminated and a traceback or dump is issued, depending on the TERMTHDACT run-time option. A return code of 3000000 is returned.

Problem determination: EDC5RJ

EDC6004E The raise() function was issued for the signal SIGTERM.

Explanation: The program has invoked the raise() function with the SIGTERM signal specified and the default action specified.

Programmer response: None.

System action: The program will be terminated and a traceback or dump is issued, depending on the TERMTHDACT run-time option. A return code of 3000000 is returned.

Problem determination: EDC5RK

EDC6005E The raise() function was issued for the signal SIGINT.

Explanation: The program has invoked the raise() function with the SIGINT signal specified and the default action specified.

Programmer response: None.

System action: The program will be terminated and a traceback or dump is issued, depending on the TERMTHDACT run-time option. A return code of 3000000 is returned.

Problem determination: EDC5RL

EDC6006E The raise() function was issued for the signal SIGABRT.

Explanation: The program has invoked the raise() function with the SIGABRT signal specified and the default action specified.

Programmer response: None.

System action: The program will be terminated and a traceback or dump is issued, depending on the TERMTHDACT run-time option. A return code of 2000000 is returned.

Problem determination: EDC5RM

EDC6007E The raise() function was issued for the signal SIGUSR1.

Explanation: The program has invoked the raise() function with the SIGUSR1 signal specified and the default action specified.

Programmer response: None.

System action: The program will be terminated and a

traceback or dump is issued, depending on the TERMTHDACT run-time option. A return code of 3000000 is returned.

Problem determination: EDC5RN

EDC6008E The raise() function was issued for the signal SIGUSR2.

Explanation: The program has invoked the raise() function with the SIGUSR2 signal specified and the default action specified.

Programmer response: None.

System action: The program will be terminated and a traceback or dump is issued, depending on the TERMTHDACT run-time option. A return code of 3000000 is returned.

Problem determination: EDC5RO

EDC6009E The raise() function was issued for the signal SIGIOERR.

Explanation: The program has invoked the raise() function with the SIGIOERR signal specified and the default action specified.

Programmer response: None.

System action: The program will be terminated and a traceback or dump is issued, depending on the TERMTHDACT run-time option. A return code of 3000000 is returned.

Problem determination: EDC5RP

Chapter 12. COBOL Run-Time Messages

The information that follows is additional for use with z/VM when using z/OS: *Language Environment Run-Time Messages*.

The following messages pertain to COBOL. Each message is followed by an explanation describing the condition that caused the message, a programmer response suggesting how you might prevent the message from occurring again, and a system action indicating how the system responds to the condition that caused the message.

The messages also contain a symbolic feedback code, which represents the first 8 bytes of a 12-byte condition token. You can think of the symbolic feedback code as the nickname for a condition. As such, the symbolic feedback code can be used in user-written condition handlers to screen for a given condition, even if it occurs at different locations in an application.

The messages in this section contain alphabetic suffixes that have the following meaning:

I	Informational message
W	Warning message
E	Error message
S	Severe error message
C	Critical error message

For more COBOL run-time messages, see *z/OS: Language Environment Run-Time Messages*

IGZ0189S Program *pgmname* cannot be run in this operating system environment.

Explanation: The program contains features that are not supported in this operating system environment. For example, when running on CMS, the following features are not supported:

- programs compiled with the DLL compiler option
- programs compiled with the ARITH(EXTEND) compiler option
- programs compiled with Enterprise COBOL for z/OS and OS/390 V3R1 and later

Programmer response: Modify the program to use supported features for the environment or run the program in the appropriate environment.

System action: The application was terminated.

Problem determination: IGZ05T

Part 4. Customizing

Chapter 13. Customizing

Once the product has been installed, it can be customized using the CUSTLE EXEC. This EXEC will do the following:

1. Prompt you for the area you wish to customize:
 - Runtime Options
 - User Exit Options
 - 'C' Component Locale Time Information
 - Saved Segments Components
 - COBOL Reusable environment
2. Invoke an 'XEDIT' session for the specific customization component requested;
3. Re-assemble, if required, component customized;
4. Rebuild required modules using the specific VMSES/E part handler.

Note: The CUSTLE EXEC requires that the High Level Assembler program (HLASM) be available. It must be on a disk that you have accessed as A, B, C, D, S or Y.

To run the CUSTLE EXEC you must be on a userid that has access to the VMSES code (the default disk is the MAINT 5E5 disk). If you are logged on to the MAINT userid, the 5E5 is normally accessed as filemode B. Specify a PPF name (such as SERVP2P or ZVM) and the LE component name (usually LE or LESFS). The following screen is displayed:

```
Language Environment for z/VM
Version 5 Release 4 Mod 0

1) Run Time Options
2) User Exits
3) "C" Locale Time Info
4) Named Saved Segments (NSS)
5) COBOL Reusable Environment

Enter number of option you wish to change or

Enter "END or QUIT" to Exit the customization.
```

Figure 10. Customization EXEC - Panel 1

Updating Run-Time Options

Run-time options are updated by invoking the customization EXEC which puts you into an XEDIT session of CEEDOPT ASSEMBLE. After you update and file CEEDOPT, the EXEC assembles it (using HLASM) and if the assembly is successful, will then rebuild the modules in which it is included. Modules which will be rebuilt are CEEBINIT, CEEBPICI, CEEPIPI, and CEEPLPKA, all of which are in Build List "CEEBLMOD". See *z/OS: Language Environment Programming Reference* for more information. Once the modules have been rebuilt, you will be reminded to rebuild the SCEE/SCEEX segments.

Updating User Exit Options

The assembler user exit is updated by invoking the customization EXEC which puts you into an XEDIT session of CEEBXITB ASSEMBLE. After you update and file CEEBXITB, the EXEC assembles it (using HLASM) and if the assembly is successful, will then rebuild the component in which it is included. Modules which will be rebuilt are CEEBINIT, CEEBPICI and CEEPIPI all of which are in Build List "CEEBLMOD". Once the modules have been rebuilt, you will be reminded to rebuild the SCEE/SCEEX segments.

C Component Locale Time Information

Note

Due to the size and having to rebuild the SCEERUN LOADLIB for this option, your "A" disk, which z/VM uses as an interim work disk during the rebuild, must have at least 20 cylinders on a 3390, or equivalent, of unused (free) space.

C locale time information is used for options such as Time Zone name and Daylight Savings Time starting dates.

Locale time is updated by editing a file named 'EDCLOCI'. The EXEC will put you into an XEDIT session of EDCLOCI ASSEMBLE and after updates are completed it is filed and then assembled using HLASM. Once successfully assembled, the EXEC will rebuild the required components and the C locale time is updated. Once the modules have been rebuilt, you will be reminded to rebuild the SCEE/SCEEX segments.

Updating Saved Segments

After successfully installing Language Environment, you can load certain routines into Saved Segments on z/VM. Placing routines into Saved Segments reduces overall system storage requirements by making the routines sharable. Also, initiation/termination (init/term) time is reduced for each application, since load time decreases.

LE includes two build lists, CEEBLSGA and CEEBLSGB, plus the necessary LSEG files required to install specific routines of LE into segments. By selecting option 4 in the customization exec, these individual build lists can be tailored to load only specific routines of the LE component (for example, commonly used COBOL, PL/I, or C routines) into segments. Each build list contains comments that identify these routines and help tailor the segment install.

Customizing can be accomplished by either commenting or uncommenting the appropriate LOADFUNC component statement(s) or by adding new LOADFUNC statements into the build list. An asterisk (*) inserted in the first column of any LOADFUNC statement will eliminate that component from being included while deleting one from the first column will include the component. In the following example, the PL/I routines (IBMLIB1, IBMRCOMP, and IBMRPTLA) which are normally installed below the line, and thus included in the CEEBLSGB build list, will be eliminated from the saved segment environment.

```
*****  
*                LANGUAGE ENVIRONMENT for z/VM                *  
*                Version 4 Release 4 Modification 0            *  
*                                                                *
```

```

*           Licensed Materials -- Property of IBM           *
*           5739-A03 (C) Copyright IBM Corporation 1997, 2003 *
*           All Rights Reserved                             *
*****
*           Build List for 'SCEE PSEG' Saved Segment (Below line) *
*           "LE/370" Environment                             *
*****
*
:FORMAT. 2
*
:OBJNAME. SCEE.SEGMENT
:BLDREQ.  CEEBLMOD.CEEBINIT.MODULE
          CEEBLMOD.CEEBLIIA.MODULE
          CEEBLMOD.CEEPIPI.MODULE
          CEEBLMOD.CEEBPICI.MODULE
          EDCBLSP2
*
          IBMBLMOD.IBMRCOMP.MODULE
*
          IBMBLMOD.IBMRLIB1.MODULE
*
          IBMBLMOD.IBMRPTLA.MODULE
:GLOBAL. TXTLIB SCEESPC
:OPTIONS. LOADFUNC ( LSEG CEEBINIT )
          LOADFUNC ( LSEG CEEBLIIA )
          LOADFUNC ( LSEG CEEPIPI )
          LOADFUNC ( LSEG CEEBPICI )
*
          LOADFUNC ( LSEG IBMRLIB1 )
*
          LOADFUNC ( LSEG IBMRCOMP )
*
          LOADFUNC ( LSEG IBMRPTLA )
:EOBJNAME.
*

```

To reinstate routines in the saved segments, remove the asterisk and regenerate the segments. To include other routines in saved segments, add the appropriate LOADFUNC statement into the respective build list.

Updating the COBOL Component Reusable Environment

COBOL's reusable environment behavior is updated by invoking the customization EXEC which puts you into an XEDIT session of IGZERREO ASSEMBLE. After you update and file IGZERREO, the EXEC assembles it (using HASM) and if the assembly is successful, will then prompt you to see if you want to rebuild the component in which it is included. The module that will be rebuilt is CEEEV005 which is in build list IGZBLMOD.

The COBOL reusable environment behavior can be modified to control how program checks are handled when they occur in a non-Language Environment-conforming driver. The COBOL reusable environment is established with the RTEREUS run-time option or a call to either ILBOSTP0 or IGZERRE INIT.

With the IBM-supplied default setting for COBOL's reusable environment behavior (IGZERREO with REUSENV=COMPAT), when a program check occurs while the reusable environment is dormant (that is, between a GOBACK from a top level COBOL program to the non-Language Environment conforming assembler driver and the next call to a COBOL program), a S0Cx abend will occur. This behavior is compatible with the VS COBOL II and OS/VS COBOL run-times, but it significantly impacts the performance when a COBOL/370 or COBOL for MVS & VM program is invoked repeatedly in a COBOL reusable environment. The performance degradation is caused by Language Environment issuing an ESPIE RESET when the reusable environment becomes dormant and then an ESPIE SET upon reentering the reusable environment.

COBOL's reusable environment behavior can be modified (IGZERRRO with REUSENV=OPT) so that all program checks will be intercepted by Language Environment, even those that occur while the reusable environment is dormant. In this case, a program check that occurs while the reusable environment is dormant will result in a 4036 abend from Language Environment. However, since Language Environment does not have to issue the ESPIE RESET and ESPIE SET between invocations of the COBOL program, this can be faster than using REUSENV=COMPAT.

Modifying the behavior of the COBOL Reusable Environment

Modify the IGZRREOP macro invocation, depending on the function that you want. To run with VS COBOL II and OS/VS COBOL run-time compatibility mode (that is, the user has control of program checks that occur when the COBOL reusable environment is dormant, resulting in an additional performance cost), use:

```
IGZRREOP REUSENV=COMPAT
```

To run with optimum performance (Language Environment intercepts all program checks that occur when the COBOL reusable environment is dormant and converts them to a 4036 abend, resulting in improved performance), use:

```
IGZRREOP REUSENV=OPT
```

Appendix A. Prelinking an Application

This appendix describes how to prelink your programs under Language Environment. Unless otherwise indicated, the prelinking process applies to C and COBOL in z/VM.

The Language Environment prelinker performs mapping of names, manages writable static areas, collects initialization information, and combines the object modules that form an application into a single object module that can be link-edited or loaded for execution.

Note: The prelink step in creating an executable program can be eliminated. The binder is available to be able to directly receive the output of the C, COBOL, and PL/I compilers, thus eliminating the requirement for the prelink step. The advantage of using the binder is that the resulting executable program is fully rebindable. For information on how to use the binder, see *z/VM: Program Management Binder for CMS*.

For information on how to build and use DLLs, see *z/OS: Language Environment Programming Guide*.

Which Programs Need to Be Prelinked

The prelink step is required when an executable program is built on z/VM, or if it utilizes the system programming facilities of C. The prelink step may be eliminated since the binder can handle the output of the C and COBOL compilers. If the link-edit process is performed by the linkage editor then the prelink step is required.

You should not use the pre-linker with XPLINK programs because XPLINK programs require the GOFF binder format and GOFF is not supported by the pre-linker. Also, the C compiler creates GOFF object code when the XPLINK compiler option is specified.

The following list identifies programs which may need to be prelinked before the link-edit step of creating an executable program.

- Modules which must be processed with the linkage editor rather than the binder
- Programs which utilize the system programming facilities of C.
- Non-XPLINK C programs compiled with any of the following compiler options:
 - RENT
 - LONGNAME
 - DLL
- COBOL programs compiled with any of the following compiler options:
 - PGMNAME(LONGMIXED)
 - PGMNAME(LONGUPPER)
- C programs compiled to run under OpenExtensions for z/VM

Only C object modules that do not refer to writable static, do not contain the LONGNAME option, and do not contain DLL code can be processed by the linkage editor. You do not need to prelink naturally reentrant programs. For more information, see *z/OS: Language Environment Programming Guide*.

If you need to link-edit together object modules and load modules, prelink the object modules through the prelinker in a single step, and then link-edit with the load modules in a separate link-edit step. This is because the prelinking process can only process object modules.

What the Prelinker Does

The prelinker performs the following functions:

- Collects information for run-time initialization, including data initialization for C and DLL initialization information.
- For C object modules compiled with RENT, the prelinker:
 - Combines writable static initialization information
 - Assigns relative offsets to objects in writable static storage
 - Removes writable static name and relocation information
- For programs containing longnames, such as C programs compiled with LONGNAME and COBOL programs compiled with PGMNAME(LONGMIXED) or PGMNAME(LONGUPPER), the prelinker maps LONGNAME option to SHORTNAME option on output.
- For programs that use DLLs, the prelinker:
 - Generates a function descriptor in writable static for each DLL referenced function
 - Generates a variable descriptor for each DLL referenced variable
 - Generates an IMPORT control statement for each exported function and variable
 - Generates internal information for the load module that describes symbols that are exported to and imported from other load modules
 - Combines static DLL initialization information
 - Uses longnames to resolve exported and imported symbols

Prelinking Process

Input to the prelinker includes the following:

- Primary input: those object modules specified on the command line
- Secondary input: input from automatic library calls
- Input specified in one or more INCLUDE control statements processed in primary and secondary input

The process of resolving or including input from these sources depends on the type of the source, and the current input and prelink options.

Primary Input

When an object module name SNAME is specified on the command line, the following process occurs:

- If it exists, it is immediately resolved by reading SNAME TEXT.
- If the LIBE option is in effect, then SNAME is immediately resolved by reading the member of the first TXTLIB found in the GLOBAL list that has the same member name, or alias name.
- If SNAME is still unresolved, it could be subsequently resolved if a defined function or variable called SNAME is encountered in input.

INCLUDE Control Statements

For the INCLUDE *ddname* () and INCLUDE *ddname* (*member*) forms, an attempt is made to read the *ddname* or member of the *ddname* (whichever is specified). This request is resolved if the read is successful.

For the INCLUDE SNAME form, the input is resolved using the same algorithm as for primary input.

See “INCLUDE Control Statement” on page 100 for a description of the INCLUDE control statement.

References to Currently Undefined Symbols (External References)

If, during the automatic library call, the symbol was not found to be the name of an existing TXTLIB library routine or TEXT file, then the symbol can subsequently be defined if a function or variable with the same name is encountered.

If the symbol is an L-name that was not resolved by automatic library call and for which a RENAME statement with the SEARCH option exists, the symbol is resolved under the S-name on the RENAME statement by automatic library call. See “RENAME Control Statement” on page 101 for a complete description of the RENAME control statement.

C only: If the symbol is an L-name that was not resolved by previous automatic library call and also corresponds to a C library function or object, the symbol is resolved under the S-name of the symbol. For example, if you do not supply a version of printf(), an attempt would be made to find and use PRINTF in its place as the C library only ships PRINTF.

Unresolved requests generate error or warning messages to the terminal or to the prelinker map.

Writable static references which are not resolved by the prelinker cannot be resolved later. Only the prelinker can be used to resolve writable static. The output object module of the prelinker cannot be used as input to another prelink.

Unresolved references or undefined writable static objects often result if the prelinker is given input object modules produced with a mixture of RENT/NORENT or LONGNAME/NOLONGNAME options.

Processing the Prelinker Automatic Library Call

The following hierarchy is used to resolve a referenced and currently undefined symbol. In all cases, the symbol is only defined if it is contained in the input from this process or in other future input.

- The undefined name is an S-name, for example SNAME.
 - If the AUTO command option is in effect and the reference is not to static external data, SNAME TEXT is read.
 - If the LIBE command option is in effect, the GLOBAL TXTLIBs are searched in order as follows:
 1. If the TXTLIB contains a C370LIB-directory created using the Object Library Utility, and the C370LIB-directory indicates that a defined symbol by that name exists, the member of the TXTLIB containing that symbol is read.
 2. If the TXTLIB does not contain a C370LIB-directory created using the Object Library Utility and the reference is not to static external data, the member or alias, with the same name as SNAME is read.
- The undefined name is an L-name.
 - If the LIBE command option is in effect, the GLOBAL TXTLIBs are searched. If the TXTLIB contains a C370LIB-directory created using the Object Library

Prelinking Applications

Utility, and the C370LIB-directory indicates that a defined symbol by that name exists, the member of the TXTLIB indicated as containing that symbol is read.

Language Environment Prelinker Map

The Language Environment prelinker produces a listing file called the prelinker map when you use the MAP prelinker option (which is the default). As Figure 11 on page 97 shows, the prelinker map contains several individual sections that are only generated if they are applicable.

```
=====
|                               Prelinker Map                               | 1 |
| PLINK:5739A03 V4 R4 M00 IBM z/VM 2003/05/20 13:45:16                    |
=====
```

```
Command Options. . . . . : NONCAL  NOMEMORY ER      DUP      MAP
                        : NOOMVS  NOUPCASE
```

```
=====
|                               Object Resolution Warnings                    | 2 |
=====
```

```
WARNING EDC4015: Unresolved references are detected:
CEESTART @@TRGLOR CEESG003
```

```
=====
|                               File Map                                       | 3 |
=====
```

```
*ORIGIN  FILE ID  FILE NAME
      P    00001  DD:SYSIN
      IN   00002  *** DESCRIPTORS ***

*ORIGIN:  P=primary input      PI=primary INCLUDE  SI=secondary INCLUDE
          A=automatic call     R=RENAME card      L=C Library
          IN=internal
```

```
=====
|                               Writable Static Map                             | 4 |
=====
```

```
OFFSET  LENGTH  FILE ID  INPUT NAME
      0         4   00001  this_int_is_in_writable_static
      8        10   00002  <year>
```

```
=====
|                               Load Module Map                               | 5 |
=====
```

```
MODULE ID  MODULE NAME
    00001  EXPONLY
```

```
=====
|                               Import Symbol Map                             | 6 |
=====
```

```
*TYPE  FILE ID  MODULE ID  NAME
      D    00001    00001  year

*TYPE:  D=imported data  C=imported code
```

Figure 11. Prelinker Map (Part 1 of 2)

Prelinking Applications

```
=====
|                               Export Symbol Map                               | 7 |
=====

*TYPE   FILE ID  NAME
C       00001   get_year
C       00001   next_year
D       00001   this_int_is_in_writable_static
C       00001   Name_Collision_In_First_Eight
C       00001   Name_Collision_In_First8

*TYPE:  D=exported data  C=exported code

=====
|                               ESD Map of Defined and Long Names               | 8 |
=====

          OUTPUT
*REASON  FILE ID  ESD NAME  INPUT NAME
P                CEESTART  CEESTART
D       00001   @ST0002  Name_Collision_In_First_Eight
D       00001   @ST0001  Name_Collision_In_First8
D       00001   NEXT@YEA  next_year
D       00001   GET@YEAR  get_year
D       00001   THIS@INT  this_int_not_in_writable_static
P                @@TRGLOR  @@TRGLOR
P                CEESG003  CEESG003

*REASON: P=#pragma or reserved      S=matches short name      R=RENAME card
          L=C Library                 U=UPCASE option          D=Default

=====  E N D   O F   P R E - L I N K A G E   M A P   =====
```

Figure 11. Prelinker Map (Part 2 of 2)

The numbers in the following text correspond to the numbers shown in the map.

1 Heading

The heading is always generated and contains the product number, the library release number, the library version number, the date and the time the prelink step began, followed by a list of the prelinker options in effect for the step.

2 Object Resolution Warnings

This section is generated if objects remained undefined at the end of the prelink step or if duplicate objects were detected during the step. The names of the applicable objects are listed.

3 File Map

This section lists the object modules that were included in input. An object module consisting only of RENAME control statements, for example, is *not* shown. Also provided in this section are source origin (*ORIGIN), name (FILE NAME), and identifier (FILE ID) information. *ORIGIN indicates that the object module came from primary input because of:

- An INCLUDE control statement in primary or secondary input.
- A RENAME control statement.
- The resolution of L-name library references.
- The object module was internal and self-generated by the prelink step.

The FILE ID can be found in other sections and is used as a cross-reference to the object module.

The FILE NAME can be either the data set name and, if applicable, the member name, or the dname and, if applicable, the member name.

If you are prelinking an application that imports variables or functions from a DLL, the variable descriptors and function descriptors are defined in a file called `*** DESCRIPTORS ***`. This file has an origin of internal.

4 Writable Static Map

This section is generated if an object module was encountered that contains defined static external data. This area also contains variable descriptors for any imported variables and, if required, function descriptors. This section lists the names of such objects, their lengths, their relative offset within the writable static area, and a FILE ID for the file containing the object's definition.

Imported variables and DLL-referenced functions have angular brackets (<>) around their names in this section.

5 Load Module Map

This section is generated if the application imports symbols from other load modules. This section lists the names of the load modules.

6 Import Symbol Map

This section lists the symbols that are imported from other load modules. These otherwise unresolved DLL references are resolved through IMPORT control statements. It describes the type of symbol, that is, D (variable) or C (function). It also lists the file ID of the object module containing the corresponding IMPORT control statements, the module ID of the load module on that control statement, and the symbol name.

A DLL application would generate this section.

7 Export Symbol Map

This section lists the symbols generated by an object module that exports symbols. It describes the type of symbol, that is, D (variable) or C (function). It also lists the file ID of the object where the symbol is defined and the symbol name. Only externally defined data objects in writable static or externally defined functions can be exported.

Code that is compiled with the C, or COBOL EXPORTALL compiler option or C/C++ code containing the #pragma export directive generates an object module that exports symbols.

8 ESD Map of Defined and Longnames

This section lists the names of external symbols that are not in writable static. It also shows a mapping of input L-names to output S-names.

If the object is defined, the FILE ID indicates the file that contains the definition. Otherwise, this field is left blank. For any name, the input name and output S-name are listed. If the input name is an L-name, the rule used to map the L-name to the S-name is applied. If the name is not an L-name, this field is left blank.

Control Statement Processing

The only control statements processed by the prelinker are IMPORT, INCLUDE, LIBRARY, and RENAME. The remaining control statements are left unchanged until the link-edit step.

The control statements can be placed in the input stream or stored in a CMS file.

Note: If you cannot fit all of the information on one control statement, you can use one or more continuations. The L-name, for example, can be split across more than one statement. Continuations are enabled by placing a nonblank character in column 72 of the statement that is to be continued. They must begin in column 16 of the next statement.

IMPORT Control Statement

The prelinker processes IMPORT statements, but does not pass them on to the link step. The IMPORT control statement, which is supported only under OS/390, has the following syntax:

Syntax

```

▶▶—IMPORT—CODE—dll-name—function—
          |
          |—DATA—dll-name—variable—▶▶
    
```

dll-name

The name or alias of the load module for the DLL. The maximum length of an alias is 8 characters. The *dll-name* can also be an HFS name; it must be enclosed in apostrophes if special characters, such as apostrophes or blanks, appear in the *dll-name*.

variable

An exported variable name; it is a mixed-case longname. Use a nonblank character in column 72 of the card to indicate a continuation and begin the next line in column 16.

function

An exported function name; it is a mixed-case longname. Use a nonblank character in column 72 of the card to indicate a continuation and begin the next line in column 16.

INCLUDE Control Statement

The INCLUDE control statement has the following syntax:

Syntax

```

▶▶—INCLUDE—filename—
          |
          |—ddname—(—member—)▶▶
    
```

filename

The name of the file to be included.

ddname

A ddname associated with a file to be included.

member

The member of the DD to be included.

The prelinker processes INCLUDE statements like the DFSMS linkage editor does with the following exceptions:

- INCLUDEs of identical member names are not allowed.
- INCLUDEs of both a ddname and a member from the same ddname are not allowed. The prelinker ignores the second INCLUDE.

LIBRARY Control Statement

The LIBRARY control statement has the following syntax:

Syntax

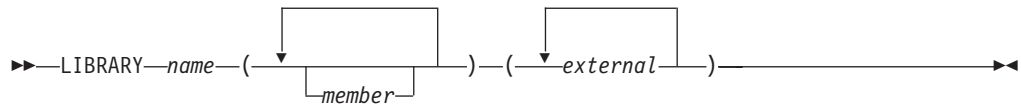

name

The ddname defining a loadlib. The ddname can point to an archive file in the BFS if the OE option is specified, or a CMS loadlib.

member

The name or alias of a member of the specified library. Because both S-names and L-names can be specified, case distinction is significant.

external

An external reference that could be unresolved after primary input processing. This external reference will not be resolved by an automatic library call. Because both S-names and L-names can be specified, case distinction is significant.

The LIBRARY control statement is removed and not placed in the prelinker output object module; the system linkage editor does not see the LIBRARY control statement.

RENAME Control Statement

The RENAME control statement has the following syntax:

Syntax

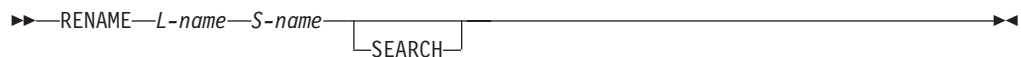

L-name

The name of the input L-name to be renamed on output. All occurrences of this L-name are renamed.

S-name

The name of the output S-name to which the L-name will be changed. This name can be at most 8 characters and case is respected.

SEARCH

An optional parameter specifying that if the S-name is undefined, the prelinker searches by an automatic library call for the definition of the S-name.

Prelinking Applications

The RENAME control statement is processed by the prelinker and can be used for several purposes:

- To explicitly override the default name given to an L-name when an L-name is mapped to an S-name.

You can explicitly control the names presented to the system linkage editor so that external variable and function names are consistent from one linkage editor run to the next. This consistency makes it easier to recognize control section and label names that appear in system dumps and linkage editor listings. Another mapping rule (described in “Mapping L-Names to S-Names”) can provide the suitable name, but if you need to replace the linkage editor control section, you need to maintain consistent names.

- To explicitly bind an L-name to an S-name. This binding might be necessary when communicating with objects from other language and assembler processors, because these processors generate only S-names.
- A RENAME control statement cannot be used to rename a writable static object because its name is not contained in the output from the prelinker.

RENAME control statements can be placed before, between, or after other control statements or object modules. An object module can contain only RENAME statements. Also, RENAME statements can be placed in input that is included because of other RENAME statements.

Usage Notes

- A RENAME statement is ignored if the L-name is not encountered in the input.
- A RENAME statement for an L-name is valid provided **all** of the following are true:
 - The L-name was not already mapped because of a rule that preceded the RENAME statement rule in the hierarchy described in “Mapping L-Names to S-Names.”
 - The L-name was not already mapped because of a previous valid RENAME statement for the L-name.
 - The S-name is not itself an L-name. This rule holds true even if the S-name has its own RENAME statement.
 - A previous valid RENAME statement did not rename another L-name to the same S-name.
 - Either the L-name or the S-name is not defined. Either the L-name or the S-name can be defined, but not both. This rule holds true even if the S-name has its own RENAME statement.

Mapping L-Names to S-Names

The output object module of the prelinker can be used as input to a system linkage editor.

Because system linkage editors accept only S-names, the Language Environment prelinker maps L-names to S-names on output. S-names are not changed. L-names can be up to 160 (COBOL for OS/390 & VM and COBOL for MVS & VM), 255 (z/OS XL C/C++), or 1024 (z/OS XL C++) characters in length; truncation of the L-names to the 8-character S-name limit is therefore not sufficient because collisions can occur.

The Language Environment prelinker maps a given L-name to a S-name according to the following hierarchy:

1. **C/C++ only:** If any occurrence of the L-name is a reserved run-time name, or was caused by a `#pragma map` or `#pragma CSECT` directive, then that same name is chosen for all occurrences of the name. This name must not be changed, even if a `RENAME` control statement for the name exists. For information on the `RENAME` control statement, see “`RENAME` Control Statement” on page 101.
2. If the L-name was found to have a corresponding S-name, the same name is chosen. For example, `DOTOTALS` is coded in both a C and assembler program. This name must not be changed, even if a `RENAME` statement for the name exists. This rule binds the L-name to its S-name.
3. If a valid `RENAME` statement for the L-name is present, the S-name specified on the `RENAME` statement is chosen.
4. If the name corresponds to a Language Environment function or library object for which you did not supply a replacement, the name chosen is the truncated, uppercased version of the L-name library name (with `_` mapped to `@`).

The S-name is not chosen, if either:

- A valid `RENAME` statement renames another L-name to this S-name. For example, the `RENAME` statement `RENAME mybigname PRINTF` would make the library `printf()` function unavailable if `mybigname` is found in input.
- Another L-name is found to have the same name as the S-name. For example, explicitly coding and referencing `SPRINTF` in the C source program would make the library `sprintf()` function unavailable.

Avoid such practices to ensure that the appropriate Language Environment function is chosen.

5. If the `UPCASE` option is specified, names that are 8 characters or fewer are changed to uppercase (with `_` mapped to `@`). Names that begin with `IBM` or `CEE` will be changed to `IB$`, and `CE$`, respectively. Because of this rule, two different names can map to the same name. You should therefore use the `UPCASE` option carefully. A warning message is issued if a collision is found, but the names are still mapped.
6. If none of the above rules apply, a default mapping is performed. This mapping is the same as the one the compiler option `NOLONGNAME` uses for external names, taking collisions into account. That is, the name is truncated to 8 characters and changed to uppercase (with `_` mapped to `@`). Names that begin with `IBM` or `CEE` will be changed to `IB$` and `CE$`, respectively. If this name is the same as the original name, it is always chosen. This name is also chosen if a name collision does not occur. A name collision occurs if either
 - The S-name has already been seen in **any** input, that is, the name is not new.
 - After applying this default mapping, the same name is generated for at least two, previously unmapped, names.

If a collision occurs, a unique name is generated for the output name. For example, the name `@ST00033` is manufactured.

C++: A program that is compiled with the `NOLONGNAME` compiler option and link-edited, except for collisions, library renames, and user renames, presents the linkage editor with the same names as when the program is compiled with the `LONGNAME` option and processed by the prelinker.

Starting the Prelinker

Use the `CPLINK EXEC` to start the prelinker. The syntax for the `CPLINK EXEC` is:

Prelinking Applications

Syntax

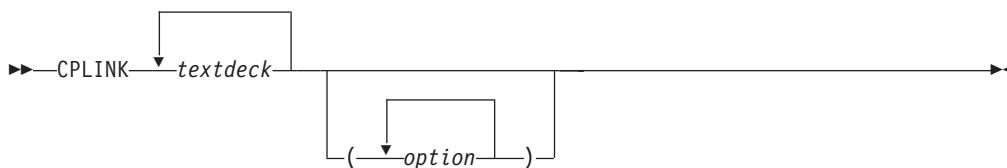

textdeck

The file name of an input file to the prelinker. You can specify more than one file as input to the CPLINK EXEC. Each input file must be a COBOL object module or a C object module with the file type TEXT (that is, a program compiled with the RENT option or a compiled program with no writable static). If you previously used the z/VM GLOBAL TXTLIB command, you can specify the name of a TXTLIB member as the file name. The first text deck must contain the function's main, or the fetchable routine.

options

An option or list of options to be passed to the prelinker. The prelinker is started with CMOD EXEC if you specify options for the prelinker by using the option CPLINK(options) or if you have specified the LONGNAME or RENT compiler option. See "Prelinker Options" for a list of prelink options.

Output from the prelinker is placed in the file CPOBJ TEXT A. The prelinker map is placed in the file CPOBJ RMAP A.

Examples

The following example prelinks the text decks ROUTER, SENDMSG and REPLYMSG and places the output text deck in CPOBJ TEXT A. A writable static map is generated and placed in CPOBJ RMAP A. Unresolved references are not processed.

```
CPLINK ROUTER SENDMSG REPLYMSG (NOLIBE
```

The following example prelinks the text decks SORT, MERGE and READFILE and displays only warning and error messages at the terminal. A prelink listing is not generated. All external references are resolved from ACCNT TXTLIB and a disk search.

```
GLOBAL TXTLIB ACCNT  
CPLINK SORT MERGE READFILE (NOMAP NOER NODUP LIBE AUTO
```

To use CMOD to invoke the prelinker with the prelink options AUTO and the CMOD option AUTO specify:

```
CMOD PGM (CPLINK(AUTO) AUTO
```

The following example shows you how to quickly link and prelink using CMOD while keeping the CPOBJ TEXT text deck generated by the prelinker, without generating either a LOAD or a CPLINK MAP.

```
CMOD MYMAIN MYPROCS ( CPLINK(KEEP) NOMAP
```

Prelinker Options

The following table describes the Language Environment prelinker options.

Table 30. Prelinker Options

Option	Description
<u>AUTO</u> NOAUTO	AUTO specifies that the prelinker should try to resolve unresolved short name references by searching all virtual disks for TEXT files of the same name. Use NOAUTO when using the CPOBJ file as input to the LINKLOAD EXEC.
<u>DLLNAME</u>(dll-name)	If you do not specify DLLNAME, the DLL name is set to the name that appeared on the last NAME control statement that was processed. If there are no NAME control statements, and the output object module of the prelinker is a PDS member, the DLL name is set to the name of that member. Otherwise the DLL name is set to the value TEMPNAME, and the prelinker issues a warning.
<u>DUP</u> NODUP	DUP specifies that if duplicate symbols are detected, the symbol names should be directed to stdout, and the return code minimally set to a warning level of 4. NODUP does not affect the return code setting when duplicates are detected.
<u>ER</u> NOER	ER specifies that if there are unresolved references, a message and list of unresolved symbols are written to the console. For unresolved references, the return code is minimally set to warning level 4. For unresolved writable static references, the return code is minimally set to error level 8. NOER specifies that a list of unresolved symbols is not written to the console. For unresolved references, the return code is unaffected. For unresolved writable static references, the return code is minimally set to warning level 4.
<u>LIBE</u> NOLIBE	LIBE specifies that the prelinker should search TEXT libraries (specified previously with the z/VM GLOBAL command) to resolve unresolved references.
<u>MAP</u> NOMAP	The MAP option specifies that the prelinker should generate a prelink listing. See “Language Environment Prelinker Map” on page 96 for a description of the map.
<u>MEMORY</u> <u>NOMEMORY</u>	The MEMORY option specifies that the prelinker will buffer (retain in storage), for the duration of the prelink step, those object modules that are read and processed. The MEMORY option is used to increase prelinker speed. To use this option, however, additional memory may be required. If you use this option and the prelink fails due to a storage error, you must increase your storage size or use the prelinker without the MEMORY option.
<u>NCAL</u> <u>NONCAL</u>	The NCAL option specifies that the prelinker should not use automatic library call to resolve unresolved references. NONCAL specifies that an automatic library call is performed, which applies to a library of user routines. The data set must be partitioned and must contain object modules. An automatic library call cannot apply to a library containing load modules.
<u>OE</u> <u>NOOE</u>	The OE option causes the prelinker to change its processing of INCLUDE and LIBRARY control statements. OE causes the prelinker to accept HFS or BFS files and data set names on INCLUDE and LIBRARY statements.
<u>UPCASE</u> <u>NOUPCASE</u>	The UPCASE option enforces the uppercase mapping of those L-names that are 8 characters or fewer and have not been explicitly mapped by another mechanism. These L-names will be uppercased (with _ mapped to @), and names that begin with IBM or CEE will be changed to IB\$ and CE\$, respectively. The UPCASE option is useful when calling routines written in languages other than C. For example, PL/I and assembler each uppercases all of its external names. So, if the names are coded in lowercase in the C program and the LONGNAME option is used, the names will not match by default. The UPCASE option can be used to enforce this matching. The RENAME control statement can also be used for this purpose.

Prelinking Applications

Style 1:

```
parm      = (int) __R1;  (restricted to integer types)
```

Style 2:

```
parm_ptr  = (float *) __R1
parm      = * ((float *) __R1);
```

Style 3:

```
parm0_ptr = (float *) __osplist[0];
parm0     = * ((float *) __osplist[0]);
```

Figure 14. Examples of Casting and Dereferencing

C PLIST and EXECOPS Interactions

You can use C `#pragma runopts` to specify to the C compiler a list of options to be used at run time. Two of the options of `#pragma runopts` affect the format of the argument list passed to the application on initialization: EXECOPS and PLIST.

EXECOPS allows you to specify run-time options on the command line at application invocation. NOEXECOPS indicates that run-time options cannot be so specified. When the EXECOPS run-time option is specified under MVS, Language Environment alters the MVS parameter list format: Language Environment removes any run-time options that are present.

PLIST indicates in what form the invoked routine should expect the argument list. You can specify PLIST with the following values under Language Environment:

- HOST** The argument list is assumed to be a character string. The string is located differently under various systems as follows:
- If invoked by OSRUN, Language Environment uses the string presented in an MVS-like format located by the pointer held in register 1.
 - If not invoked by OSRUN, Language Environment uses the CMS extended parameter list.
- OS** The inbound parameter list is assumed to be in an MVS linkage format in which register 1 points to a parameter address list. No run-time options are available. Register 1 is not interrogated by Language Environment.

The PLIST(HOST) setting permits portability of source code between MVS and z/VM. PLIST(HOST) allows the object to execute under z/VM (using either the MVS-format argument list for OSRUN or the extended argument list), under MVS (assuming a halfword-prefixed string), or under TSO (using the CPPL or the MVS-format parameter list). Specify PLIST(HOST) to default to the argument list format for the operating system under which your application is running.

Although Language Environment supports the MVS, CMS, IMS, and TSO suboptions of PLIST for compatibility, use of PLIST(HOST) is recommended. There are some exceptions to this guideline:

Preinitialization

In the previous C interface to preinitialization, it was necessary to specify PLIST(MVS) in order to flag preinitialized routines. PLIST(MVS) is therefore still supported for compatibility.

Operating System and Subsystem Parameter Lists

The EXECOPS, NOEXECOPS, and PLIST options can alter the format of the argument list passed to your application, depending on the combination of options specified. The setting of EXECOPS determines whether Language Environment looks for run-time parameters in the inbound parameter list. The effects of the interactions of these options under the various operating systems and subsystems are summarized in Table 31:

Table 31. Interactions of C PLIST and EXECOPS (#pragma runopts)

Method of Invocation	PLIST Suboption	EXECOPS (default)	argc/argv	__R1/ __osplist and PCBs
LKED, OSRUN Call module on command line passing <run-time options> / <user args>	HOST	Yes. <run-time options> honored	argc = number of tokenized user args. argv[0...argc-1] = tokenized user args	
LKED, OSRUN Call module on command line passing <run-time options> / <user args>	HOST	No. <run-time options> ignored	argc = number of tokenized user args in both run-time options and user args argv[0...argc-1] = tokenized args in both run-time options and user args	
Assembler calls C module with pre-Language Environment preinitialization PLIST with run-time options specified in the PLIST	MVS	Yes. <run-time options> honored	argc/argv = <argc,argv> structure specified for pre-Language Environment preinitialization	
Assembler calls C module with pre-Language Environment preinitialization PLIST with run-time options specified in the PLIST	MVS	No. <run-time options> ignored	argc/argv = <argc,argv> structure specified for pre-Language Environment preinitialization	

Parameter Passing Considerations with XPLINK C and C++

C and C++ code compiled with the XPLINK option builds parameter lists using the same logical format. However, the compiler may optimize some of the parameters into registers. For more information, see *z/OS Language Environment Vendor Interfaces*.

COBOL Parameter Passing Considerations

COBOL users cannot explicitly set the PLIST and EXECOPS run-time options for an enclave containing a COBOL main program. When COBOL is the main program, Language Environment sets the argument list passed to the application on initialization as follows:

- If the COBOL main is invoked by OSRUN, run-time options are removed. An adjusted string (without run-time options) is passed to the application.
- If the COBOL main is not invoked by OSRUN, register 0 points to a CMS extended parameter list. Run-time options are removed and repackaged as a halfword-prefixed string.
- If the COBOL main is invoked from an assembler routine using standard assembler linkage conventions, then register 1 and the argument list are passed without change.

PL/I Main Procedure Parameter Passing Considerations

The format of the parameter list passed to a PL/I main procedure from the operating system is controlled by the SYSTEM compiler option and also by options on the main PROCEDURE statement.

The SYSTEM compiler option specifies the format used to pass parameters to the PL/I main procedure, and indicates the host system under which the program runs: MVS, CMS (or CMSTPL for compatibility), CICS, IMS, or TSO. The SYSTEM option allows a program compiled under one system to run under another.

The NOEXECOPS procedure option indicates that run-time options are not present in the operating system parameter list. The NOEXECOPS option can be explicitly specified or implicitly defaulted. Otherwise, it is assumed that run-time options might be present in the operating system parameter list. If present, these run-time options are removed by run-time initialization before the PL/I main procedure gains control.

In order for run-time options to be passed in the operating system parameter list for SYSTEM(MVS) or SYSTEM(CMS), the PL/I main procedure must receive no parameters or receive a single parameter that is a varying character string. If this is not the case, NOEXECOPS is always defaulted.

The OPTIONS(BYVALUE) or OPTIONS(BYADDR) procedure options indicate if the main procedure parameters are passed directly or indirectly. If SYSTEM(IMS) or SYSTEM(CICS) is specified for a PL/I for MVS & VM main procedure, the OPTIONS(BYVALUE) procedure option is defaulted at compilation time, OPTIONS(BYADDR) is not permitted. When SYSTEM(CICS) and SYSTEM(IMS) is specified, Language Environment remaps the parameters to match the OPTIONS attribute BYADDR or BYVALUE of the main procedure. See *z/OS: Language Environment Programming Guide* for additional information about Language Environment parameter passing.

The following tables describe the interaction of the PL/I SYSTEM and NOEXECOPS options. Their effect is described in terms of the parameters that are coded on the MAIN procedure statement and also the incoming system, subsystem, or assembler parameter list as initially received by Language Environment.

Operating System and Subsystem Parameter Lists

Table 32. Interactions of SYSTEM and NOEXECOPS under z/VM

SYSTEM Setting	No Run-Time Options (NOEXECOPS)	Run-Time Options Can Be Present
SYSTEM(CMS)	<p>If the main procedure parameter is a single varying character string, a CMS extended parameter list is assumed and repackaged so the main procedure receives a halfword-prefixed string, without looking for run-time options.</p> <p>Otherwise, the parameter list is passed without change.</p>	<p>If the main procedure parameter is a single varying character string, a CMS extended parameter list is assumed and repackaged so the main procedure receives a halfword-prefixed string. Any run-time options are removed from the string, and the (potentially) altered string is passed.</p> <p>Otherwise, the parameter list is passed without change.</p>
SYSTEM(MVS)	<p>If the main procedure parameter is a single varying character string, an MVS parameter list is assumed and repackaged so the main procedure receives a halfword-prefixed string. The entire string is passed to the main procedure without change.</p> <p>Otherwise, the parameter list is passed without change.</p>	<p>If the main procedure parameter is a single varying character string, an MVS parameter list is assumed and repackaged so the main procedure receives a halfword-prefixed string. Any run-time options are removed from the string, and the (potentially) altered string is passed.</p> <p>Otherwise, the parameter list is passed without change.</p>

Note: When Language Environment is directed to use the CMS extended parameter list, and Language Environment determines that R0 is **not** pointing to a CMS extended parameter list, Language Environment issues user ABEND 4093, reason code X'60' (96).

Appendix C. Object Library Utility

The *Object Library Utility* is used to update libraries of object modules. A library is a text library (TXTLIB) with object modules as members.

Object libraries provide for convenient packaging of object modules. With the Object Library Utility, a library can contain object modules with L-names, object modules with S-names, and object modules with writable static data. The Object Library Utility is used to create information, such as which members contain defined L-names, S-names, or writable static data. This information is stored in a special member of the library that will be referred to as the *Object Library Utility directory*.

Notes:

1. The TXTLIB command also creates object libraries but it does not allow you to include external names greater than 8 characters long. The syntax for the Object Library Utility is similar to the TXTLIB command.
2. Because C generates private code if you do not include a `#pragma csect(code)` directive in your source or if you do not create a NAME control statement using the ALIAS compiler option, you should use the FILENAME option on either the TXTLIB or C370LIB commands.

Commands to add object modules to a library, to delete object modules from a library, or to build the Object Library Utility directory for a library are available. Use the DIR command to build the Object Library Utility directory for a library of object modules. Use the MAP command to list the contents of the Object Library Utility directory.

Creating an Object Library

Use the C370LIB EXEC to create an object library:

Syntax

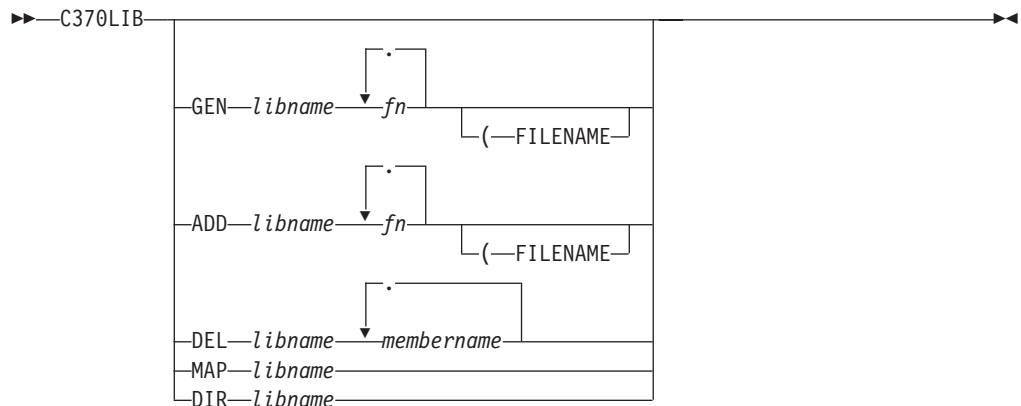

GEN

Creates a TXTLIB on your A-disk. If a TXTLIB with the same name already exists, it is replaced.

libname

Specifies the file name of a file of type TXTLIB that is to be created or listed, or from which members are to be added or deleted, or for which a Object Library Utility directory is to be built.

Object Library Utility

fn Specifies the name of file of type TEXT that you want to add to a TXTLIB.

FILENAME

Indicates that all the file names specified (*fn1*) should be used as the member names for their respective entries in the TXTLIB file.

ADD

Adds TEXT files as members to an existing TXTLIB on a read/write disk. No checking is done for duplicate names, entry points, or CSECTs.

DEL

Deletes members from a TXTLIB on a read/write disk and compresses the TXTLIB to remove unused space. If more than one member exists with the same name, only the first entry is deleted.

membername

Specifies the name of a TXTLIB member that you want to delete.

MAP

Lists the names (entry points) of TXTLIB members. MAP produces a file, libname MAP, on your A-disk. For more information about the map, see *XL C/C++ for z/VM: User's Guide*.

DIR

Builds the TXTLIB Object Library Utility directory. The Object Library Utility directory contains the names (entry points) of library members. The DIR function is only necessary if TEXT files were previously added or deleted from the TXTLIB without using C370LIB.

C370LIB must be used to update a TXTLIB with TEXT files produced by compiling C programs with the LONGNAME option. The z/VM TXTLIB command cannot be used to do this directly and an error can result if this is attempted.

When a TEXT file is added to a library, its member name is selected according to the following hierarchy:

1. From the file name, if the FILENAME option is specified
2. From the NAME control statement, if present, in the TEXT file
3. From the file name

The CMS TXTLIB command's GEN, ADD, and DEL functions are used as part of the C370LIB GEN, ADD, and DEL functions. Thus, any TXTLIB restrictions apply also to C370LIB unless otherwise stated. Members must be deleted by their member name. Any attempt to delete using a name other than the member name results in a warning message.

In the following example, the C programs SUB1 C and SUB2 C are compiled for L-names. The function library SUBLIB TXTLIB A is created with SUB1 TEXT using the GEN command of C370LIB; the Object Library Utility SUB2 TEXT is added to the library using the ADD command.

```
CC SUB1 (LO
CC SUB2 (LO
C370LIB GEN SUBLIB SUB1
C370LIB ADD SUBLIB SUB2
```

The LINKLOAD EXEC

The following IBM-supplied EXEC generates a fetchable member of a z/VM load library:

Syntax

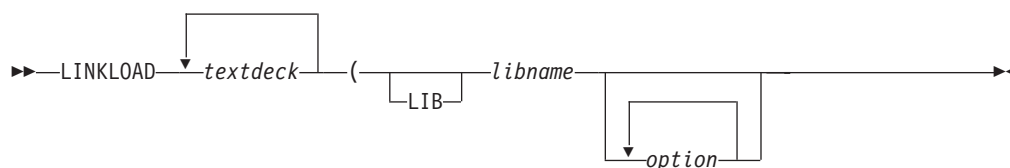
*textdeck*

Specifies the name of the input text decks. The file type of the object modules must be TEXT, and the source programs must have contained a #pragma linkage (name, FETCHABLE) preprocessor directive. Note that you do not specify the file type or the file mode when using the LINKLOAD EXEC.

libname

Specifies the name of the library where the load member is to be stored. The library name parameter must be specified, but if it is the first parameter, the keyword LIB is optional.

option

Specifies any options you want to apply when you are generating the fetchable load library member:

- CPLINK** Allows you to pass options to the prelinker. The format of the CPLINK options is *CPLINK (prelinker options)*. CPLINK is called if it is required by the text decks, or if a CPLINK option is given. For more information see Appendix A, "Prelinking an Application," on page 93.
- MBR** Indicates that the next argument, *memname*, is the name of the member within the load library that is to be generated. If you do not specify a member name, the name of the text deck containing the fetchable code is used.
- LKED** Indicates that the options following it are to be passed to LKED. If you do not use this option, default options are used. The format of the LKED keyword is *LKED (link-edit options)*. For more information on the LKED command, see "Link-Editing with the LKED Command" on page 14

Only one of the following options can be specified on a given invocation of LINKLOAD:

- ADD** Indicates that the load member generated by the LINKLOAD EXEC is to be added to the load library. If a member by the same name already exists, the new member is not added.
- REPLACE** Indicates that the load member generated by the LINKLOAD EXEC is to replace the member having the same name in the load library. If a member by the same name does not exist, the new member is added.
- NEW** Indicates that an existing load library of the same name containing only the named member should be created.

Object Library Utility Map

The Object Library Utility produces a listing for a given library when the MAP command is specified. The listing contains information on each member of the library. A representative example is shown in Figure 15.

```

=====
|                                     Object Library Utility Map                                     | 1 |
| C370LIB:5739A03 V4 R4 M00 IBM z/VM                                     2003/02/28 21:19:26 |
|=====

Library Name: TS41949.A.OBJECT                                     2003/02/28 21:19:26

*-----*
* Member Name: ASMSTUFF                                     (D) 2003/02/28 21:19:26 2 *
*                                     569623400 R01 M01 *
*-----*

(S) External Name: CSECT1
(S) External Name: ENTRY1

*-----*
* Member Name: CSTUFF                                     (D) 2003/02/28 21:19:26 2 *
*                                     5694A01 V1 R02 *
*-----*

(L) Function Name: foo
(WL) External Name: this_int_is_in_writable_static_and_its_name_will
                    _wrap_because_it_is_too_long

*-----*
* Member Name: CXXSTUFF                                     (D) 2003/02/28 21:19:26 2 *
*                                     5694A01 V1 R02 *
*-----*

3 User Comment: This is a user comment in CXXSTUFF

4 (L) Function Name: testeh()
  (L) Function Name: f1()
  (L) Function Name: operator++(U&)
  (WL) External Name: i1
  (WL) External Name: i2

===== END OF OBJECT LIBRARY MAP =====

```

Figure 15. Object Library Utility Map

1 Map Heading

The heading contains the product number, the compiler release number, the compiler version number, and the date and time the Object Library Utility step commenced. The name of the library immediately follows the heading. To the right of the name of the library is the start time of the last Object Library Utility step that updated the Object Library Utility directory.

2 Member Heading

The name of the object module member is immediately followed by the ID of the processor that produced the object module. The processor ID is based on the presence of an END record in the object module having the processor information in the appropriate format. If this information is not present, the Processor ID field is not listed.

The Timestamp field is presented in *yy/mm/dd* format. The meaning of the timestamp is enclosed in parentheses. That is, the Object Library Utility retains a timestamp for each member and selects the time according to the following hierarchy:

- (P) Indicates that the timestamp is extracted from the object module from the date form of `#pragma` comment or from the timestamp form of `#pragma` comment, whichever comes first.
- (D) Indicates that the timestamp is based on the time that the Object Library Utility DIR command was last issued.
- (F) Indicates that the timestamp is the date of the object module file at the time the ADD or GEN command was issued for the member. This is applicable to z/VM only.
- (T) Indicates that the timestamp is the time that the ADD command was issued for the member. This is applicable to MVS only.

3 User Comments

The user form of comments generated by `#pragma` comment is displayed. These comments are extracted from the END record. It is possible to manually add such comments on multiple END records and have them displayed in the listing. For more information on the END record, see *z/OS XL C/C++ Language Reference*.

4 Symbol Information

Immediately following the Member Heading (and user comments, if any) is a list of the defined objects contained within that member. Each symbol is prefixed by Type information enclosed in parentheses and either External Name or Function Name. Function Name appears provided the object module was compiled with the LONGNAME option and the symbol is the name of a defined external function. In all other cases External Name is displayed. The Type field gives additional information on each symbol. That is:

- 'L' Indicates that the name is an L-name.
- 'S' Indicates that the name is an S-name.
- 'W' Indicates that this is a writable static object. If no 'W' is present, then this is not a writable static object.
- 'WL' Indicates that this is both an L-name and in writable static.

Object Library Utility

Appendix D. Using the Systems Programming Environment

Note: This section applies to C applications only.

As a C routine executes, facilities from the Language Environment common library are invoked to set up the execution environment in order to handle termination activities and provide storage management, error handling, run-time options parsing, ILC, and debugging support. In addition, the C library functions are in the Language Environment common library.

For situations in which not all of these services are needed, the system programming facilities of C can provide a limited environment.

System programming facilities allow you to run applications without using the Language Environment common library, or with just the C library functions, and to:

- Develop C applications that do not require the Language Environment common library on the machines on which they run.
- Develop applications featuring:
 - A persistent C environment, in which a C environment is created once and used repeatedly for C function execution from any language.
 - Co-routines that use a two-stack model, as in client-server style applications. In this style, the user application calls on the applications server to perform services independently of the user and then return to the user.

For more information on the system programming facilities of C, see *z/OS XL C/C++ Programming Guide*.

This chapter discusses how to build these applications once you have compiled them with the C compiler. Note that you must compile these programs with the NOSTART option.

Building Freestanding Applications

Freestanding applications need to be linked with specific alternate initialization routines. This is accomplished differently depending on which operating system you compiled your application under.

To explicitly include an alternative initialization routine under z/VM, include the TEXT file for the alternate entry point **first** in the LOAD commands. To include the alternate initialization routines described in this chapter, you must include SCEESPC in the GLOBAL TXTLIB list. For example, the commands in Figure 16 can be used to specify EDCXSTRT as an alternate initialization routine.

```
LOAD EDCXSTRT main-function (RESET EDCXSTRT ...  
GENMOD module-name (FROM EDCXSTRT
```

Figure 16. Specifying Alternate Initialization at Link-Edit

Building Freestanding Applications

When building freestanding applications under z/VM, SCEESPC TXTLIB must be made available (by the GLOBAL command) when issuing LOAD or INCLUDE commands. In addition to making SCEESPC TXTLIB available, you must specify NOSTART compiler option when compiling the file that contains the main function. This TXTLIB is not required at execution time.

Systems Programming Environment

The routines to support this function (EDCXSTRT and EDCXSTRL) are CEESTART replacements in your module. Therefore, the appropriate EDCXSTR n TEXT file must be explicitly included first in the module.

A simple freestanding routine that does not require the Language Environment common library is shown in Figure 17. An example that requires the use of the Language Environment prelinker is shown in Figure 19.

```
int main() {
    return 54321;
}
```

Figure 17. Simple Freestanding z/VM Routine

The z/VM commands required to build and run this routine are shown in Figure 18.

```
GLOBAL LOADLIB SCEERUN
CC RET54321 (NOSTART
GLOBAL TXTLIB SCEESPC
LOAD EDCXSTRT RET54321 (RESET EDCXSTRT
GENMOD RET54321 (FROM EDCXSTRT
RET54321
```

Figure 18. Building a Freestanding z/VM Routine

Special Considerations for Reentrant Modules

A simple freestanding routine that does not require the Language Environment common library is shown in Figure 19. This routine uses the `exit()` library function which, like `sprintf()`, is available to freestanding routines without requiring the Language Environment common library. This routine is not naturally reentrant, but the resulting load module is reentrant.

```
#include <stdlib.h>

int main() {
    static int i[5]={0,1,2,3,4};
    exit(4320+i[1]);
}
```

Figure 19. Simple Reentrant Freestanding z/VM Routine

The commands required to build this routine are shown in Figure 20. The bracketed numbers in the figure refer to the comments that follow.

```
CC RETS4321 (NOSTART RENT ...
GLOBAL TXTLIB SCEESPC SCEELKED CMSLIB
[20-1]
CPLINK EDCXSTRT RETS4321 EDCRCINT EDCXEXIT (MAP
[20-2]
GLOBAL TXTLIB
[20-3]
LOAD CPOBJ (MAP RESET EDCXSTRT
[20-4]
GENMOD RETS4321 (FROM EDCXSTRT
```

Figure 20. Building a Reentrant Freestanding VM Routine

Notes

- [20-1] The TXTLIB CMSLIB is needed because CPLINK is a C program. The TXTLIB SCEESPC and SCEELKED are used to resolve external references.

[20-2] The alternate initialization routine (EDCXSTRT in this example) must be included explicitly in the module. This should be the first CSECT in the module.

The routine EDCRCINT must be explicitly included in the module because the RENT compiler option is used. No error is detected at load time if this routine is not explicitly included. At run time, abend 2106, reason code 7205, results if EDCRCINT is required but not included.

EDCXEXIT must be explicitly included if the `exit()` function is used in the application.

[20-3] No TXTLIB is required for further processing or execution of this module because no C library functions are needed.

[20-4] EDCXSTRT must be specified as the module entry point.

Building System Exit Routines

There are no special considerations for building system exit routines. These routines can be linked with their callers or dynamically loaded and invoked. SCEESPC TXTLIB must be available at link-edit. If C library functions are required by the exit routines, the libraries SCEELKED must also be made available **after** SCEESPC. If the routines were compiled with OPT(2), the entry point must be explicitly identified using the RESET option on the LOAD command.

Note: You must compile these programs with the NOSTART option.

Building Persistent C Environments

There are no special considerations for building applications that use persistent C environments. The LIBE option of the LOAD command causes the proper object modules to be included from SCEESPC TXTLIB.

If C library functions are required by any routine called in this environment, the library stub routines should also be made available at link time **after** SCEESPC.

Note: You must compile these programs with the NOSTART option.

Building User-Server Environments

To build your server application, follow the rules for building a freestanding application as described in “Building Freestanding Applications” on page 119.

There are no special considerations for building user applications. The LIBE option of the load command causes the proper object modules to be included from SCEESPC TXTLIB. The automatic call facility causes the right routines from the TXTLIB (using the LIBE option) to be included.

Note: You must compile servers with the NOSTART option.

Summary

Table 33. Summary of Types

Type of Application	How It Is Called	Module Entry Point	Data Sets Required at Execution Time	Run-Time Options and Other Considerations
A mainline function that requires no C-specific library functions.	From the command line, or an EXEC or CLIST.	EDCXSTRT must be explicitly included at bind time.	None.	Run-time options are specified by #pragma runopts in the compilation unit for the main() function. The HEAP and STACK options are honored. STACK defaults to above the 16M line.
A mainline function that requires C library functions.	From the command line, or an EXEC or CLIST.	EDCXSTRL must be explicitly included at bind time.	C library functions.	Run-time options are specified by #pragma runopts in the compilation unit for the main() function. The TRAP, HEAP and STACK options are honored, but the stack defaults to above the 16M line.
A mainline function that uses storage pre-allocated by the caller.	From Assembler code.		C library functions are optional; the caller must load these functions and pass their addresses to EDCXSTRX, if required to by the application.	Run-time options are specified by #pragma runopts in the main() function. The TRAP option is honored if C library functions are required.
An exit.	Typically from assembler code, with a structured parameter list.		C library functions, if required.	Run-time options are specified by #pragma runopts in the compile unit for the entry point. The HEAP and STACK options are honored, but the stack defaults to be above the 16M line. The TRAP option is honored if C library functions are required.

Table 33. Summary of Types (continued)

Type of Application	How It Is Called	Module Entry Point	Data Sets Required at Execution Time	Run-Time Options and Other Considerations
<p>A C subroutine called from Assembler language using a pre-established persistent environment.</p>	<p>A handle, the address of the subroutine, and a parameter list are passed to EDCXHOTU.</p>		<p>C library functions are optional, depending on the way the handle was set up.</p>	<p>Run-time options are specified by #pragma runopts in any compile unit. The HEAP and STACK options are honored, but the stack defaults to above the 16M line. The TRAP option is honored if C library functions are called for. The runopts in the first object module in the link-edit that contains runopts prevails, even if this compilation unit is part of the calling application.</p> <p>The environment is established by calling EDCXHOTC or EDCXHOTL (if library functions are required). These functions return a value (the handle), which is used to call functions that use the environment.</p>
<p>A server.</p>	<p>User code includes a stub routine that calls EDCXSRVI. This causes the server to be loaded and control to be passed to its entry point.</p>	<p>EDCXSTRT or EDCXSTRL, depending on whether the server needs C library functions.</p>	<p>C library functions, if required by the server code.</p>	<p>Run-time options are the same as for EDCXSTRL or EDCXSTRT.</p> <p>The author of the server must supply stub routines that call EDCXSRVI and EDCXSRVN to initialize and communicate with the server. These are bound with the user application.</p>
<p>A user of an application server.</p>			<p>The server and C library functions, if required by the server.</p>	<p>The author of the server must supply stub routines which call EDCXSRVI and EDCXSRVN to initialize and communicate with the server.</p>

Notices

This information was developed for products and services offered in the U.S.A.

IBM® may not offer the products, services, or features discussed in this document in other countries. Consult your local IBM representative for information on the products and services currently available in your area. Any reference to an IBM product, program, or service is not intended to state or imply that only that IBM product, program, or service may be used. Any functionally equivalent product, program, or service that does not infringe any IBM intellectual property right may be used instead. However, it is the user's responsibility to evaluate and verify the operation of any non-IBM product, program, or service.

IBM may have patents or pending patent applications covering subject matter described in this document. The furnishing of this document does not give you any license to these patents. You can send license inquiries, in writing, to:

IBM Director of Licensing
IBM Corporation
North Castle Drive
Armonk, NY 10504-1785
USA

For license inquiries regarding double-byte (DBCS) information, contact the IBM Intellectual Property Department in your country or send inquiries, in writing, to:

IBM World Trade Asia Corporation
Licensing
2-31 Roppongi 3-chome, Minato-ku
Tokyo 106, Japan

The following paragraph does not apply to the United Kingdom or any other country where such provisions are inconsistent with local law:

INTERNATIONAL BUSINESS MACHINES CORPORATION PROVIDES THIS PUBLICATION "AS IS" WITHOUT WARRANTY OF ANY KIND, EITHER EXPRESS OR IMPLIED, INCLUDING, BUT NOT LIMITED TO, THE IMPLIED WARRANTIES OF NON-INFRINGEMENT, MERCHANTABILITY OR FITNESS FOR A PARTICULAR PURPOSE. Some states do not allow disclaimer of express or implied warranties in certain transactions, therefore, this statement may not apply to you.

This information could include technical inaccuracies or typographical errors. Changes are periodically made to the information herein; these changes will be incorporated in new editions of the publication. IBM may make improvements and/or changes in the product(s) and/or the program(s) described in this publication at any time without notice.

Any references in this information to non-IBM Web sites are provided for convenience only and do not in any manner serve as an endorsement of those Web sites. The materials at those Web sites are not part of the materials for this IBM product and use of those Web sites is at your own risk.

IBM may use or distribute any of the information you supply in any way it believes appropriate without incurring any obligation to you.

Licensees of this program who wish to have information about it for the purpose of enabling: (i) the exchange of information between independently created programs and other programs (including this one) and (ii) the mutual use of the information which has been exchanged, should contact:

IBM Corporation
Mail Station P300
2455 South Road
Poughkeepsie, NY 12601-5400
USA

Such information may be available, subject to appropriate terms and conditions, including in some cases, payment of a fee.

The licensed program described in this information and all licensed material available for it are provided by IBM under terms of the IBM Customer Agreement, IBM International Program License Agreement, or any equivalent agreement between us.

Any performance data contained herein was determined in a controlled environment. Therefore, the results obtained in other operating environments may vary significantly. Some measurements may have been made on development-level systems and there is no guarantee that these measurements will be the same on generally available systems. Furthermore, some measurement may have been estimated through extrapolation. Actual results may vary. Users of this document should verify the applicable data for their specific environment.

Information concerning non-IBM products was obtained from the suppliers of those products, their published announcements or other publicly available sources. IBM has not tested those products and cannot confirm the accuracy of performance compatibility or any other claims related to non-IBM products. Questions on the capabilities of non-IBM products should be addressed to the suppliers of those products.

All statements regarding IBM's future direction or intent are subject to change without notice, and represent goals and objectives only.

This information contains examples of data and reports used in daily business operations. To illustrate them as completely as possible, the examples include the names of individuals, companies, brands, and products. All of these names are fictitious and any similarity to the names and addresses used by an actual business enterprise is entirely coincidental.

COPYRIGHT LICENSE:

This information contains sample application programs in source language, which illustrates programming techniques on various operating platforms. You may copy, modify, and distribute these sample programs in any form without payment to IBM, for the purposes of developing, using, marketing or distributing application programs conforming to the application programming interface for the operating platform for which the sample programs are written. These examples have not been thoroughly tested under all conditions. IBM, therefore, cannot guarantee or imply reliability, serviceability, or function of these programs. You may copy, modify, and distribute these sample programs in any form without payment to IBM for the purposes of developing, using, marketing, or distributing application programs conforming to IBM's application programming interfaces.

If you are viewing this information softcopy, the photographs and color illustrations may not appear.

Programming Interface Information

This book documents intended Programming Interfaces that allow the customer to write programs to obtain the services of Language Environment in z/VM.

Trademarks

The following terms are trademarks of the IBM Corporation in the United States or other countries or both:

IBM, the IBM logo, and ibm.com are trademarks or registered trademarks of International Business Machines Corp., registered in many jurisdictions worldwide. Other product and service names might be trademarks of IBM or other companies. A current list of IBM trademarks is available on the Web at “Copyright and trademark information” at www.ibm.com/legal/copytrade.shtml

Adobe is a registered trademark of Adobe Systems Incorporated in the United States, and/or other countries.

UNIX is a registered trademark of The Open Group in the United States and other countries.

Linux is a trademark of Linus Torvalds in the United States, other countries, or both.

Other company, product and service names may be trademarks or service marks of others.

Glossary

For a list of z/VM terms and their definitions, see *z/VM: Glossary*.

The z/VM glossary is also available through the online z/VM HELP Facility. For example, to display the definition of the term “dedicated device”, issue the following HELP command:

```
help glossary dedicated device
```

While you are in the glossary help file, you can do additional searches:

- To display the definition of a new term, type a new HELP command on the command line:

```
help glossary newterm
```

This command opens a new help file inside the previous help file. You can repeat this process many times. The status area in the lower right corner of the screen shows how many help files you have open. To close the current file, press the Quit key (PF3/F3). To exit from the HELP Facility, press the Return key (PF4/F4).

- To search for a word, phrase, or character string, type it on the command line and press the Clocate key (PF5/F5). To find other occurrences, press the key multiple times.

The Clocate function searches from the current location to the end of the file. It does not wrap. To search the whole file, press the Top key (PF2/F2) to go to the top of the file before using Clocate.

Bibliography

See the following publications for additional information about z/VM. For abstracts of the z/VM publications, see *z/VM: General Information*.

Where to Get z/VM Information

z/VM product information is available from the following sources:

- z/VM Information Center at publib.boulder.ibm.com/infocenter/zvm/v6r1/index.jsp
- z/VM Internet Library at www.ibm.com/eserver/zseries/zvm/library/
- IBM Publications Center at www.elink.ibmink.ibm.com/publications/servlet/pbi.wss
- *IBM Online Library: z/VM Collection on DVD*, SK5T-7054

z/VM Base Library

Overview

- *z/VM: General Information*, GC24-6193
- *z/VM: Glossary*, GC24-6195
- *z/VM: License Information*, GC24-6200

Installation, Migration, and Service

- *z/VM: Guide for Automated Installation and Service*, GC24-6197
- *z/VM: Migration Guide*, GC24-6201
- *z/VM: Service Guide*, GC24-6232
- *z/VM: VMSES/E Introduction and Reference*, GC24-6243

Planning and Administration

- *z/VM: CMS File Pool Planning, Administration, and Operation*, SC24-6167
- *z/VM: CMS Planning and Administration*, SC24-6171
- *z/VM: Connectivity*, SC24-6174
- *z/VM: CP Planning and Administration*, SC24-6178
- *z/VM: Getting Started with Linux on System z*, SC24-6194
- *z/VM: Group Control System*, SC24-6196

- *z/VM: I/O Configuration*, SC24-6198
- *z/VM: Running Guest Operating Systems*, SC24-6228
- *z/VM: Saved Segments Planning and Administration*, SC24-6229
- *z/VM: Secure Configuration Guide*, SC24-6230
- *z/VM: TCP/IP LDAP Administration Guide*, SC24-6236
- *z/VM: TCP/IP Planning and Customization*, SC24-6238
- *z/OS and z/VM: Hardware Configuration Manager User's Guide*, SC33-7989

Customization and Tuning

- *z/VM: CP Exit Customization*, SC24-6176
- *z/VM: Performance*, SC24-6208

Operation and Use

- *z/VM: CMS Commands and Utilities Reference*, SC24-6166
- *z/VM: CMS Pipelines Reference*, SC24-6169
- *z/VM: CMS Pipelines User's Guide*, SC24-6170
- *z/VM: CMS Primer*, SC24-6172
- *z/VM: CMS User's Guide*, SC24-6173
- *z/VM: CP Commands and Utilities Reference*, SC24-6175
- *z/VM: System Operation*, SC24-6233
- *z/VM: TCP/IP User's Guide*, SC24-6240
- *z/VM: Virtual Machine Operation*, SC24-6241
- *z/VM: XEDIT Commands and Macros Reference*, SC24-6244
- *z/VM: XEDIT User's Guide*, SC24-6245
- *CMS/TSO Pipelines: Author's Edition*, SL26-0018

Application Programming

- *z/VM: CMS Application Development Guide*, SC24-6162
- *z/VM: CMS Application Development Guide for Assembler*, SC24-6163
- *z/VM: CMS Application Multitasking*, SC24-6164
- *z/VM: CMS Callable Services Reference*, SC24-6165
- *z/VM: CMS Macros and Functions Reference*, SC24-6168

- *z/VM: CP Programming Services*, SC24-6179
- *z/VM: CPI Communications User's Guide*, SC24-6180
- *z/VM: Enterprise Systems Architecture/ Extended Configuration Principles of Operation*, SC24-6192
- *z/VM: Language Environment User's Guide*, SC24-6199
- *z/VM: OpenExtensions Advanced Application Programming Tools*, SC24-6202
- *z/VM: OpenExtensions Callable Services Reference*, SC24-6203
- *z/VM: OpenExtensions Commands Reference*, SC24-6204
- *z/VM: OpenExtensions POSIX Conformance Document*, GC24-6205
- *z/VM: OpenExtensions User's Guide*, SC24-6206
- *z/VM: Program Management Binder for CMS*, SC24-6211
- *z/VM: Reusable Server Kernel Programmer's Guide and Reference*, SC24-6220
- *z/VM: REXX/VM Reference*, SC24-6221
- *z/VM: REXX/VM User's Guide*, SC24-6222
- *z/VM: Systems Management Application Programming*, SC24-6234
- *z/VM: TCP/IP Programmer's Reference*, SC24-6239
- *Common Programming Interface Communications Reference*, SC26-4399
- *Common Programming Interface Resource Recovery Reference*, SC31-6821
- *z/OS: IBM Tivoli Directory Server Plug-in Reference for z/OS*, SA76-0148
- *z/OS: Language Environment Concepts Guide*, SA22-7567
- *z/OS: Language Environment Debugging Guide*, GA22-7560
- *z/OS: Language Environment Programming Guide*, SA22-7561
- *z/OS: Language Environment Programming Reference*, SA22-7562
- *z/OS: Language Environment Run-Time Messages*, SA22-7566
- *z/OS: Language Environment Writing ILC Applications*, SA22-7563
- *z/OS MVS Program Management: Advanced Facilities*, SA22-7644
- *z/OS MVS Program Management: User's Guide and Reference*, SA22-7643

Diagnosis

- *z/VM: CMS and REXX/VM Messages and Codes*, GC24-6161
- *z/VM: CP Messages and Codes*, GC24-6177
- *z/VM: Diagnosis Guide*, GC24-6187
- *z/VM: Dump Viewing Facility*, GC24-6191
- *z/VM: Other Components Messages and Codes*, GC24-6207
- *z/VM: TCP/IP Diagnosis Guide*, GC24-6235
- *z/VM: TCP/IP Messages and Codes*, GC24-6237
- *z/VM: VM Dump Tool*, GC24-6242
- *z/OS and z/VM: Hardware Configuration Definition Messages*, SC33-7986

z/VM Facilities and Features

Data Facility Storage Management Subsystem for VM

- *z/VM: DFSMS/VM Customization*, SC24-6181
- *z/VM: DFSMS/VM Diagnosis Guide*, GC24-6182
- *z/VM: DFSMS/VM Messages and Codes*, GC24-6183
- *z/VM: DFSMS/VM Planning Guide*, SC24-6184
- *z/VM: DFSMS/VM Removable Media Services*, SC24-6185
- *z/VM: DFSMS/VM Storage Administration*, SC24-6186

Directory Maintenance Facility for z/VM

- *z/VM: Directory Maintenance Facility Commands Reference*, SC24-6188
- *z/VM: Directory Maintenance Facility Messages*, GC24-6189
- *z/VM: Directory Maintenance Facility Tailoring and Administration Guide*, SC24-6190

Open Systems Adapter/Support Facility

- *System z10, System z9 and eServer zSeries: Open Systems Adapter-Express Customer's Guide and Reference*, SA22-7935
- *System z9 and eServer zSeries 890 and 990: Open Systems Adapter-Express Integrated Console Controller User's Guide*, SA22-7990

- *System z: Open Systems Adapter-Express Integrated Console Controller 3215 Support*, SA23-2247

Performance Toolkit for VM™

- *z/VM: Performance Toolkit Guide*, SC24-6209
- *z/VM: Performance Toolkit Reference*, SC24-6210

RACF® Security Server for z/VM

- *z/VM: RACF Security Server Auditor's Guide*, SC24-6212
- *z/VM: RACF Security Server Command Language Reference*, SC24-6213
- *z/VM: RACF Security Server Diagnosis Guide*, GC24-6214
- *z/VM: RACF Security Server General User's Guide*, SC24-6215
- *z/VM: RACF Security Server Macros and Interfaces*, SC24-6216
- *z/VM: RACF Security Server Messages and Codes*, GC24-6217
- *z/VM: RACF Security Server Security Administrator's Guide*, SC24-6218
- *z/VM: RACF Security Server System Programmer's Guide*, SC24-6219
- *z/VM: Security Server RACROUTE Macro Reference*, SC24-6231

Remote Spooling Communications Subsystem Networking for z/VM

- *z/VM: RSCS Networking Diagnosis*, GC24-6223
- *z/VM: RSCS Networking Exit Customization*, SC24-6224
- *z/VM: RSCS Networking Messages and Codes*, GC24-6225
- *z/VM: RSCS Networking Operation and Use*, SC24-6226
- *z/VM: RSCS Networking Planning and Configuration*, SC24-6227
- *Network Job Entry: Formats and Protocols*, SA22-7539

Prerequisite Products

Device Support Facilities

- *Device Support Facilities: User's Guide and Reference*, GC35-0033

Environmental Record Editing and Printing Program

- *Environmental Record Editing and Printing Program (EREP): Reference*, GC35-0152
- *Environmental Record Editing and Printing Program (EREP): User's Guide*, GC35-0151

Additional publications

z/OS Language Environment

- *z/OS: Language Environment Concepts Guide*, SA22-7567
- *z/OS: Language Environment Programming Guide*, SA22-7561
- *z/OS: Language Environment Programming Reference*, SA22-7562
- *z/OS: Language Environment Debugging Guide*, GA22-7560
- *z/OS: Language Environment Writing ILC Applications*, SA22-7563
- *z/OS: Language Environment Run-Time Messages*, SA22-7566

Index

Special characters

- __csplist macro 108
- __osplist macro 108
- __pcblist macro 108
- __R1 macro 108
- @DELETE service routine for preinitialization
 - components of 51
 - return/reason codes for 51
- @EXCEPRTN service routine for preinitialization
 - return/reason codes for 54
- @FREESTORE service routine for preinitialization
 - return/reason codes for 52
- @GETSTORE service routine for preinitialization
 - return/reason codes for 52
- @LOAD service routine for preinitialization
 - components of 50
 - return/reason codes for 50
- @MSGRTN service routine for preinitialization
 - components of 55
 - return/reason codes for 55
- #pragma directives
 - See pragma
- c89 utility
 - build object modules 23
 - interface to the linkage editor 23

A

- abend codes
 - abend 2106, reason code 7205 121
 - abend 4093, reason code 60 113
 - CEEAEU_RETC field of CEEBXITA and 45
- abends
 - CICS
 - assembler user exit and EXEC CICS ABEND 46
 - dump, requesting in CEEBXITA assembler user exit 47
 - nested enclaves and
 - created by C system() 67
 - created by CMSCALL 63
 - created by SVC LINK 63
- abnormal termination
 - See abends
- ACCEPT statement 37
- addressing mode
 - See AMODE
- AMODE
 - (24 | 31 | ANY) LOAD command option 10
 - for CEEBXITA user exit 44
 - specifying addressing mode on CMS LOAD command 10
- application
 - See also enclave
 - building using c89 23
- argc parameter for C
 - C parameter passing styles and 110

- argument
 - list format
 - EXECOPS run-time option and 109, 110
 - how interactions of EXECOPS and PLIST run-time options affect 110
 - PLIST run-time option and 109
 - passing
 - C passing for operating systems and subsystems 107
 - specifying to an invoked routine which format to expect (C) 109
- argv parameter for C
 - C parameter passing styles and 110
- ASSEMBLE file 29
- assembler language
 - COBOL parameter list format 111
 - system programming C considerations 125
 - user exit
 - See CEEBXITA assembler user exit
- AUTO | NOAUTO prelinker option 95
- automatic library call processing
 - See library call processing

B

- binder interface
 - c89 utility 23
- building freestanding applications
 - including alternate initialization routines for 119
 - VM/CMS 119
- BYVALUE compiler option
 - required if SYSTEM(CICS) specified 111

C

- C
 - #pragmas
 - See pragma
 - building system exit routines 121
 - examples
 - freestanding VM routines 120
 - exit() function
 - EDCXEXIT routine and 120
 - functions
 - See main routine
 - See subroutine
 - L-names
 - See L-names
 - LONGNAME compiler option 93
 - NOSTART compiler option 119
 - OPTIMIZE(2) compiler option 121
 - parameter passing, for operating systems and subsystems
 - PLIST and EXECOPS interactions 109
 - styles 107
 - pragma
 - See pragma

C (*continued*)

- prelinker
 - See prelinker
- S-names
 - See S-names
- stderr
 - default destinations of 35
 - interleaving output with other output 36
 - redirecting output from 36
 - system programming facilities
 - See system programming facility, C
- C370LIB EXEC 113
- c89 utility
 - See OpenExtensions, c89 utility
- CALL statement
 - for PL/I
 - See FETCH statement
- casting, when using R1 and osplist macros 108
- CC EXEC
 - creating object library 113
- CEEAUE_A_AB_CODES
 - description 48
- CEEAUE_A_CC_PLIST 47
- CEEAUE_A_OPTIONS 47
- CEEAUE_ABND 47
- CEEAUE_ABTERM 46
- CEEAUE_DUMP 47
- CEEAUE_FBCODE 48
- CEEAUE_FLAGS
 - CEEAUE_ABND field of 47
 - CEEAUE_ABTERM field of 46
 - CEEAUE_DUMP field of 47
 - CEEAUE_STEPS field of 47
 - format 46
- CEEAUE_FUNC 45
- CEEAUE_LEN 45
- CEEAUE_RETC
 - description 45
 - relationship to CEEAUE_ABND 45, 46
 - relationship to CEEAUE_RSNC 46
- CEEAUE_RSNC
 - description 46
 - relationship to CEEAUE_ABND 46
 - relationship to CEEAUE_RETC 46
- CEEAUE_STEPS 47
- CEEAUE_USERWD 47
- CEEAUE_WORK 47
- CEEBINT HLL user exit
 - when invoked 43
- CEEBLDTX utility
 - error messages 31
 - using to create message files 29
- CEEBXITA assembler user exit
 - AMODE/RMODE considerations 44
 - application-specific 41
 - behavior of
 - during enclave initialization 43
 - during enclave termination 44
 - functions 41
 - installation-wide 41
- CEEBXITA assembler user exit (*continued*)
 - interface to
 - See also CXIT control block
 - diagram of 44
 - modifications to, rules for making 44
 - specifying run-time options in 47
 - when invoked 43
 - work area for 47
- CEECXITA assembler user exit
 - See CEEBXITA assembler user exit
- CEEDUMP default dump file
 - CEEBXITA assembler user exit and 44
- CEESTART
 - LOAD command and 11
 - specify RESET CEESTART for C main routines 9
- CEEOPT macro 25
- CESE transient data queue
 - message handling and 35
- CICS
 - See also EXEC CICS command
 - COBOL parameter list formats 111
 - PLIST and EXECOPS interactions 109
 - SYSTEM setting 111
- CLISTs for TSO
 - CPLINK 103
- CMOD EXEC
 - C prelinker and 104
 - syntax description 15
- CMS
 - building freestanding applications 119, 125
 - building persistent C environments 121
 - building system exit routines 121
 - CMOD 15, 17, 104
 - COBOL parameter list formats 111
 - CPLINK
 - example using 104
 - syntax description 103
 - dynamically loaded routines
 - search order for 8
 - where installed 4
- EXECs
 - See CMS, return code considerations
- LINKLOAD EXEC 17
- loading for
 - basics 5
 - FILEDEF command and 14
 - GENMOD command and 12, 14
 - INCLUDE command and 12
 - LKED command and 14
 - methods of 5
 - options 10
- OSRUN command
 - See OSRUN command for CMS
- PLIST and EXECOPS interactions 109, 110
- prelinking for
 - automatic library call processing 95
 - invoking the prelinker 103
 - prelinker input 94
 - prelinking options 104
 - return code considerations 27

CMS (*continued*)
 running for
 basics 5
 GENMOD command and 12, 20
 GLOBAL command and 6
 LKED command and 20
 START command and 18
 SYSTEM setting 111
 using system programming facilities 119, 125
 where library routines are stored 3
 CMSTPL SYSTEM setting 111
 COBOL
 non-CICS OS/VS COBOL programs supported in
 single enclave only 62
 parameter list formats 111
 STOP RUN statement
 CEEEXITA assembler user exit and 42
 code packaging 3
 command processor parameter list (CPPL)
 PLIST, EXECOPS and 110
 condition
 nested 65
 severity
 CEEEXITA assembler user exit and 46
 condition handling
 nested enclaves
 created by C system() 66
 created by CMSCALL 63, 64
 created by SVC LINK 63, 64
 with a PL/I fetchable main 66, 68
 constructed reentrancy
 See prelinker
 COPY file 29
 CPLINK EXEC
 example using 120
 syntax description 103
 CPPL (command processor parameter list)
 See command processor parameter list (CPPL)
 cross system product (CSP) 108
 csplist macro 108
 CXIT control block
 CEEAEU_A_CC_PLIST field of 47
 CEEAEU_A_OPTIONS field of 47
 CEEAEU_FBCODE field of 48
 CEEAEU_FLAGS field of
 CEEAEU_DUMP field of 47
 CEEAEU_STEPS field of 47
 format of the 46
 CEEAEU_FUNC field of 45
 CEEAEU_LEN field of 45
 CEEAEU_WORK field of 47

D

DELETE service routine for preinitialization
 components of 51
 return/reason codes for 51
 dereferencing 108
 diagnosis checklist 79
 DISPLAY statement
 default file for 37

dump
 CEEEXITA assembler user exit and 47
 dynamic routines 3

E

enclave
 nested
 created by C system() function 61, 65
 created by CMSCALL 61, 62, 64
 created by SVC LINK 62, 64
 enclave with a PL/I fetchable main routine 66, 68
 termination
 with abend 46
 entry point
 running default entry point under CMS 18
 ESD map of defined and longnames 98
 examples
 CMOD EXEC 104
 freestanding C MVS routine 120
 freestanding C VM routine 119
 GENMOD command for CMS 119
 building freestanding VM routine 120
 including alternate initialization routines 119
 GLOBAL command 119
 building freestanding routine 119
 including alternate initialization routines
 CMS 119
 invoking the prelinker
 from CMS 103
 linking and running under CMS 5
 LOAD command for CMS
 building freestanding VM routine 120
 including alternate initialization routines 121
 loading files under CMS 10
 relinking PL/I applications 4
 using PL/I routine as nucleus extension 13
 EXCEPRTN service routine for preinitialization
 return/reason codes for 54
 EXEC CICS command
 ABEND 46
 EXECOPS run-time option
 CMS START command and 18, 19
 interaction with PLIST run-time option, under
 CMS 110
 MVS argument list format and 109
 EXECs for CMS
 See CMS, return code considerations
 EXECs, IBM-supplied
 C370LIB 113
 LINKLOAD 114
 EXHIBIT for OS/VS COBOL
 default output file of 37
 no support for, under CICS 37
 exit() function
 system programming facilities and 120
 extended parameter list for CMS 21

F

FETCH statement
 fetchable main
 discussion of 66, 68
 reentrancy considerations of 67

FILEDEF command for CMS
 during enclave initialization 44
 example of 14, 15
 SYSABEND PRINTER 47
 SYSMDUMP PRINTER 47
 SYSUDUMP PRINTER 47
 using to relate a ddname to an I/O device 14

FILENAME option
 TXTLIB command 113

fprintf function 36

freestanding application
 alternate initialization routines for 119
 building
 VM 119, 121

FREESTORE service routine for preinitialization
 return/reason codes for 52

freopen 36

G

GENMOD command for CMS
 example 13, 119, 120
 executing module produced by 20
 link-editing process and 5, 12
 LOAD command, LKED command and 19
 syntax description 12

genxlt
 EXEC 19
 utility
 CMS 19

GETSTORE service routine for preinitialization
 return/reason codes for 52

global assembler user exit 41

GLOBAL command for CMS
 alternate initialization routines and 119
 freestanding C applications and 119
 GENMOD command and 20
 LOAD command and 6
 START command and 18

global error table
 See condition handling

H

header files
 stdlib.h and the __R1 and __osplist macros 108

I

I/O
 See input/output

iconv
 EXEC 19
 utility
 CMS 19

IMS (Information Management System)
 C considerations 108
 PLIST considerations
 PLIST and EXECOPS interactions 110
 SYSTEM(IMS) compiler option and
 how parameters are passed under 111, 113

INCLUDE command for CMS
 application-specific assembler user exit and 42
 example using 12
 options for 10
 syntax description 12
 using multiple times 12

INCLUDE file 29

INCLUDE statement
 for MVS
 application-specific assembler user exit and 42
 C prelinker and 95

Information Management System (IMS)
 See IMS (Information Management System)

initializing
 alternate initialization routines 119
 initialization routines 3
 nested enclave
 CEEBOXITA's function code for 45
 using CEEBOXITA assembler user exit for
 function code for 45

input/output
 FILEDEF statement and 4, 14
 Language Environment default message file
 attributes 34

installation-wide assembler user exit 41

interleaved
 output 36

L

L-names
 LIBRARY control statement and 101
 mapping to S-names 102
 RENAME control statement and 101
 resolving undefined 95
 unresolved 95
 UPCASE prelink option and 104

library call processing
 prelinker and 95

LIBRARY statement
 prelinker and 101

link-editing
 for TSO
 basics of linking and running 4

linkage editor
 function 3

LINKLOAD EXEC
 #pragma linkage and 17
 options 114
 options for 17
 syntax description 17

LKED command for CMS
 example using 15
 FILEDEF command and 14
 LOAD command, GENMOD command and 19

LKED command for CMS (*continued*)
 running module produced by 20
 syntax description 14

LOAD command for CMS
 alternate initialization routines and 119
 C System Exit routines and 121
 example using 9
 freestanding applications and 120
 GENMOD command, LKED command and 19
 GLOBAL commands and 6
 options for 10
 persistent C environment and 121
 syntax description 9
 using multiple times 12

LOAD service routine for preinitialization
 components of 50
 return/reason codes for 50

LOADLIB for CMS
 LKED command and 15
 running under CMS and 20, 21
 search order of 8

LONGNAME compiler option 93
 longname support 113

M

macro
 __csplist 108
 __osplist 108
 __pcblist 108
 __R1 108

main routine
 nested enclave considerations 61

map heading 116

mapping
 L-names to S-names 102

member heading 116

message
 directing to an I/O device 35
 using in your application 35

message file
 C stderr and stdout output and 36
 CICS considerations 35
 COBOL DISPLAY statement and 38
 Language Environment's default destinations 34
 nested enclave considerations 70
 PL/I I/O statements 38
 specifying ddname of 35
 using CEEBLDTX to assemble 29

message handling
 specifying ddname of message file 35

message module table 29

MSGFILE run-time option
 default destinations under different operating systems 35
 under OpenExtensions 35

MSGRTN service routine for preinitialization
 components of 55
 return/reason codes for 55

N

naming convention for object library members 114

nested enclave
See also enclave, nested
See SVC LINK

nonoverrideable 47

NOOE prelinker option 24

Notices 125

nucleus extension
 Language Environment library routines and 4
 routine search order in CMS running procedure 8

O

object library utility 113
 adding object modules 113
 deleting object modules 113
 example 114
 listing the contents 113

Object Library Utility 113

OE prelinker option 24

OpenExtensions 23, 26
 building and running, basic 23
 building C applications 23
 building PL/I applications 26
 c89 utility
 -c option 23
 -o option 23
 -W option 24
 default prelinker settings 24
 forced prelinker settings 24
 OE option 24
 environments supported 23, 25
 MSGFILE run-time option and 35
 prelinking under 24
 run-time options under 25
 running
 C applications 25, 26
 from z/OS UNIX shell 25, 26

OPTIONS(BYADDR)
 assembler calling PL/I under IMS 111
 SYSTEM(CICS) and 111

OPTIONS(BYVALUE)
 IMS considerations 111
 SYSTEM(CICS) and 111

osplist macro 108

OSRUN command for CMS
 GLOBAL command and 20
 LKED command and 20
 PLIST and EXECOPS run-time options and 110
 PLIST run-time option and 109, 110
 syntax description 20

overrideable/nonoverrideable 47

P

parameter
 list format
 effect of EXECOPS run-time option on 109, 110

parameter (*continued*)
 list format (*continued*)
 how interaction of EXECOPS and PLIST run-time options affects 110
 PLIST run-time option and 109
 passing
 C passing styles 107
 pcblist macro 108
 persistent C environment 121
 PL/I
 BYADDR 111
 BYVALUE
 must be specified if SYSTEM(IMS) or SYSTEM(CICS) specified 111
 nucleus extension, using PL/I routine as 13
 SYSTEM compiler option
 interactions with NOEXECOPS 111, 113
 PLIST run-time option
 argument list format and 109, 110
 HOST setting and portability 109
 interaction with EXECOPS run-time option, under CMS 110
 pragma
 #pragma linkage 17
 #pragma runopts
 affecting argument list format with 109, 110
 preinitialization facility 49
 prelinker
 functions 94
 how it maps L-names to S-names 102
 how it resolves undefined symbols 95
 INCLUDE statement and 100
 input 94
 invoking
 for VM/CMS 103
 LIBRARY statement and 101
 prelink options 104
 prelinker map 96
 RENAME statement and 101
 when it has to be used 93
 preventive service planning (PSP) bucket 79
 printf() function
 default destination 36
 interspersing messages into an application 35
 process
 assembler user exit for termination of 45
 program
 building using c89 23
 PSP (preventive service planning) bucket 79

R

R1 macro 108
 reason code
 in user exits 46
 reentrancy
 C Systems Programming Environment and modified CEEBXITA must be reentrant 44
 relocatable load module 4, 8

RENAME control statement
 how prelinkage utility maps L-names to S-names 102
 syntax and usage notes 101
 RENT compiler option
 prelinker must be used when C source file compiled with 93
 resident routines 3
 return code
 CEEAUE_RETC field of CEEBXITA and 45
 CMS considerations 27
 in user exits 45
 RTLS run-time option
 with CEEAUE_A_OPTIONS output string 47
 run-time options
 EXECOPS — let run-time options be specified on command line
 See EXECOPS run-time option
 how nested enclaves get
 enclaves created by C system() 65
 enclaves created by CMSCALL 62
 enclaves created by SVC LINK 62
 in the user exit 44, 47
 MSGFILE — specify ddname of diagnostic file
 See MSGFILE run-time option
 PLIST — specify format of C arguments
 See PLIST run-time option
 RTLS — modify search order when modules are loaded
 See RTLS run-time option
 TRAP — handle abends and program interrupts
 See TRAP run-time option

S

S-names
 prelinker and
 how L-names are mapped to S-names 102
 how S-names found in input are handled 94
 how unresolved S-names are handled 95
 saved segments 8
 Language Environment library routines and 4
 routine search order in CMS running procedure 8
 SCEELKED link library
 C system programming facility of C and 120
 CMS load procedures and 7, 15
 code packaging and 3
 SCEERUN load library
 CMS load/run procedures and 20
 code packaging and 4
 search order
 dynamically loaded routines for CMS 8
 severity
 of a condition
 CEEBXITA assembler user exit and 46
 signal()
 See condition handling
 standard streams 36
 START command for CMS 18
 stderr
 default destinations of 35

subroutine
 restriction regarding nested enclaves 61
SVC LINK 62
symbol information 117
SYSABEND PRINTER 47
SYSIN 44
SYSMDUMP PRINTER 47
SYSOUT
 CEEBOXITA assembler user exit and 44
 default destinations of MSGFILE run-time option 34
 destination when inserting messages in your
 application 38
system programming facility, C 119, 125
 building freestanding applications 119
 persistent C environments 121
 reentrant modules 120
 summary of functions 122
 system exit routines 121
 user-server environments 121
SYSUDUMP PRINTER 47

T

termination
 enclave
 as indicated in CEEAUE_ABND field of
 CEEAEU_FLAGS 46
 as indicated in CEEAUE_ABTERM field of
 CEEAEU_FLAGS 46
 CEEBOXITA function codes for 45
 process
 CEEBOXITA function code for 45
TRAP run-time option
 how CEEAUE_ABND is affected by 46
 nested enclaves and
 enclaves created by C system() 66
 enclaves with a C or assembler main, created by
 CMSCALL 63, 64
 enclaves with a C or assembler main, created by
 SVC LINK 63, 64
 enclaves with a COBOL main, created by
 CMSCALL 64
 enclaves with a COBOL main, created by SVC
 LINK 64
 enclaves with a PL/I fetchable main 66, 68
TXTLIB
 creating 113
TXTLIB command
 FILENAME option 113
TXTLIB for CMS 8, 14

U

user
 exit
 assembler 44
 for initialization 44
 for termination 44
 system exits in C Systems Programming
 Environment 121
 under CICS 45, 47

user (*continued*)
 return code
 See return code
user comments 117
user-server environment 121

W

writable static
 handled by prelinker 94
writable static map 96

X

XITPTR 44



Program Number: 5741-A05

Printed in USA

SC24-6199-00

