

z/OS



TSO/E REXX User's Guide

z/OS



TSO/E REXX User's Guide

Note

Before using this information and the product it supports, be sure to read the general information under "Appendix D. Notices" on page 205.

Second Edition, October 2001

This edition applies to Version 1 Release 2 of z/OS (5694-A01) and to all subsequent releases and modifications until otherwise indicated in new editions.

This is a maintenance revision of SA22-7791-00.

Order publications through your IBM representative or the IBM branch office serving your locality. Publications are not stocked at the address below.

IBM welcomes your comments. A form for readers' comments may be provided at the back of this publication, or you may address your comments to the following address:

International Business Machines Corporation
Department 55JA, Mail Station P384
2455 South Road
Poughkeepsie, NY 12601-5400
United States of America

FAX (United States & Canada): 1+845+432-9405

FAX (Other Countries):

Your International Access Code +1+845+432-9405

IBMLink (United States customers only): IBMUSM10(MHVRCFS)

Internet e-mail: mhvrcfs@us.ibm.com

World Wide Web: <http://www.ibm.com/servers/eserver/zseries/zos/webqs.html>

If you would like a reply, be sure to include your name, address, telephone number, or FAX number.

Make sure to include the following in your comment or note:

- Title and order number of this book
- Page number or topic related to your comment

When you send information to IBM, you grant IBM a nonexclusive right to use or distribute the information in any way it believes appropriate without incurring any obligation to you.

© Copyright International Business Machines Corporation 1988, 2001. All rights reserved.

US Government Users Restricted Rights – Use, duplication or disclosure restricted by GSA ADP Schedule Contract with IBM Corp.

Contents

Figures	ix
Tables	xi
About This Book	xiii
Who Should Use This Book	xiii
How This Book Is Organized	xiii
Terminology	xiii
Purpose of Each Chapter	xiv
Examples	xiv
Exercises	xiv
Where to Find More Information	xiv
Accessing Licensed Books on the Web	xiv
Using LookAt to Look Up Message Explanations	xv
Summary of Changes	xvii

Part 1. Learning the REXX Language. 1

Chapter 1. Introduction	3
What is REXX?	3
Features of REXX	3
Ease of use	3
Free format	4
Convenient built-in functions	4
Debugging capabilities	4
Interpreted language	4
Extensive parsing capabilities	4
Components of REXX	4
The SAA Solution	4
Benefits of Using a Compiler	5
Improved Performance	5
Reduced System Load	5
Protection for Source Code and Programs	6
Improved Productivity and Quality	6
Portability of Compiled Programs	6
SAA Compliance Checking	6
Chapter 2. Writing and Running a REXX Exec	7
Before You Begin	7
What is a REXX Exec?	8
Syntax of REXX Instructions	9
The Character Type of REXX Instructions	9
The Format of REXX Instructions	10
Types of REXX Instructions	12
Execs Using Double-Byte Character Set Names	14
Running an Exec	16
Running an Exec Explicitly	16
Running an Exec Implicitly	17
Interpreting Error Messages	19
Preventing Translation to Uppercase	20
From Within an Exec	20
As Input to an Exec	20

Passing Information to an Exec	21
Using Terminal Interaction	21
Specifying Values when Invoking an Exec	22
Preventing Translation of Input to Uppercase	23
Passing Arguments	24
Chapter 3. Using Variables and Expressions	25
Using Variables	25
Variable Names	26
Variable Values	27
Exercises - Identifying Valid Variable Names	27
Using Expressions	28
Arithmetic Operators	28
Comparison Operators	30
Logical (Boolean) Operators	32
Concatenation Operators	34
Priority of Operators	35
Tracing Expressions with the TRACE Instruction	37
Tracing Operations	37
Tracing Results	38
Chapter 4. Controlling the Flow Within an Exec	41
Using Conditional Instructions	42
IF/THEN/ELSE Instructions	42
Nested IF/THEN/ELSE Instructions	43
SELECT/WHEN/OTHERWISE/END Instruction	44
Using Looping Instructions	47
Repetitive Loops	47
Conditional Loops	52
Combining Types of Loops	55
Nested DO Loops	55
Using Interrupt Instructions	56
EXIT Instruction	57
CALL/RETURN Instructions	57
SIGNAL Instruction	58
Chapter 5. Using Functions	61
What is a Function?	61
Example of a Function	62
Built-In Functions	63
Arithmetic Functions	63
Comparison Functions	63
Conversion Functions	64
Formatting Functions	64
String Manipulating Functions	64
Miscellaneous Functions	65
Testing Input with Built-In Functions	66
Chapter 6. Writing Subroutines and Functions	69
What are Subroutines and Functions?	69
When to Write Subroutines vs. Functions	70
Writing a Subroutine	70
Passing Information to a Subroutine	72
Receiving Information from a Subroutine	75
Writing a Function	77
Passing Information to a Function	79

Receiving Information from a Function	83
Summary of Subroutines and Functions.	83
Chapter 7. Manipulating Data	85
Using Compound Variables and Stems	85
What is a Compound Variable?	85
Using Stems.	86
Parsing Data.	87
Instructions that Parse	88
Ways of Parsing	89
Parsing Multiple Strings as Arguments	92

Part 2. Using REXX 95

Chapter 8. Entering Commands from an Exec	97
Types of Commands	97
Issuing TSO/E Commands from an Exec	98
Using Quotations Marks in Commands	98
Using Variables in Commands	99
Causing Interactive Commands to Prompt the User	100
Invoking Another Exec as a Command.	100
Issuing Other Types of Commands from an Exec.	101
What is a Host Command Environment?	101
Changing the Host Command Environment	106

Chapter 9. Diagnosing Problems Within an Exec	111
Debugging Execs	111
Tracing Commands with the TRACE Instruction	111
Using REXX Special Variables RC and SIGL	112
Tracing with the Interactive Debug Facility	113

Chapter 10. Using TSO/E External Functions	119
TSO/E External Functions	119
Using the GETMSG Function	120
Using the LISTDSI Function	120
Using the MSG Function	122
Using the MVSVAR Function	123
Using the OUTTRAP Function.	123
Using the PROMPT Function	124
Using the SETLANG Function	125
Using the STORAGE Function.	126
Using the SYSCPUS Function.	126
Using the SYSDSN Function	126
Using the SYSVAR Function	127
Additional Examples	130
Function Packages	133
Search Order for Functions	134

Chapter 11. Storing Information in the Data Stack	135
What is a Data Stack?	135
Manipulating the Data Stack	136
Adding Elements to the Data Stack	136
Removing Elements from the Stack	137
Determining the Number of Elements on the Stack	137
Processing of the Data Stack	139
Using the Data Stack	140

Passing Information Between a Routine and the Main Exec	140
Passing Information to Interactive Commands	142
Issuing Subcommands of TSO/E Commands	142
Creating a Buffer on the Data Stack.	142
Creating a Buffer with the MAKEBUF Command	143
Dropping a Buffer with the DROPBUF Command	144
Finding the Number of Buffers with the QBUF Command	144
Finding the Number of Elements In a Buffer.	145
Protecting Elements in the Data Stack.	147
Creating a New Data Stack with the NEWSTACK Command	148
Deleting a Private Stack with the DELSTACK Command	149
Finding the Number of Stacks	149
Chapter 12. Processing Data and Input/Output Processing	153
Types of Processing	153
Dynamic Modification of a Single REXX Expression	153
Using the INTERPRET Instruction	153
Using EXECIO to Process Information to and from Data Sets	154
When to Use the EXECIO Command	154
Using the EXECIO Command	154
Return Codes from EXECIO	159
When to Use the EXECIO Command	159
Chapter 13. Using REXX in TSO/E and Other MVS Address Spaces	171
Services Available to REXX Execs	171
Running Execs in a TSO/E Address Space	173
Running an Exec in the Foreground.	173
Running an Exec in the Background	176
Running Execs in a Non-TSO/E Address Space	177
Using an Exec Processing Routine to Invoke an Exec from a Program	177
Using IRXJCL to Run an Exec in MVS Batch	178
Using the Data Stack in TSO/E Background and MVS Batch	180
Summary of TSO/E Background and MVS Batch	180
CAPABILITIES	180
REQUIREMENTS	181
Defining Language Processor Environments	181
What is a Language Processor Environment?	181
Customizing a Language Processor Environment.	182

Part 3. Appendixes 183

Appendix A. Allocating Data Sets	185
What is Allocation?	185
Where to Begin	186
Preliminary Checklist	186
Checklist #1: Creating and Editing a Data Set Using ISPF/PDF	187
Checklist #2: Creating a Data Set with the ALLOCATE Command.	190
Checklist #3: Writing an Exec that Sets up Allocation to SYSEXEC	191
Checklist #4: Writing an Exec that Sets up Allocation to SYSPROC	192
Appendix B. Specifying Alternate Libraries with the ALTLIB Command	195
Specifying Alternative Exec Libraries with the ALTLIB Command	195
Using the ALTLIB Command	195
Stacking ALTLIB Requests	196
Using ALTLIB with ISPF	196
Examples of the ALTLIB Command	196

Appendix C. Comparisons Between CLIST and REXX	197
Accessing System Information	198
Controlling Program Flow	199
Debugging	200
Execution	200
Interactive Communication	201
Passing Information.	201
Performing File I/O	202
Syntax	202
Using Functions	203
Using Variables	203
 Appendix D. Notices	 205
Programming Interface Information	207
Trademarks.	207
 Bibliography	 209
TSO/E Publications	209
Related Publications	209
 Index	 211

Figures

1.	EXECIO Example 1	164
2.	EXECIO Example 2	164
3.	EXECIO Example 3	165
4.	EXECIO Example 4	165
5.	EXECIO Example 5	166
6.	EXECIO Example 5 (continued)	167
7.	EXECIO Example 6	168
8.	EXECIO Example 6 (continued)	169
9.	EXECIO Example 6 (continued)	170

Tables

1. Language Codes for SETLANG Function That Replace the Function Call 125

About This Book

This book describes how to use the TSO/E Procedures Language MVS/REXX processor (called the language processor) and the REstructured eXtended eXecutor (REXX) language. Together, the language processor and the REXX language are known as TSO/E REXX. TSO/E REXX is the implementation of the Systems Application Architecture (SAA) Procedures Language on the MVS system.

Who Should Use This Book

This book is intended for anyone who wants to learn how to write REXX programs. More specifically, the audience is programmers who may range from the inexperienced to those with extensive programming experience, particularly in writing CLISTs for TSO/E. Because of the broad range of experience in readers, this book is divided into two parts.

- Part 1. Learning the REXX Language is for inexperienced programmers who are somewhat familiar with TSO/E commands and have used the Interactive System Productivity Facility/Program Development Facility (ISPF/PDF) in TSO/E. Programmers unfamiliar with TSO/E should first read the *z/OS TSO/E Primer*. Experienced programmers new to REXX can also read this section to learn the basics of the REXX language.
- Part 2. Using REXX is for programmers already familiar with the REXX language and experienced with the workings of TSO/E. It describes more complex aspects of the REXX language and how they work in TSO/E as well as in other MVS address spaces.

If you are a new programmer, you might want to concentrate on the first part. If you are an experienced TSO/E programmer, you might want to read the first part and concentrate on the second part.

How This Book Is Organized

In addition to the two parts described in the preceding paragraphs, there are three appendixes at the end of the book.

- “Appendix A. Allocating Data Sets” on page 185 contains checklists for the tasks of creating and editing a data set and for allocating a data set to a system file.
- “Appendix B. Specifying Alternate Libraries with the ALTLIB Command” on page 195 describes using the ALTLIB command.
- “Appendix C. Comparisons Between CLIST and REXX” on page 197 contains tables that compare the CLIST language with the REXX language.

Terminology

Throughout this book a REXX program is called an `exec` to differentiate it from other programs you might write, such as CLISTs. The command to run an `exec` in TSO/E is the `EXEC` command. To avoid confusion between the two, this book uses lowercase and uppercase to distinguish between the two uses of the term “`exec`”. References to the REXX program appear as `exec` and references to the TSO/E command appear as `EXEC`.

Purpose of Each Chapter

At the beginning of each chapter is a statement about the purpose of the chapter. Following that are headings and page numbers where you can find specific information.

Examples

Throughout the book, you will find examples that you can try as you read. If the example is a REXX keyword instruction, the REXX keyword is in uppercase. Information that you can provide is in lowercase. The following REXX keyword instruction contains the REXX keyword SAY, which is fixed, and a phrase, which can vary.

```
SAY 'This is an example of an instruction.'
```

Similarly, if the example is a TSO/E command, the command name and keyword operands, which are fixed, are in uppercase. Information that can vary, such as a data set name, is in lowercase. The following ALLOCATE command and its operands are in uppercase and the data set and file name are in lowercase.

```
"ALLOCATE DATASET(rexx.exec) FILE(sysexec) SHR REUSE"
```

This use of uppercase and lowercase is intended to make a distinction between words that are fixed and words that can vary. It does *not* mean that you must type REXX instructions and TSO/E commands with certain words in uppercase and others in lowercase.

Exercises

Periodically, you will find sections with exercises you can do to test your understanding of the information. Answers to the exercises are included when appropriate.

Where to Find More Information

Please see *z/OS Information Roadmap* for an overview of the documentation associated with z/OS, including the documentation available for z/OS TSO/E.

Accessing Licensed Books on the Web

z/OS licensed documentation in PDF format is available on the Internet at the IBM Resource Link Web site at:

```
http://www.ibm.com/servers/resourceLink
```

Licensed books are available only to customers with a z/OS license. Access to these books requires an IBM Resource Link Web userid and password, and a key code. With your z/OS order you received a memo that includes this key code.

To obtain your IBM Resource Link Web userid and password log on to:

```
http://www.ibm.com/servers/resourceLink
```

To register for access to the z/OS licensed books:

1. Log on to Resource Link using your Resource Link userid and password.
2. Click on **User Profiles** located on the left-hand navigation bar.
3. Click on **Access Profile**.
4. Click on **Request Access to Licensed books**.
5. Supply your key code where requested and click on the **Submit** button.

If you supplied the correct key code you will receive confirmation that your request is being processed. After your request is processed you will receive an e-mail confirmation.

Note: You cannot access the z/OS licensed books unless you have registered for access to them and received an e-mail confirmation informing you that your request has been processed.

To access the licensed books:

1. Log on to Resource Link using your Resource Link userid and password.
2. Click on **Library**.
3. Click on **zSeries**.
4. Click on **Software**.
5. Click on **z/OS**.
6. Access the licensed book by selecting the appropriate element.

Using LookAt to Look Up Message Explanations

LookAt is an online facility that allows you to look up explanations for z/OS messages and system abends.

Using LookAt to find information is faster than a conventional search because LookAt goes directly to the explanation.

LookAt can be accessed from the Internet or from a TSO command line.

You can use LookAt on the Internet at:

<http://www.ibm.com/servers/eserver/zseries/zos/bkserv/lookat/lookat.html>

To use LookAt as a TSO command, LookAt must be installed on your host system. You can obtain the LookAt code for TSO from the LookAt Web site by clicking on **News and Help** or from the *z/OS Collection*, SK3T-4269 .

To find a message explanation from a TSO command line, simply enter: **lookat** *message-id* as in the following example:

```
lookat iec192i
```

This results in direct access to the message explanation for message IEC192I.

To find a message explanation from the LookAt Web site, simply enter the message ID. You can select the release if needed.

Note: Some messages have information in more than one book. For example, IEC192I has routing and descriptor codes listed in *z/OS MVS Routing and Descriptor Codes*. For such messages, LookAt prompts you to choose which book to open.

Summary of Changes

This book is available in softcopy formats only. The most current version is available in HTML and PDF formats on the Web site at URL:

<http://www.ibm.com/servers/eserver/zseries/zos/>

Summary of Changes for SA22-7791-01 z/OS Version 1 Release 2

This book contains information previously presented in *z/OS TSO/E REXX User's Guide*, SA22-7791-00, which supports z/OS Version 1 Release 1.

New Information

- Reference information has been added to the z/OS UNIX callable services. See “What is REXX?” on page 3.

This book contains terminology, maintenance, and editorial changes. Technical changes or additions to the text and illustrations are indicated by a vertical line to the left of the change.

You may notice changes in the style and structure of some content in this book—for example, headings that use uppercase for the first letter of initial words only, and procedures that have a different look and format. The changes are ongoing improvements to the consistency and retrievability of information in our books.

Part 1. Learning the REXX Language

The REXX language is a versatile general-purpose programming language that can be used by new and experienced programmers. This part of the book is for programmers who want to learn the REXX language. The chapters in this part cover the following topics.

- “Chapter 1. Introduction” on page 3 — The REXX language has many features that make it a powerful programming tool.
- “Chapter 2. Writing and Running a REXX Exec” on page 7 — Execs are easy to write and have few syntax rules.
- “Chapter 3. Using Variables and Expressions” on page 25 — Variables, expressions, and operators are essential when writing execs that do arithmetic and comparisons.
- “Chapter 4. Controlling the Flow Within an Exec” on page 41 — You can use instructions to branch, loop, or interrupt the flow of an exec.
- “Chapter 5. Using Functions” on page 61 — A function is a sequence of instructions that can perform a specific task and must return a value.
- “Chapter 6. Writing Subroutines and Functions” on page 69 — You can write internal and external routines that are called by an exec.
- “Chapter 7. Manipulating Data” on page 85 — Compound variables and parsing are two ways to manipulate data.

Note: Although you can write a REXX exec to run in a non-TSO/E address space in MVS, the chapters and examples in this part assume the exec will run in a TSO/E address space. If you want to write execs that run outside of a TSO/E address space, keep in mind the following exceptions to information in Part 1:

- An exec that runs outside of TSO/E cannot include TSO/E commands, unless you use the TSO/E environment service (see note).
- In TSO/E, several REXX instructions either display information on the terminal or retrieve information that the user enters at the terminal. In a non-TSO/E address space, these instructions get information from the input stream and write information to the output stream.
 - SAY — this instruction sends information to the output DD whose default is SYSTSPRT.
 - PULL — this instruction gets information from the input DD whose default is SYSTSIN.
 - TRACE — this instruction sends information to the output DD whose default is SYSTSPRT.
 - PARSE EXTERNAL — this instruction gets information from the input DD whose default is SYSTSIN.
- The USERID built-in function, instead of returning a user identifier, might return a stepname or jobname.

Note: You can use the TSO/E environment service, IKJTSEV, to create a TSO/E environment in a non-TSO/E address space. If you run a REXX exec in the TSO/E environment you created, the exec can contain TSO/E commands, external functions, and services that an exec running in a TSO/E address space can use. That is, the TSO host command environment (ADDRESS TSO) is available to the exec. For more information about the TSO/E environment service and the different considerations for running REXX execs within the environment, see *z/OS TSO/E Programming Services*.

Chapter 1. Introduction

What is REXX?	3
Features of REXX	3
Ease of use	3
Free format	4
Convenient built-in functions	4
Debugging capabilities	4
Interpreted language	4
Extensive parsing capabilities	4
Components of REXX	4
The SAA Solution	4
Benefits of Using a Compiler	5
Improved Performance	5
Reduced System Load	5
Protection for Source Code and Programs	6
Improved Productivity and Quality	6
Portability of Compiled Programs	6
SAA Compliance Checking	6

This chapter describes the REXX programming language and some of its features.

What is REXX?

REXX is a programming language that is extremely versatile. Aspects such as common programming structure, readability, and free format make it a good language for beginners and general users. Yet because the REXX language can be intermixed with commands to different host environments, provides powerful functions and has extensive mathematical capabilities, it is also suitable for more experienced computer professionals.

The TSO/E implementation of the REXX language allows REXX execs to run in any MVS address space. You can write a REXX exec that includes TSO/E services and run it in a TSO/E address space, or you can write an application in REXX to run outside of a TSO/E address space. For more information, see “Chapter 13. Using REXX in TSO/E and Other MVS Address Spaces” on page 171.

There is also a set of z/OS UNIX extensions to the TSO/E Restructured Extended Executor (REXX) language which enable REXX programs to access z/OS UNIX callable services. The z/OS UNIX extensions, called syscall commands, have names that correspond to the names of the callable services that they invoke—for example, access, chmod, and chown. For more information about the z/OS UNIX extensions, see *z/OS Using REXX and z/OS UNIX System Services*.

Features of REXX

In addition to its versatility, REXX has many other features, some of which are:

Ease of use

The REXX language is easy to read and write because many instructions are meaningful English words. Unlike some lower-level programming languages that use abbreviations, REXX instructions are common words, such as SAY, PULL, IF... THEN... ELSE..., DO... END, and EXIT.

Features of REXX

Free format

There are few rules about REXX format. You need not start an instruction in a particular column, you can skip spaces in a line or skip entire lines, you can have an instruction span many lines or have multiple instructions on one line, variables do not need to be predefined, and you can type instructions in upper, lower, or mixed case. The few rules about REXX format are covered in “Syntax of REXX Instructions” on page 9.

Convenient built-in functions

REXX supplies built-in functions that perform various processing, searching, and comparison operations for both text and numbers. Other built-in functions provide formatting capabilities and arithmetic calculations.

Debugging capabilities

When a REXX exec running in TSO/E encounters an error, messages describing the error are displayed on the screen. In addition, you can use the REXX TRACE instruction and the interactive debug facility to locate errors in execs.

Interpreted language

TSO/E implements the REXX language as an interpreted language. When a REXX exec runs, the language processor directly processes each language statement. Languages that are not interpreted must be compiled into machine language and possibly link-edited before they are run. You can use the IBM licensed product, IBM Compiler and Library for REXX/370, to provide this function.

Extensive parsing capabilities

REXX includes extensive parsing capabilities for character manipulation. This parsing capability allows you to set up a pattern to separate characters, numbers, and mixed input.

Components of REXX

The various components of REXX are what make it a powerful tool for programmers. REXX is made up of:

- Instructions — There are five types of instructions. All but commands are processed by the language processor.
 - Keyword
 - Assignment
 - Label
 - Null
 - Command (both TSO/E REXX commands and host commands)
- Built-in functions — These functions are built into the language processor and provide convenient processing options.
- TSO/E external functions — These functions are provided by TSO/E and interact with the system to do specific tasks for REXX.
- Data stack functions — A data stack can store data for I/O and other types of processing.

The SAA Solution

The SAA solution is based on a set of software interfaces, conventions, and protocols that provide a framework for designing and developing applications.

The SAA Procedures Language has been defined as a subset of the REXX language. Its purpose is to define a common subset of the language that can be used in several environments. TSO/E REXX is the implementation of the SAA Procedures Language on the MVS system.

The SAA solution:

- Defines a **common programming interface** you can use to develop applications that can be integrated with each other and transported to run in multiple SAA environments.
- Defines **common communications support** that you can use to connect applications, systems, networks, and devices.
- Defines a **common user access** that you can use to achieve consistency in panel layout and user interaction techniques.
- Offers some applications and application development tools written by IBM.

Several combinations of IBM hardware and software have been selected as SAA environments. These are environments in which IBM will manage the availability of support for applicable SAA elements, and the conformance of those elements to SAA specifications. The SAA environments are the following:

- MVS
 - TSO/E
 - CICS
 - IMS
- VM CMS
- Operating System/400 (OS/400)
- Operating System/2 (OS/2)

Benefits of Using a Compiler

The IBM Compiler for REXX/370 (Program Number 5695-013) and the IBM Library for REXX/370 (Program Number 5695-014) provide significant benefits for programmers during program development and for users when a program is run. The benefits are:

- Improved performance
- Reduced system load
- Protection for source code and programs
- Improved productivity and quality
- Portability of compiled programs
- Checking for compliance to SAA

Improved Performance

The performance improvements that you can expect when you run compiled REXX programs depend on the type of program. A program that performs large numbers of arithmetic operations of default precision shows the greatest improvement. A program that mainly enters commands to the host shows minimal improvement because REXX cannot decrease the time taken by the host to process the commands.

Reduced System Load

Compiled REXX programs run faster than interpreted programs. Because a program has to be compiled only once, system load is reduced and response time is improved when the program is run frequently.

Benefits of Using a Compiler

For example, a REXX program that performs many arithmetic operations might take 12 seconds to run interpreted. If the program is run 60 times, it uses about 12 minutes of processor time. The same program when compiled might run six times faster, using only about 2 minutes of processor time.

Protection for Source Code and Programs

Your REXX programs and algorithms are assets that you want to protect.

The Compiler produces object code, which helps you protect these assets by discouraging people from making unauthorized changes to your programs. You can distribute your REXX programs in object code only.

Load modules can be further protected by using a security server, such as RACF.

Improved Productivity and Quality

The Compiler can produce source listings, cross-reference listings, and messages, which help you more easily develop and maintain your REXX programs.

The Compiler identifies syntax errors in a program before you start testing it. You can then focus on correcting errors in logic during testing with the REXX interpreter.

Portability of Compiled Programs

A REXX program compiled under MVS/ESA can run under CMS. Similarly, a REXX program compiled under CMS can run under MVS/ESA.

SAA Compliance Checking

The Systems Application Architecture (SAA) definitions of software interfaces, conventions, and protocols provide a framework for designing and developing applications that are consistent within and across several operating systems.

The SAA Procedures Language is a subset of the REXX language supported by the interpreter under TSO/E, and can be used in this operating environment.

To help you write programs for use in all SAA environments, the Compiler can optionally check for SAA compliance. With this option in effect, a warning message is issued for each non-SAA item found in a program.

For more information, see *IBM Compiler and Library for REXX/370; Introducing the Next Step in REXX Programming*.

Chapter 2. Writing and Running a REXX Exec

Before You Begin	7
What is a REXX Exec?	8
Syntax of REXX Instructions	9
The Character Type of REXX Instructions	9
Using Quotation Marks in an Instruction	9
The Format of REXX Instructions	10
Beginning an instruction	10
Continuing an instruction	10
Continuing a literal string without adding a space	11
Ending an instruction.	11
Types of REXX Instructions	12
Keyword	13
Assignment	13
Label	14
Null	14
Command.	14
Execs Using Double-Byte Character Set Names	14
Running an Exec	16
Running an Exec Explicitly	16
Running an Exec Implicitly	17
Allocating a PDS to a System File	17
Exercises - Running the Example Execs	18
Interpreting Error Messages	19
Preventing Translation to Uppercase	20
From Within an Exec.	20
As Input to an Exec	20
Exercises - Running and Modifying the Example Execs	21
Passing Information to an Exec	21
Using Terminal Interaction	21
Specifying Values when Invoking an Exec	22
Specifying Too Few Values	22
Specifying Too Many Values	22
Preventing Translation of Input to Uppercase	23
Exercises - Using the ARG Instruction	23
Passing Arguments	24
Passing Arguments Using the CALL Instruction or REXX Function Call	24
Passing Arguments Using the EXEC Command	24

This chapter introduces execs and their syntax, describes the steps involved in writing and running an exec, and explains concepts you need to understand to avoid common problems.

Before You Begin

Before you can write a REXX program, called an exec, you need to create a data set to contain the exec. The data set can be either sequential or partitioned, but if you plan to create more than one exec, it is easier to create a REXX library as a partitioned data set (PDS) with execs as members.

To create a PDS, allocate a data set with your prefix (usually your user ID) as the first qualifier, any name as the second qualifier, and preferably "exec" as the third qualifier. You can allocate the PDS with the Utilities option in ISPF/PDF or with the

Before You Begin

TSO/E ALLOCATE command. For specific information about allocating a data set for an exec, see “Appendix A. Allocating Data Sets” on page 185.

What is a REXX Exec?

A REXX exec consists of REXX language instructions that are interpreted directly by the REXX interpreter or compiled directly by a REXX language compiler and executed by a Compiler Runtime Processor. An exec can also contain commands that are executed by the host environment.

An advantage of the REXX language is its similarity to ordinary English. This similarity makes it easy to read and write a REXX exec. For example, an exec to display a sentence on the screen uses the REXX instruction SAY followed by the sentence to be displayed.

Example of a Simple Exec

```
/****** REXX *****/  
SAY 'This is a REXX exec.'
```

Note that this simple exec starts with a comment line to identify the program as a REXX exec. A comment begins with /* and ends with */. **To prevent incompatibilities with CLISTs, IBM recommends that all REXX execs start with a comment that includes the characters “REXX” within the first line (line 1) of the exec. Failure to do so can lead to unexpected or unintended results in your REXX exec.** More about comments and why you might need a REXX exec identifier appears later 14.

When you run the exec, you see on your screen the sentence:

```
This is a REXX exec.
```

Even in a longer exec, the instructions flow like ordinary English and are easy to understand.

Example of a Longer Exec

```
/****** REXX *****/  
/* This exec adds two numbers and displays their sum. */  
/******  
  
SAY 'Please enter a number.'  
PULL number1  
SAY 'Now enter a number to add to the first number.'  
PULL number2  
sum = number1 + number2  
SAY 'The sum of the two numbers is' sum'.'
```

When you run the example, the exec interacts with you at the terminal. First you see on your screen:

```
Please enter a number.
```

What is a REXX Exec?

When you type a number, for example 42, and press the Enter key, the variable `number1` is assigned the value 42. You then see another sentence on the screen.

```
Now enter a number to add to the first number.
```

When you enter another number, for example 21, the variable `number2` is assigned the value 21. Then the values in `number1` and `number2` are added and the total is assigned to `sum`. You see a final sentence on the screen displaying the sum.

```
The sum of the two numbers is 63.
```

Before you actually try these examples, please read the next two sections:

- “Syntax of REXX Instructions”
- “Running an Exec” on page 16

Syntax of REXX Instructions

Some programming languages have rigid rules about how and where characters are entered on each line. For example, CLIST statements must be entered in uppercase, and assembler statements must begin in a particular column. REXX, on the other hand, has simple syntax rules. There is no restriction on how characters are entered and generally one line is an instruction regardless of where it begins or where it ends.

The Character Type of REXX Instructions

You can enter a REXX instruction in lowercase, uppercase, or mixed case. However, alphabetic characters are changed to uppercase, unless you enclose them in single or double quotation marks.

Using Quotation Marks in an Instruction

A series of characters enclosed in matching quotation marks is called a *literal string*. The following examples both contain literal strings.

```
SAY 'This is a REXX literal string.'      /* Using single quotes */
```

```
SAY "This is a REXX literal string."    /* Using double quotes */
```

You cannot enclose a literal string with one each of the two types of quotation marks. The following is *not* a correct example of an enclosed literal string.

```
SAY 'This is a REXX literal string.'    /* Using mismatched quotes */
```

When you omit the quotation marks from a SAY instruction as follows:

```
SAY This is a REXX string.
```

you see the statement in uppercase on your screen.

```
THIS IS A REXX STRING.
```

Note: If any word in the statement is the name of a variable that has already been assigned a value, REXX substitutes the value. For information about variables, see “Using Variables” on page 25.

Syntax of REXX Instructions

If a string contains an apostrophe, you can enclose the literal string in double quotation marks.

```
SAY "This isn't a CLIST instruction."
```

You can also use two single quotation marks in place of the apostrophe, because a pair of single quotation marks is processed as one.

```
SAY 'This isn't a CLIST instruction.'
```

Either way, the outcome is the same.

```
This isn't a CLIST instruction.
```

The Format of REXX Instructions

The REXX language uses a free format. This means you can insert extra spaces between words and blank lines freely throughout the exec without causing an error. A line usually contains one instruction except when it ends with a comma (,) or contains a semicolon (;). A comma is the continuation character and indicates that the instruction continues to the next line. The comma, when used in this manner, also adds a space when the lines are concatenated. A semicolon indicates the end of the instruction and is used to separate multiple instructions on one line.

Beginning an instruction

An instruction can begin in any column on any line. The following are all valid instructions.

```
SAY 'This is a literal string.'  
      SAY 'This is a literal string.'  
                SAY 'This is a literal string.'
```

This example appears on the screen as follows:

```
This is a literal string.  
This is a literal string.  
This is a literal string.
```

Continuing an instruction

A comma indicates that the instruction continues to the next line. Note that a space is added between “extended” and “REXX” when it appears on the screen.

```
SAY 'This is an extended',  
    'REXX literal string.'
```

This example appears on the screen as one line.

```
This is an extended REXX literal string.
```

Also note that the following two instructions are identical and yield the same result when displayed on the screen:

```
SAY 'This is',  
    'a string.'
```

is functionally identical to:

```
SAY 'This is' 'a string.'
```

These examples appear on the screen as:

```
This is a string.
```

In the first example, the comma at the end of line 1 adds a space when the two lines are concatenated for display. In the second example, the space between the two separate strings is preserved when the line is displayed.

Continuing a literal string without adding a space

If you need to continue an instruction to a second or more lines but do not want REXX to add spaces when the line appears on the screen, use the concatenation operand (two single OR bars, ||).

```
SAY 'This is an extended literal string that is bro' ||,
    'ken in an awkward place.'
```

This example appears on the screen as one line without adding a space within the word “broken”.

```
This is an extended literal string that is broken in an awkward place.
```

Also note that the following two instructions are identical and yield the same result when displayed on the screen:

```
SAY 'This is' ||,
    'a string.'
```

is functionally identical to:

```
SAY 'This is' || 'a string.'
```

These examples appear on the screen as:

```
This isa string.
```

In the first example, the concatenation operator at the end of line 1 causes the deletion of any spaces when the two lines are concatenated for display. In the second example, the concatenation operator also concatenates the two strings without space when the line is displayed.

Ending an instruction

The end of the line or a semicolon indicates the end of an instruction. If you put more than one instruction on a line, you must separate each instruction with a semicolon. If you put one instruction on a line, it is best to let the end of the line delineate the end of the instruction.

```
SAY 'Hi!'; say 'Hi again!'; say 'Hi for the last time!'
```

This example appears on the screen as three lines.

```
Hi!
Hi again!
Hi for the last time!
```

The following example demonstrates the free format of REXX.

Syntax of REXX Instructions

Example of Free Format

```
/****** REXX *****/
SAY 'This is a REXX literal string.'
SAY      'This is a REXX literal string.'
  SAY 'This is a REXX literal string.'
SAY,
'This',
'is',
'a',
'REXX',
'literal',
'string.'

SAY'This is a REXX literal string. ';SAY'This is a REXX literal string.'
SAY '      This is a REXX literal string.'
```

When the example runs, you see six lines of identical output on your screen followed by one indented line.

```
This is a REXX literal string.
This is a REXX literal string.
This is a REXX literal string.
This is a REXX literal string.
This is a REXX literal string.
This is a REXX literal string.
      This is a REXX literal string.
```

Thus you can begin an instruction anywhere on a line, you can insert blank lines, and you can insert extra spaces between words in an instruction because the language processor ignores blank lines and spaces that are greater than one. This flexibility of format allows you to insert blank lines and spaces to make an exec easier to read.

Only when words are parsed do blanks and spaces take on significance. More about parsing is covered in “Parsing Data” on page 87.

Types of REXX Instructions

There are five types of REXX instructions: keyword, assignment, label, null, and command. The following example is an ISPF/PDF Edit panel that shows an exec with various types of instructions. A description of each type of instruction appears after the example. In most of the descriptions, you will see an edit line number (without the prefixed zeroes) to help you locate the instruction in the example.

```

EDIT ---- USERID.REXX.EXEC(TIMEGAME)----- COLUMNS 009 080
COMMAND ==>                                SCROLL ==> HALF
***** ***** TOP OF DATA *****
000001 /***** REXX *****/
000002 /* This is an interactive REXX exec that asks a user for the*/
000003 /* time and then displays the time from the TIME command. */
000004 /***** */
000005 Game1:
000006
000007 SAY 'What time is it?'
000008 PULL usertime                /* Put the user's response
000009                                into a variable called
000010                                "usertime" */
000011 IF usertime = '' THEN        /* User didn't enter a time */
000012     SAY "O.K. Game's over."
000013 ELSE
000014     DO
000015         SAY "The computer says:"
000016         /* TSO system */ TIME /* command */
000017     END
000018
000019 EXIT
***** ***** BOTTOM OF DATA *****

```

Keyword

A keyword instruction tells the language processor to do something. It begins with a REXX keyword that identifies what the language processor is to do. For example, SAY (line 7) displays a string on the screen and PULL (line 8) takes one or more words of input and puts them into the variable `usertime`.

IF, THEN (line 11) and ELSE (line 13) are three keywords that work together in one instruction. Each keyword forms a clause, which is a subset of an instruction. If the expression that follows the IF keyword is true, the instruction that follows the THEN keyword is processed. Otherwise, the instruction that follows the ELSE keyword is processed. If more than one instruction follows a THEN or an ELSE, the instructions are preceded by a DO (line 14) and followed by an END (line 17). More information about the IF/THEN/ELSE instruction appears in “Using Conditional Instructions” on page 42.

The EXIT keyword (line 19) tells the language processor to end the exec. Using EXIT in the preceding example is a convention, not a necessity, because processing ends automatically when there are no more instructions in the exec. More about EXIT appears in “EXIT Instruction” on page 57.

Assignment

An assignment gives a value to a variable or changes the current value of a variable. A simple assignment instruction is:

```
number = 4
```

In addition to giving a variable a straightforward value, an assignment instruction can also give a variable the result of an expression. An expression is something that needs to be calculated, such as an arithmetic expression. The expression can contain numbers, variables, or both.

```
number = 4 + 4
```

```
number = number + 4
```

Syntax of REXX Instructions

In the first of the two examples, the value of number is 8. If the second example directly followed the first in an exec, the value of number would become 12. More about expressions is covered in “Using Expressions” on page 28.

Label

A label, such as Game1: (line 5), is a symbolic name followed by a colon. A label can contain either single- or double-byte characters or a combination of single- and double-byte characters. (Double-byte characters are valid only if you have included OPTIONS ETMODE as the first instruction in your exec.) A label identifies a portion of the exec and is commonly used in subroutines and functions, and with the SIGNAL instruction. More about the use of labels appears in “Chapter 6. Writing Subroutines and Functions” on page 69 and “SIGNAL Instruction” on page 58.

Null

A null is a comment or a blank line, which is ignored by the language processor but make an exec easier to read.

- Comments (lines 1 through 4, 8 through 11, 16)

A comment begins with /* and ends with */. Comments can be on one or more lines or on part of a line. You can put information in a comment that might not be obvious to a person reading the REXX instructions. Comments at the beginning can describe the overall purpose of the exec and perhaps list special considerations. A comment next to an individual instruction can clarify its purpose.

Note: To prevent incompatibilities with CLISTs, IBM recommends that all REXX execs start with a comment that includes the characters “REXX” within the first line (line 1) of the exec. Failure to do so can lead to unexpected or unintended results in your REXX exec. This type of comment is called the REXX exec identifier and immediately identifies the program to readers as a REXX exec and also distinguishes it from a CLIST. It is necessary to distinguish execs from CLISTs when they are both stored in the system file, SYSPROC. For more information about where and how execs are stored, see “Running an Exec Implicitly” on page 17.

- Blank lines (lines 6, 18)

Blank lines help separate groups of instructions and aid readability. The more readable an exec, the easier it is to understand and maintain.

Command

An instruction that is not a keyword instruction, assignment, label, or null is processed as a command and is sent to a previously defined environment for processing. For example, the word "TIME" in the previous exec (line 16), even though surrounded by comments, is processed as a TSO/E command.

```
/* TSO system */ TIME /* command */
```

More information about issuing commands appears in “Chapter 8. Entering Commands from an Exec” on page 97.

Execs Using Double-Byte Character Set Names

You can use double-byte character set (DBCS) names in your REXX execs for literal strings, labels, variable names, and comments. Such character strings can be single-byte, double-byte, or a combination of both single- and double-byte names. To use DBCS names, you must code OPTIONS ETMODE as the first instruction in the exec. ETMODE specifies that those strings that contain DBCS characters are to

Execs Using Double-Byte Character Set Names

be checked as being valid DBCS strings. DBCS characters must be enclosed within shift-out (X'0E') and shift-in (X'0F') delimiters. In the following example, the shift-out (SO) and shift-in (SI) delimiters are represented by the less than symbol (<) and the greater than symbol (>) respectively.¹ For example, <.S.Y.M.D> and <.D.B.C.S.R.T.N> represent DBCS symbols in the following examples.

Example 1

The following is an example of an exec using a DBCS variable name and a DBCS subroutine label.

```
/* REXX */
OPTIONS 'ETMODE'          /* ETMODE to enable DBCS variable names */
j = 1
<.S.Y.M.D> = 10          /* Variable with DBCS characters between
                          shift-out (<) and shift-in (>) */
CALL <.D.B.C.S.R.T.N>    /* Invoke subroutine with DBCS name */
:
:

<.D.B.C.S.R.T.N>:      /* Subroutine with DBCS name */
DO i = 1 TO 10
  IF x.i = <.S.Y.D.M> THEN /* Does x.i match the DBCS variable's
                          value? */
    SAY 'Value of the DBCS variable is : ' <.S.Y.D.M>
END
EXIT 0
```

Example 2

The following example shows some other uses of DBCS variable names with the EXECIO stem option, as DBCS parameters passed to a program invoked through LINKMVS, and with built-in function, LENGTH.

```
/* REXX */
OPTIONS 'ETMODE'          /* ETMODE to enable DBCS variable names */

"ALLOC FI(INDD) DA('DEPTA29.DATA') SHR REU"

/*****
/* Use EXECIO to read lines into DBCS stem variables */
*****/

"EXECIO * DISKR indd (FINIS STEM <.d.b.c.s__s.t.e.m>."

IF rc = 0 THEN          /* if good return code from execio */

  /*****
  /* Say each DBCS stem variable set by EXECIO */
  *****/

  DO i = 1 TO <.d.b.c.s__s.t.e.m>.0

    SAY "Line " i " ==> " <.d.b.c.s__s.t.e.m>.i

  END

line1_<.v.a.l.u.e> = <.d.b.c.s__s.t.e.m>.1 /* line 1 value */

line_len = length(line1_<.v.a.l.u.e>) /* Length of line */

/*****
/* Invoke LINKMVS command "proca29" to process a line. */
*****/
```

1. The SO and SI characters are non-printable.

Execs Using Double-Byte Character Set Names

```
/* Two variable names are used to pass 2 parameters, one of */
/* which is a DBCS variable name. The LINKMVS host command */
/* environment routine will look up the value of the two */
/* variables and pass their values to the address LINKMVS */
/* command, "proca29". */
/*******/
ADDRESS LINKMVS "proca29 line_len line1_<.v.a.l.u.e>"
"FREE FI(INDD)"
EXIT 0
```

Running an Exec

After you have placed REXX instructions in a data set, you can run the exec *explicitly* by using the EXEC command followed by the data set name and the "exec" keyword operand, or *implicitly* by entering the member name. You can run an exec implicitly only if the PDS that contains it was allocated to a system file. More information about system files appears in the "Running an Exec Implicitly" on page 17.

Running an Exec Explicitly

The EXEC command runs non-compiled programs in TSO/E. To run an exec explicitly, enter the EXEC command followed by the data set name that contains the exec and the keyword operand "exec" to distinguish it from a CLIST.

You can specify a data set name according to the TSO/E data set naming conventions in several different ways. For example the data set name USERID.REXX.EXEC(TIMEGAME) can be specified as:

- A **fully-qualified data set**, which appears within quotation marks.
EXEC 'userid.rexx.exec(timegame)' exec
- A **non fully-qualified data set**, which has no quotation marks can eliminate your profile prefix (usually your user ID) as well as the third qualifier, exec.
EXEC rexx.exec(timegame) exec /* eliminates prefix */
EXEC rexx(timegame) exec /* eliminates prefix and exec */

For information about other ways to specify a data set name, see the EXEC command in *z/OS TSO/E Command Reference*.

You can type the EXEC command in the following places:

- At the READY prompt
READY
EXEC rexx.exec(timegame) exec
- From the COMMAND option of ISPF/PDF

```
----- TSO COMMAND PROCESSOR -----
ENTER TSO COMMAND OR CLIST BELOW:

====> exec rexx.exec(timegame) exec

ENTER SESSION MANAGER MODE ====> NO (YES or NO)
```

- On the COMMAND line of any ISPF/PDF panel as long as the EXEC command is preceded by the word "tso".

```

----- EDIT - ENTRY PANEL -----
COMMAND ==> tso exec rexx.exec(timegame) exec

ISPF LIBRARY:
PROJECT ==> PREFIX
GROUP   ==> REXX   ==>           ==>           ==>
TYPE    ==> EXEC
MEMBER  ==> TIMEGAME      (Blank for member selection list)

OTHER PARTITIONED OR SEQUENTIAL DATA SET:
DATA SET NAME   ==>
VOLUME SERIAL   ==>      (If not cataloged)

DATA SET PASSWORD ==>      (If password protected)

PROFILE NAME     ==>      (Blank defaults to data set type)

INITIAL MACRO    ==>      LOCK      ==> YES  (YES, NO or NEVER)

FORMAT NAME      ==>      MIXED MODE ==> NO  (YES or NO)
  
```

Running an Exec Implicitly

Running an exec implicitly means running an exec by simply entering the member name of the data set that contains the exec. Before you can run an exec implicitly, you must allocate the PDS that contains it to a system file (SYSPROC or SYSEXEC).

SYSPROC is a system file whose data sets can contain both CLISTs and execs. (Execs are distinguished from CLISTs by the REXX exec identifier, a comment at the beginning of the exec the first line of which includes the word "REXX".) SYSEXEC is a system file whose data sets can contain only execs. (Your installation might have changed the name to something other than SYSEXEC, but for the purposes of this book, we will call it SYSEXEC.) When both system files are available, SYSEXEC is searched before SYSPROC.

Allocating a PDS to a System File

To allocate the PDS that contains your execs to a system file, you need to do the following:

- Decide if you want to use the separate file for execs (SYSEXEC) or combine CLISTs and execs in the same file (SYSPROC). For information that will help you decide, see “Things to Consider When Allocating to a System File (SYSPROC or SYSEXEC)” on page 174.
- Use one of the following two checklists for a step-by-step guide to writing an exec that allocates a PDS to a system file.
 - “Checklist #3: Writing an Exec that Sets up Allocation to SYSEXEC” on page 191
 - “Checklist #4: Writing an Exec that Sets up Allocation to SYSPROC” on page 192

After your PDS is allocated to the system file, you can then run an exec by simply typing the name of the data set member that contains the exec. You can type the member name in any of the following locations:

- At the READY prompt

```

READY
  timegame
      
```
- From the COMMAND option of ISPF/PDF

Running an Exec

```
----- TSO COMMAND PROCESSOR -----  
ENTER TSO COMMAND OR CLIST BELOW:  
  
====> timegame  
  
ENTER SESSION MANAGER MODE ====> NO (YES or NO)
```

- On the COMMAND line of any ISPF/PDF panel as long as the member name is preceded by "tso".

```
----- EDIT - ENTRY PANEL -----  
COMMAND ====> tso timegame  
  
ISPF LIBRARY:  
PROJECT ====> PREFIX  
GROUP   ====> REXX   ====>           ====>  
TYPE    ====> EXEC  
MEMBER  ====> TIMEGAME (Blank for member selection list)  
  
OTHER PARTITIONED OR SEQUENTIAL DATA SET:  
DATA SET NAME   ====>  
VOLUME SERIAL  ====> (If not cataloged)  
  
DATA SET PASSWORD ====> (If password protected)  
  
PROFILE NAME    ====> (Blank defaults to data set type)  
  
INITIAL MACRO   ====> LOCK   ====> YES (YES, NO or NEVER)  
  
FORMAT NAME     ====> MIXED MODE ====> NO (YES or NO)
```

To reduce the search time for an exec that is executed implicitly and to differentiate it from a TSO/E command, precede the member name with a %:

```
READY  
%timegame
```

When a member name is preceded by %, TSO/E searches a limited number of system files for the name, thus reducing the search time. Without the %, TSO/E searches several files before it searches SYSEXEC and SYSPROC to ensure that the name you entered is not a TSO/E command.

Exercises - Running the Example Execs

Create a PDS exec library using Checklist #1 or Checklist #2 in “Appendix A. Allocating Data Sets” on page 185. Then try the example execs from the beginning of this chapter. Run them explicitly with the EXEC command and see if the results you get are the same as the ones in this book. If they are not, why aren’t they the same?

Now write an exec to allocate your PDS to SYSPROC or SYSEXEC using Checklist #3 on page 191 or Checklist #4 on page 192. Then run the example execs implicitly. Which way is easier?

Interpreting Error Messages

When you run an exec that contains an error, an error message often displays the line on which the error occurred and gives an explanation of the error. Error messages can result from syntax errors and from computational errors. For example, the following exec has a syntax error.

Example of an Exec with a Syntax Error

```

/***** REXX *****/
/* This is an interactive REXX exec that asks the user for a */
/* name and then greets the user with the name supplied. It */
/* contains a deliberate error. */
/*****/

SAY "Hello! What's your name?"
PULL who /* Get the person's name.
IF who = '' THEN
  SAY 'Hello stranger'
ELSE
  SAY 'Hello' who

```

When the exec runs, you see the following on your screen:

```

Hello! What's your name?
 7 +++ PULL who /* Get the person's name.
IF who =
'' THEN SAY 'Hello stranger'ELSE SAY 'Hello' who
IRX0006I Error running REXX.EXEC(HELLO), line 7: Unmatched "/" or quote
***

```

The exec runs until it detects the error, a missing `*/` at the end of the comment. As a result, the `SAY` instruction displays the question, but doesn't wait for your response because the next line of the exec contains the syntax error. The exec ends and the language processor displays error messages.

The first error message begins with the line number of the statement where the error was detected, followed by three pluses (+++) and the contents of the statement.

```

 7 +++ PULL who /* Get the person's name.
IF who =
'' THEN SAY 'Hello stranger'ELSE SAY 'Hello' who

```

The second error message begins with the message number followed by a message containing the exec name, line where the error was found, and an explanation of the error.

```

IRX0006I Error running REXX.EXEC(HELLO), line 7: Unmatched "/" or quote

```

For more information about the error, you can go to the message explanations in *z/OS TSO/E Messages*, where information is arranged by message number.

To fix the syntax error in this exec, add `*/` to the end of the comment on line 7.

```

PULL who /* Get the person's name.*/

```

Preventing Translation to Uppercase

As a rule, all alphabetic characters processed by the language processor are translated to uppercase before they are processed. These alphabetic characters can be from within an exec, such as words in a REXX instruction, or they can be external to an exec and processed as input. You can prevent this translation to uppercase in two ways depending on whether the characters are read as parts of instructions from within an exec or are read as input to an exec.

From Within an Exec

To prevent translation of alphabetic characters to uppercase from within an exec, simply enclose the characters in single or double quotation marks. Numbers and special characters, whether or not in quotation marks, are not changed by the language processor. For example, when you follow a SAY instruction with a phrase containing a mixture of alphabetic characters, numbers, and special characters, only the alphabetic characters are changed.

```
SAY The bill for lunch comes to $123.51!
```

results in:

```
THE BILL FOR LUNCH COMES TO $123.51!
```

Quotation marks ensure that information from within an exec is processed exactly as typed. This is important in the following situations:

- For output when it must be lowercase or a mixture of uppercase and lowercase.
- To ensure that commands are processed correctly. For example, if a variable name in an exec is the same as a command name, the exec ends in error when the command is issued. It is good programming practice to avoid using variable names that are the same as commands, but just to be safe, enclose all commands in quotation marks.

As Input to an Exec

When reading input from a terminal or when passing input from another exec, the language processor also changes alphabetic characters to uppercase before they are processed. To prevent translation to uppercase, use the PARSE instruction.

For example, the following exec reads input from the terminal screen and re-displays the input as output.

Example of Reading and Re-displaying Input

```
/****** REXX *****/
/* This is an interactive REXX exec that asks a user for the name */
/* of an animal and then re-displays the name. */
/*******/

SAY "Please type in the name of an animal."
PULL animal /* Get the animal name.*/
SAY animal
```

If you responded to the example with the word **tyrannosaurus**, you would see on your screen:

```
TYRANNOSAURUS
```

To cause the language processor to read input exactly as it is presented, use the PARSE PULL instruction.

```
PARSE PULL animal
```

Then if you responded to the example with **TyRannOsauRus**, you would see on the screen:

```
TyRannOsauRus
```

Exercises - Running and Modifying the Example Execs

Write and run the preceding Example of Reading and Re-displaying Input. Try various input and observe the output. Now change the PULL instruction to a PARSE PULL instruction and observe the difference.

Passing Information to an Exec

When an exec runs, you can pass information to it in several ways, two of which are:

- Through terminal interaction
- By specifying input when invoking the exec.

Using Terminal Interaction

The PULL instruction is one way for an exec to receive input as shown by a previous example repeated here.

Example of an Exec that Uses PULL

```
/****** REXX ******/
/* This exec adds two numbers and displays their sum. */
/*******/
SAY 'Please enter a number.'
PULL number1
SAY 'Now enter a number to add to the first number.'
PULL number2
sum = number1 + number2
SAY 'The sum of the two numbers is' sum'.'
```

The PULL instruction can extract more than one value at a time from the terminal by separating a line of input, as shown in the following variation of the previous example.

Variation of an Example that Uses PULL

```
/****** REXX ******/
/* This exec adds two numbers and displays their sum. */
/*******/
SAY 'Please enter two numbers.'
PULL number1 number2
sum = number1 + number2
SAY 'The sum of the two numbers is' sum'.'
```

Passing Information to an Exec

Note: For the PULL instruction to extract information from the terminal, the data stack must be empty. More information about the data stack appears in “Chapter 11. Storing Information in the Data Stack” on page 135.

Specifying Values when Invoking an Exec

Another way for an exec to receive input is through values specified when you invoke the exec. For example to pass two numbers to an exec named "add", using the EXEC command, type:

```
EXEC rexx.exec(add) '42 21' exec
```

To pass input when running an exec implicitly, simply type values (words or numbers) after the member name.

```
add 42 21
```

These values are called an *argument*. For information about arguments, see “Passing Arguments” on page 24.

The exec "add" uses the ARG instruction to assign the input to variables as shown in the following example.

Example of an Exec that Uses the ARG Instruction

```
/****** REXX ******/
/* This exec receives two numbers as input, adds them, and */
/* displays their sum. */
/*******/
ARG number1 number2
sum = number1 + number2
SAY 'The sum of the two numbers is' sum'.'
```

ARG assigns the first number, 42, to number1 and the second number, 21, to number2.

If the number of values is fewer or more than the number of variable names after the PULL or the ARG instruction, errors can occur as described in the following sections.

Specifying Too Few Values

When you specify fewer values than the number of variables following the PULL or ARG instruction, the extra variables are set to null. For example, you pass only one number to "add".

```
EXEC rexx.exec(add) '42' exec
```

The first variable following the ARG instruction, number1, is assigned the value 42. The second variable, number2, is set to null. In this situation, the exec ends with an error when it tries to add the two variables. In other situations, the exec might not end in error.

Specifying Too Many Values

When you specify more values than the number of variables following the PULL or ARG instruction, the last variable gets the remaining values. For example, you pass three numbers to "add".

```
EXEC rexx.exec(add) '42 21 10' exec
```

The first variable following the ARG instruction, number1, is assigned the value 42. The second variable gets both '21 10'. In this situation, the exec ends with an error when it tries to add the two variables. In other situations, the exec might not end in error.

To prevent the last variable from getting the remaining values, use a period (.) at the end of the PULL or ARG instruction.

```
ARG number1 number2 .
```

The period acts as a "dummy variable" to collect unwanted extra information. If there is no extra information, the period is ignored. You can also use a period as a place holder within the PULL or ARG instruction as follows:

```
ARG . number1 number2
```

In this case, the first value, 42, is discarded and number1 and number2 get the next two values, 21 and 10.

Preventing Translation of Input to Uppercase

Like the PULL instruction, the ARG instruction changes alphabetic characters to uppercase. To prevent translation to uppercase, precede ARG with PARSE as demonstrated in the following example.

```
Example of an Exec that Uses PARSE ARG
/***** REXX *****/
/* This exec receives the last name, first name, and score of */
/* a student and displays a sentence reporting the name and */
/* score. */
/*****
PARSE ARG lastname firstname score
SAY firstname lastname 'received a score of' score'.
```

Exercises - Using the ARG Instruction

The left column shows the input values sent to an exec. The right column is the ARG statement within the exec that receives the input. What value does each variable assume?

Input	Variables Receiving Input
1. 115 -23 66 5.8	ARG first second third
2. .2 0 569 2E6	ARG first second third fourth
3. 13 13 13 13	ARG first second third fourth fifth
4. Weber Joe 91	ARG lastname firstname score
5. Baker Amanda Marie 95	PARSE ARG lastname firstname score
6. Callahan Eunice 88 62	PARSE ARG lastname firstname score

ANSWERS

1. first = 115, second = -23, third = 66 5.8
2. first = .2, second = 0, third = 569, fourth = 2E6

Passing Information to an Exec

3. first = 13, second = 13, third = 13, fourth = 13, fifth = *null*
4. lastname = WEBER, firstname = JOE, score = 91
5. lastname = Baker, firstname = Amanda, score = Marie 95
6. lastname = Callahan, firstname = Eunice, score = 88

Passing Arguments

Values passed to an exec are usually called arguments. Arguments can consist of one word or a string of words. Words within an argument are separated by blanks. The number of arguments passed depends on how the exec is invoked.

Passing Arguments Using the CALL Instruction or REXX Function Call

When you invoke a REXX exec using either the CALL instruction or a REXX function call, you can pass up to 20 arguments to an exec. Each argument must be separated by a comma.

Passing Arguments Using the EXEC Command

When you invoke a REXX exec either implicitly or explicitly using the EXEC command, you can pass either one or no arguments to the exec. Thus the ARG instruction in the preceding examples received only one argument. One argument can consist of many words. The argument, if present, will appear as a single string.

If you plan to use commas within the argument string when invoking a REXX exec using the EXEC command, special consideration must be given. For example, if you specify:

```
GETARG 1,2
```

or

```
ex 'sam.rexx.exec(getarg)' '1,2'
```

the exec receives a single argument string consisting of "1,2". The exec could then use a PARSE ARG instruction to break the argument string into the comma-separated values like the following:

```
PARSE ARG A ',' B
SAY 'A is ' A /* Will say 'A is 1' */
SAY 'B is ' B /* Will say 'B is 2' */
```

However, because commas are treated as separator characters in TSO/E, you cannot pass an argument string that contains a leading comma using the implicit form of the EXEC command. That is, if you invoke the exec using:

```
GETARG ,2
```

the exec is invoked with an argument string consisting of "2". The leading comma separator is removed before the exec receives control. If you need to pass an argument string separated by commas and the leading argument is null (that is, contains a leading comma), you must use the explicit form of the EXEC command. For example:

```
ex 'sam.rexx.exec(getarg)' ',2'
```

In this case, the exec is invoked with an argument string consisting of ",2".

For more information about functions and subroutines, see "Chapter 6. Writing Subroutines and Functions" on page 69. For more information about arguments, see "Parsing Multiple Strings as Arguments" on page 92.

Chapter 3. Using Variables and Expressions

Using Variables	25
Variable Names	26
Variable Values	27
Exercises - Identifying Valid Variable Names	27
Using Expressions	28
Arithmetic Operators	28
Division	29
Order of Evaluation	29
Using Arithmetic Expressions.	30
Exercises - Calculating Arithmetic Expressions	30
Comparison Operators	30
The Strictly Equal and Equal Operators	31
Using Comparison Expressions	31
Exercises - Using Comparison Expressions	32
Logical (Boolean) Operators	32
Using Logical Expressions.	33
Exercises - Using Logical Expressions	34
Concatenation Operators	34
Using Concatenation Operators	34
Priority of Operators	35
Exercises - Priority of Operators	36
Tracing Expressions with the TRACE Instruction	37
Tracing Operations	37
Tracing Results.	38
Exercises - Using the TRACE Instruction	38

This chapter describes variables, expressions, and operators, and explains how to use them in REXX execs.

One of the most powerful aspects of computer programming is the ability to process variable data to achieve a result. The variable data could be as simple as two numbers, the process could be subtraction, and the result could be the answer.

```
answer = number1 - number2
```

Or the variable data could be input to a series of complex mathematical computations that result in a 3-dimensional animated figure.

Regardless of the complexity of a process, the premise is the same. When data is unknown or if it varies, you substitute a symbol for the data, much like the "x" and "y" in an algebraic equation.

```
x = y + 29
```

The symbol, when its value can vary, is called a *variable*. A group of symbols or numbers that must be calculated to be resolved is called an *expression*.

Using Variables

A variable is a character or group of characters that represents a value. A variable can contain either single- or double-byte characters, or a combination of single- and double-byte characters. (Double-byte characters are valid only if you include OPTIONS ETMODE as the first instruction of your exec.) The following variable big represents the value one million or 1,000,000.

Using Variables

```
big = 1000000
```

Variables can refer to different values at different times. If you assign a different value to `big`, it gets the value of the new assignment, until it is changed again.

```
big = 999999999
```

Variables can also represent a value that is unknown when the exec is written. In the following example, the user's name is unknown, so it is represented by the variable `who`.

```
SAY "Hello! What's your name?"
```

```
PARSE PULL who /* Put the person's name in the variable "who" */
```

Variable Names

A variable name, the part that represents the value, is always on the left of the assignment statement and the value itself is on the right. In the following example, the word "variable1" is the variable name:

```
variable1 = 5  
SAY variable1
```

As a result of the above assignment statement, `variable1` is assigned the value "5", and you see on the terminal screen:

```
5
```

Variable names can consist of:

A...Z	uppercase alphabetic
a...z	lowercase alphabetic
0...9	numbers
@ # \$ % ? ! . _	special characters
X'41' ... X'FE'	double-byte character set (DBCS) characters. (ETMODE must be on for these characters to be valid in a variable name.)

Restrictions on the variable name are:

- The first character cannot be 0 through 9 or a period (.)
- The variable name cannot exceed 250 bytes. For names containing DBCS characters, count each DBCS character as two bytes, and count the shift-out (SO) and shift-in (SI) as one byte each.
- DBCS characters within a DBCS name must be delimited by SO (X'0E') and SI (X'0F'). Also note that:
 - SO and SI cannot be contiguous.
 - Nesting of SO / SI is not permitted.
 - A DBCS name cannot contain a DBCS blank (X'4040').
- The variable name should not be RC, SIGL, or RESULT, which are REXX special variables. More about special variables appears later in this book.

Examples of acceptable variable names are:

```
ANSWER ?98B X Word3 number the_ultimate_value
```

Also, if ETMODE is set on, the following are valid DBCS variable names, where < represents shift-out, and > represents shift-in, '.X', '.Y', and '.Z' represent DBCS characters, and lowercase letters and numbers represent themselves.

```
<.X.Y.Z>  number_<.X.Y.Z>  <.X.Y>1234<.Z>
```

Variable Values

The value of the variable, which is the value the variable name represents, might be categorized as follows:

- A **constant**, which is a number that is expressed as:
 - An integer (12)
 - A decimal (12.5)
 - A floating point number (1.25E2)
 - A signed number (-12)
 - A string constant (' 12')
- A **string**, which is one or more words that may or may not be enclosed in quotation marks, such as:

```
This value is a string.
'This value is a literal string.'
```

- The **value from another variable**, such as:

```
variable1 = variable2
```

In the above example, variable1 changes to the value of variable2, but variable2 remains the same.

- An **expression**, which is something that needs to be calculated, such as:

```
variable2 = 12 + 12 - .6          /* variable2 becomes 23.4 */
```

Before a variable is assigned a value, the variable displays the value of its own name translated to uppercase. In the following example, if the variable new was not assigned a previous value, the word "NEW" is displayed.

```
SAY new                          /* displays NEW */
```

Exercises - Identifying Valid Variable Names

Which of the following are valid REXX variable names?

1. 8eight
2. \$25.00
3. MixedCase
4. nine_to_five
5. result

ANSWERS

1. Invalid, because the first character is a number
2. Valid
3. Valid
4. Valid
5. Valid, but it is a reserved variable name and we recommend that you use it only to receive results from a subroutine

Using Expressions

An expression is something that needs to be calculated and consists of numbers, variables, or strings, and one or more operators. The operators determine the kind of calculation to be done on the numbers, variables, and strings. There are four types of operators: arithmetic, comparison, logical, and concatenation.

Arithmetic Operators

Arithmetic operators work on valid numeric constants or on variables that represent valid numeric constants.

Types of Numeric Constants

- 12** A **whole number** has no decimal point or commas. Results of arithmetic operations with whole numbers can contain a maximum of nine digits unless you override the default with the NUMERIC DIGITS instruction. For information about the NUMERIC DIGITS instruction, see *z/OS TSO/E REXX Reference*. Examples of whole numbers are: 123456789 0 91221 999
- 12.5** A **decimal number** includes a decimal point. Results of arithmetic operations with decimal numbers are limited to a total maximum of nine digits (NUMERIC DIGITS default) before **and** after the decimal. Examples of decimal numbers are: 123456.789 0.888888888
- 1.25E2** A **floating point number** in exponential notation, is sometimes called scientific notation. The number after the "E" represents the number of places the decimal point moves. Thus 1.25E2 (also written as 1.25E+2) moves the decimal point to the right two places and results in 125. When an "E" is followed by a minus (-), the decimal point moves to the left. For example, 1.25E-2 is .0125.

Floating point numbers are used to represent very large or very small numbers. For more information about floating point numbers, see *z/OS TSO/E REXX Reference*.
- 12** A **signed number** with a minus (-) next to the number represents a negative value. A plus next to a number indicates that the number should be processed as it is written. When a number has no sign, it is processed as a positive value.

The arithmetic operators you can use are as follows:

Operator	Meaning
+	Add
-	Subtract
*	Multiply
/	Divide
%	Divide and return a whole number without a remainder
//	Divide and return the remainder only
**	Raise a number to a whole number power
- <i>number</i>	Negate the number
+ <i>number</i>	Add the number to 0

Using numeric constants and arithmetic operators, you can write arithmetic expressions as follows:

```
7 + 2           /* result is 9   */
7 - 2           /* result is 5   */
7 * 2           /* result is 14  */
7 ** 2          /* result is 49   */
7 ** 2.5        /* result is an error */
```

Division

Notice that three operators represent division. Each operator displays the result of a division expression in a different way.

/ Divide and express the answer possibly as a decimal number. For example:

```
7 / 2           /* result is 3.5 */
6 / 2           /* result is 3   */
```

% Divide and express the answer as a whole number. The remainder is ignored. For example:

```
7 % 2           /* result is 3   */
```

// Divide and express the answer as the remainder only. For example:

```
7 // 2          /* result is 1   */
```

Order of Evaluation

When you have more than one operator in an arithmetic expression, the order of numbers and operators can be critical. For example, in the following expression, which operation does the language processor perform first?

```
7 + 2 * (9 / 3) - 1
```

Proceeding from left to right, it is evaluated as follows:

- Expressions within parentheses are evaluated first.
- Expressions with operators of higher priority are evaluated before expressions with operators of lower priority.

Arithmetic operator priority is as follows, with the highest first:

Arithmetic Operator Priority

- +	Prefix operators
**	Power (exponential)
* / % //	Multiplication and division
+ -	Addition and subtraction

Thus the preceding example would be evaluated in the following order:

1. Expression in parentheses

```
7 + 2 * (9 / 3) - 1
           \____/
            3
```

2. Multiplication

```
7 + 2 * 3 - 1
     \____/
      6
```

3. Addition and subtraction from left to right

```
7 + 6 - 1 = 12
```

Using Expressions

Using Arithmetic Expressions

You can use arithmetic expressions in an exec many different ways. The following example uses several arithmetic operators to round and remove extra decimal places from a dollar and cents value.

Example Using Arithmetic Expressions

```
/****** REXX ******/
/* This exec computes the total price of an item including sales tax
/* rounded to two decimal places. The cost and percent of the tax
/* (expressed as a decimal number) are passed to the exec when it
/* is run. */
/*******/

PARSE ARG cost percent_tax

total = cost + (cost * percent_tax) /* Add tax to cost. */
price = ((total * 100 + .5) % 1) / 100 /* Round and remove
/* extra decimal places.*/

SAY 'Your total cost is $'price'.'
```

Exercises - Calculating Arithmetic Expressions

1. What will the following program display on the screen?

Exercise

```
/****** REXX ******/
pa = 1
ma = 1
kids = 3
SAY "There are" pa + ma + kids "people in this family."
```

2. What is the value of:
 - a. $6 - 4 + 1$
 - b. $6 - (4 + 1)$
 - c. $6 * 4 + 2$
 - d. $6 * (4 + 2)$
 - e. $24 \% 5 / 2$

ANSWERS

1. There are 5 people in this family.
2. The values are as follows:
 - a. 3
 - b. 1
 - c. 26
 - d. 36
 - e. 2

Comparison Operators

Expressions that use comparison operators do not return a number value as do arithmetic expressions. Comparison expressions return either a true or false response in terms of 1 or 0 as follows:

- 1 True
- 0 False

Using Expressions

Comparison operators can compare numbers or strings and ask questions, such as:

Are the terms equal? (A = B)

Is the first term greater than the second? (A > B)

Is the first term less than the second? (A < B)

For example, if A = 4 and B = 3, then the results of the previous comparison questions are:

(A = B) Does 4 = 3? **0** (False)

(A > B) Is 4 > 3? **1** (True)

(A < B) Is 4 < 3? **0** (False)

The more commonly used comparison operators are as follows:

Operator	Meaning
<code>==</code>	Strictly Equal
<code>=</code>	Equal
<code>\==</code>	Not strictly equal
<code>\=</code>	Not equal
<code>></code>	Greater than
<code><</code>	Less than
<code>> <</code>	Greater than or less than (same as not equal)
<code>> =</code>	Greater than or equal to
<code>\<</code>	Not less than
<code>< =</code>	Less than or equal to
<code>\></code>	Not greater than

Note: The not character, "-", is synonymous with the backslash ("\"). The two characters may be used interchangeably according to availability and personal preference. This book uses the backslash ("\") character.

The Strictly Equal and Equal Operators

When two expressions are **strictly equal**, everything including the blanks and case (when the expressions are characters) is exactly the same.

When two expressions are **equal**, they are resolved to be the same. The following expressions are all true.

```
'WORD' = word                   /* returns 1 */
'word ' \== word               /* returns 1 */
'word' == 'word'               /* returns 1 */
4e2 \== 400                     /* returns 1 */
4e2 \= 100                      /* returns 1 */
```

Using Comparison Expressions

Often a comparison expression is used in IF/THEN/ELSE instructions. The following example uses an IF/THEN/ELSE instruction to compare two values. For more information about this instruction, see "IF/THEN/ELSE Instructions" on page 42.

Using Expressions

Example Using A Comparison Expression

```
/****** REXX ******/
/* This exec compares what you paid for lunch for two */
/* days in a row and then comments on the comparison. */
/*******/
SAY 'What did you spend for lunch yesterday?'
SAY 'Please do not include the dollar sign.'

PARSE PULL last

SAY 'What did you spend for lunch today?'
SAY 'Please do not include the dollar sign.'

PARSE PULL lunch

IF lunch > last THEN /* lunch cost increased */
    SAY "Today's lunch cost more than yesterday's."

ELSE /* lunch cost remained the same or decreased */
    SAY "Today's lunch cost the same or less than yesterday's."
```

Exercises - Using Comparison Expressions

1. In the preceding example of using a comparison expression, what appears on the screen when you respond to the prompts with the following lunch costs?

Yesterday's Lunch	Today's Lunch
4.42	3.75
3.50	3.50
3.75	4.42

2. What is the result (0 or 1) of the following expressions?
 - a. "Apples" = "Oranges"
 - b. " Apples" = "Apples"
 - c. " Apples" == "Apples"
 - d. 100 = 1E2
 - e. 100 \= 1E2
 - f. 100 \== 1E2

ANSWERS

1. The following sentences appear.
 - a. Today's lunch cost the same or less than yesterday's.
 - b. Today's lunch cost the same or less than yesterday's.
 - c. Today's lunch cost more than yesterday's.
2. The expressions result in the following. Remember 0 is false and 1 is true.
 - a. 0
 - b. 1
 - c. 0 (The first " Apples" has a space.)
 - d. 1
 - e. 0
 - f. 1

Logical (Boolean) Operators

Logical expressions, like comparison expressions, return a true (1) or false (0) value when processed. Logical operators combine two comparisons and return the true (1) or false (0) value depending on the results of the comparisons.

The logical operators are:

Operator	Meaning
&	<p>AND</p> <p>Returns 1 if both comparisons are true. For example:</p> <pre>(4 > 2) & (a = a) /* true, so result is 1 */</pre> <pre>(2 > 4) & (a = a) /* false, so result is 0 */</pre>
 	<p>Inclusive OR</p> <p>Returns 1 if at least one comparison is true. For example:</p> <pre>(4 > 2) (5 = 3) /* at least one is true, so result is 1 */</pre> <pre>(2 > 4) (5 = 3) /* neither one is true, so result is 0 */</pre>
&&	<p>Exclusive OR</p> <p>Returns 1 if only one comparison (but not both) is true. For example:</p> <pre>(4 > 2) && (5 = 3) /* only one is true, so result is 1 */</pre> <pre>(4 > 2) && (5 = 5) /* both are true, so result is 0 */</pre> <pre>(2 > 4) && (5 = 3) /* neither one is true, so result is 0 */</pre>
Prefix \	<p>Logical NOT</p> <p>Returns the opposite response. For example:</p> <pre>\ 0 /* opposite of 0, so result is 1 */</pre> <pre>\ (4 > 2) /* opposite of true, so result is 0 */</pre>

Using Logical Expressions

Logical expressions are used in complex conditional instructions and can act as checkpoints to screen unwanted conditions. When you have a series of logical expressions, for clarification, use one or more sets of parentheses to enclose each expression.

```
IF ((A < B) | (J < D)) & ((M = Q) | (M = D)) THEN ...
```

The following example uses logical operators to make a decision.

Example Using Logical Expressions

```

/***** REXX *****/
/* This exec receives arguments for a complex logical expression */
/* that determines whether a person should go skiing. The first */
/* argument is a season and the other two can be 'yes' or 'no'. */
/*****

PARSE ARG season snowing broken_leg

IF ((season = 'winter') | (snowing = 'yes')) & (broken_leg = 'no')
  THEN SAY 'Go skiing.'
ELSE
  SAY 'Stay home.'

```

When arguments passed to this example are "spring yes no", the IF clause translates as follows:

Using Expressions

```
IF ((season = 'winter') | (snowing = 'yes')) & (broken_leg = 'no') THEN
```

Diagram illustrating the evaluation of the logical expression: `((season = 'winter') | (snowing = 'yes')) & (broken_leg = 'no')`. The expression is broken down into three parts: `(season = 'winter')` (false), `(snowing = 'yes')` (true), and `(broken_leg = 'no')` (true). The first two parts are connected by a vertical bar (OR), resulting in true. This true result is then connected to the third part by an ampersand (AND), resulting in the final true result.

As a result, when you run the exec, you see the message:

```
Go skiing.
```

Exercises - Using Logical Expressions

A student applying to colleges has decided to pick ones according to the following specifications:

```
IF (inexpensive | scholarship) & (reputable | nearby) THEN
  SAY "I'll consider it."
ELSE
  SAY "Forget it!"
```

A college is inexpensive, did not offer a scholarship, is reputable, but is over 1000 miles away. Should the student apply?

ANSWER

Yes. The conditional instruction works out as follows:

```
IF (inexpensive | scholarship) & (reputable | nearby) THEN ...
```

Diagram illustrating the evaluation of the logical expression: `(inexpensive | scholarship) & (reputable | nearby)`. The expression is broken down into four parts: `inexpensive` (true), `scholarship` (false), `reputable` (true), and `nearby` (false). The first two parts are connected by a vertical bar (OR), resulting in true. The last two parts are also connected by a vertical bar (OR), resulting in true. These two true results are then connected by an ampersand (AND), resulting in the final true result.

Concatenation Operators

Concatenation operators combine two terms into one. The terms can be strings, variables, expressions, or constants. Concatenation can be significant in formatting output.

The operators that indicate how to join two terms are as follows:

Operator	Meaning
<i>blank</i>	Concatenate terms and place one blank in between. Terms that are separated by more than one blank default to one blank when read. For example: <pre>SAY true blue /* result is TRUE BLUE */</pre>
<i> </i>	Concatenate terms and place no blanks in between. For example: <pre>(8 / 2) (3 * 3) /* result is 49 */</pre>
<i>abuttal</i>	Concatenate terms and place no blanks in between. For example: <pre>per_cent'% ' /* if per_cent = 50, result is 50% */</pre>

Using Concatenation Operators

One way to format output is to use variables and concatenation operators as in the following example. A more sophisticated way to format information is with parsing and templates. Information about parsing appears in "Parsing Data" on page 87.

Example using Concatenation Operators

```

/***** REXX *****/
/* This exec formats data into columns for output. */
/*****/
sport = 'base'
equipment = 'ball'
column = '      '
cost = 5

SAY sport||equipment column '$' cost

```

The result of this example is:

```

baseball      $ 5

```

Priority of Operators

When more than one type of operator appears in an expression, what operation does the language processor do first?

```
IF (A > 7**B) & (B < 3) | (A||B = C) THEN ...
```

Like the priority of operators within the arithmetic operators, there is an overall priority that includes all operators. The priority of operators is as follows with the highest first.

Overall Operator Priority

<code>\ or ~ - +</code>	Prefix operators
<code>**</code>	Power (exponential)
<code>* / % //</code>	Multiply and divide
<code>+ -</code>	Add and subtract
<code>blank abuttal</code>	Concatenation operators
<code>== = >< etc.</code>	Comparison operators
<code>&</code>	Logical AND
<code> &&</code>	Inclusive OR and exclusive OR

Thus the previous example presented again below:

```
IF (A > 7**B) & (B < 3) | (A||B = C) THEN ...
```

given the following values:

```

A = 8
B = 2
C = 10

```

would be evaluated as follows:

1. Convert variables to values

```
IF (8 > 7**2) & (2 < 3) | (8||2 = 10) THEN ...
```
2. Compute operations of higher priority within parentheses

Using Expressions

- Exponential operation

IF (8 > 7**2) & (2 < 3) | (8||2 = 10) THEN ...

- Concatenation operation

IF (8 > 49) & (2 < 3) | (8||2 = 10) THEN ...

3. Compute all operations within parentheses from left to right

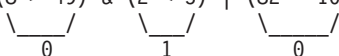
IF (8 > 49) & (2 < 3) | (82 = 10) THEN ...

4. Logical AND

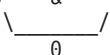
0 & 1 | 0

5. Inclusive OR

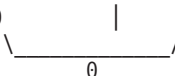
0 | 0

Exercises - Priority of Operators

1. What are the answers to the following examples?
 - a. 22 + (12 * 1)
 - b. -6 / -2 > (45 % 7 / 2) - 1
 - c. 10 * 2 - (5 + 1) // 5 * 2 + 15 - 1
2. In the example of the student and the college from “Exercises - Using Logical Expressions” on page 34, if the parentheses were removed from the student’s formula, what would be the outcome for the college?

```
IF inexpensive | scholarship & reputable | nearby THEN
  SAY "I'll consider it."
ELSE
  SAY "Forget it!"
```

Remember the college is inexpensive, did not offer a scholarship, is reputable, but is 1000 miles away.

ANSWERS

1. The results are as follows:
 - a. 34 (22 + 12 = 34)
 - b. 1 (true) (3 > 3 - 1)
 - c. 32 (20 - 2 + 15 - 1)
2. I’ll consider it.

The & operator has priority, as follows, but the outcome is the same as the previous version with the parentheses.

```
IF inexpensive | scholarship & reputable | nearby THEN
  true      false      true      false
  \         /         \         /
   \       /           \       /
    \     /             \     /
     \   /               \   /
      \ /                 \ /
       true                 true
        \                   /
         \                 /
          \               /
           \             /
            \           /
             \         /
              \       /
               \     /
                \   /
                 \ /
                  true
```

Tracing Expressions with the TRACE Instruction

You can use the TRACE instruction to display how the language processor evaluates each operation of an expression as it reads it, or to display the final result of an expression. These two types of tracing are useful for debugging execs.

Tracing Operations

To trace operations within an expression, use the TRACE I (TRACE Intermediates) form of the TRACE instruction. All expressions that follow the instruction are then broken down by operation and analyzed as:

- >V> - Variable value - The data traced is the contents of a variable.
- >L> - Literal value - The data traced is a literal (string, uninitialized variable, or constant).
- >O> - Operation result - The data traced is the result of an operation on two terms.

The following example uses the TRACE I instruction.

```

EDIT ---- USERID.REXX.EXEC(SAMPLE) ----- COLUMNS 009 080
COMMAND ==>                                SCROLL ==> HALF
***** ***** TOP OF DATA *****
000001 /***** REXX *****/
000002 /* This exec uses the TRACE instruction to show how an */
000003 /* expression is evaluated, operation by operation. */
000004 /***** */
000005 x = 9
000006 y = 2
000007 TRACE I
000008
000009 IF x + 1 > 5 * y THEN
000010     SAY 'x is big enough.'
000011 ELSE NOP                               /* No operation on the ELSE path */
***** ***** BOTTOM OF DATA *****

```

When you run the example, you see on your screen:

```

9 *-* IF x + 1 > 5 * y
>V>  "9"
>L>  "1"
>O>  "10"
>L>  "5"
>V>  "2"
>O>  "10"
>O>  "0"

```

First you see the line number (9 *-*) followed by the expression. Then the expression is broken down by operation as follows:

```

>V>  "9"      (value of variable x)
>L>  "1"      (value of literal 1)
>O>  "10"     (result of operation x + 1)
>L>  "5"      (value of literal 5)
>V>  "2"      (value of variable y)
>O>  "10"     (result of operation 5 * y)
>O>  "0"      (result of final operation 10 > 10 is false)

```

Tracing Expressions with the TRACE Instruction

Tracing Results

To trace only the final result of an expression, use the TRACE R (TRACE Results) form of the TRACE instruction. All expressions that follow the instruction are analyzed and the results are displayed as:

```
>>> Final result of an expression
```

If you changed the TRACE instruction operand in the previous example from an I to an R, you would see the following results.

```
9 *-* IF x + 1 > 5 * y
>>> "0"
```

In addition to tracing operations and results, the TRACE instruction offers other types of tracing. For information about the other types of tracing with the TRACE instruction, see *z/OS TSO/E REXX Reference*.

Exercises - Using the TRACE Instruction

Write an exec with a complex expression, such as:

```
IF (A > B) | (C < 2 * D) THEN ...
```

Define A, B, C, and D in the exec and use the TRACE I instruction.

ANSWER

Possible Solution

```
/****** REXX *****/
/* This exec uses the TRACE instruction to show how an expression */
/* is evaluated, operation by operation. */
/*******/
A = 1
B = 2
C = 3
D = 4

TRACE I

IF (A > B) | (C < 2 * D) THEN
  SAY 'At least one expression was true.'
ELSE
  SAY 'Neither expression was true.'
```

When this exec is run, you see the following:

Tracing Expressions with the TRACE Instruction

```
12 ** IF (A > B) | (C < 2 * D)
   >V> "1"
   >V> "2"
   >O> "0"
   >V> "3"
   >L> "2"
   >V> "4"
   >O> "8"
   >O> "1"
   >O> "1"
   ** THEN
13 ** SAY 'At least one expression was true.'
   >L> "At least one expression was true."
At least one expression was true.
```

Tracing Expressions with the TRACE Instruction

Chapter 4. Controlling the Flow Within an Exec

Using Conditional Instructions	42
IF/THEN/ELSE Instructions	42
Nested IF/THEN/ELSE Instructions	43
Exercise - Using the IF/THEN/ELSE Instruction	44
SELECT/WHEN/OTHERWISE/END Instruction	44
Exercises - Using the SELECT/WHEN/OTHERWISE/END Instruction	46
Using Looping Instructions	47
Repetitive Loops	47
Infinite Loops	48
DO FOREVER Loops	49
LEAVE Instruction	50
ITERATE Instruction	50
Exercises - Using Loops	51
Conditional Loops	52
DO WHILE Loops	52
Exercise - Using a DO WHILE Loop	53
DO UNTIL Loops	53
Exercise - Using a DO UNTIL Loop	54
Combining Types of Loops	55
Nested DO Loops	55
Exercises - Combining Loops	56
Using Interrupt Instructions	56
EXIT Instruction	57
CALL/RETURN Instructions	57
SIGNAL Instruction	58

This chapter introduces instructions that alter the sequential execution of an exec and demonstrates how those instructions are used.

Generally when an exec runs, one instruction after another executes, starting with the first and ending with the last. The language processor, unless told otherwise, executes instructions sequentially.

You can alter the order of execution within an exec by using specific REXX instructions that cause the language processor to skip some instructions, repeat others, or jump to another part of the exec. These specific REXX instructions can be classified as follows:

- Conditional instructions, which set up at least one condition in the form of an expression. If the condition is true, the language processor selects the path following that condition. Otherwise the language processor selects another path. The REXX conditional instructions are:
 - IF *expression*/THEN/ELSE
 - SELECT/WHEN *expression*/OTHERWISE/END.
- Looping instructions, which tell the language processor to repeat a set of instructions. A loop can repeat a specified number of times or it can use a condition to control repeating. REXX looping instructions are:
 - DO *expression*/END
 - DO FOREVER/END
 - DO WHILE *expression=true*/END
 - DO UNTIL *expression=true*/END

Controlling the Flow Within an Exec

- Interrupt instructions, which tell the language processor to leave the exec entirely or leave one part of the exec and go to another part, either permanently or temporarily. The REXX interrupt instructions are:

```
EXIT  
SIGNAL label  
CALL label//RETURN
```

Using Conditional Instructions

There are two types of conditional instructions. IF/THEN/ELSE can direct the execution of an exec to one of two choices. SELECT/WHEN/OTHERWISE/END can direct the execution to one of many choices.

IF/THEN/ELSE Instructions

The examples of IF/THEN/ELSE instructions in previous chapters demonstrated the two-choice selection. In a flow chart, this appears as follows:

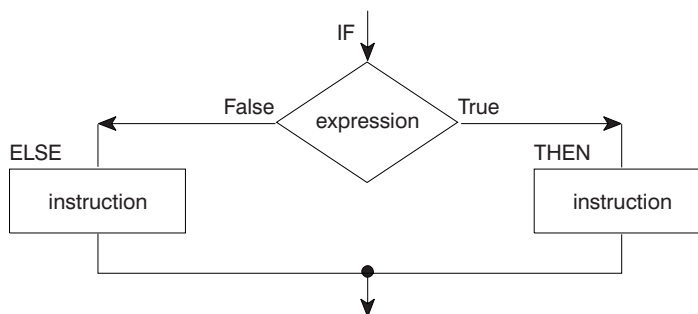

As a REXX instruction, the flowchart example looks like:

```
IF expression THEN instruction  
ELSE instruction
```

You can also arrange the clauses in one of the following ways to enhance readability:

```
IF expression THEN  
    instruction  
ELSE  
    instruction
```

or

```
IF expression  
    THEN  
        instruction  
    ELSE  
        instruction
```

When you put the entire instruction on one line, you must separate the THEN clause from the ELSE clause with a semicolon.

```
IF expression THEN instruction; ELSE instruction
```

Generally, at least one instruction should follow the THEN and ELSE clauses. When either clause has no instructions, it is good programming practice to include NOP (no operation) next to the clause.

```
IF expression THEN
    instruction
ELSE NOP
```

If you have more than one instruction for a condition, begin the set of instructions with a DO and end them with an END.

```
IF weather = rainy THEN
    SAY 'Find a good book.'
ELSE
    DO
        SAY 'Would you like to play tennis or golf?'
        PULL answer
    END
```

Without the enclosing DO and END, the language processor assumes only one instruction for the ELSE clause.

Nested IF/THEN/ELSE Instructions

Sometimes it is necessary to have one or more IF/THEN/ELSE instructions within other IF/THEN/ELSE instructions. Having one type of instruction within another is called nesting. With nested IF instructions, it is important to match each IF with an ELSE and each DO with an END.

```
IF weather = fine THEN
    DO
        SAY 'What a lovely day!'
        IF tenniscourt = free THEN
            SAY 'Shall we play tennis?'
        ELSE NOP
    END
ELSE
    SAY 'Shall we take our raincoats?'
```

Not matching nested IFs to ELSEs and DOs to ENDS can have some surprising results. If you eliminate the DOs and ENDS and the ELSE NOP, as in the following example, what is the outcome?

Example of Missing Instructions

```

/***** REXX *****/
/* This exec demonstrates what can happen when you do not include */
/* DOs, ENDS, and ELSEs in nested IF/THEN/ELSE instructions.      */
/***** REXX *****/
weather = 'fine'
tenniscourt = 'occupied'

IF weather = 'fine' THEN
    SAY 'What a lovely day!'
    IF tenniscourt = 'free' THEN
        SAY 'Shall we play tennis?'
ELSE
    SAY 'Shall we take our raincoats?'
```

By looking at the exec you might assume the ELSE belongs to the first IF. However, the language processor associates an ELSE with the nearest unpaired IF. The outcome is as follows:

```

What a lovely day!
Shall we take our raincoats?
```

Using Conditional Instructions

Exercise - Using the IF/THEN/ELSE Instruction

Write the REXX instructions for the following flowchart:

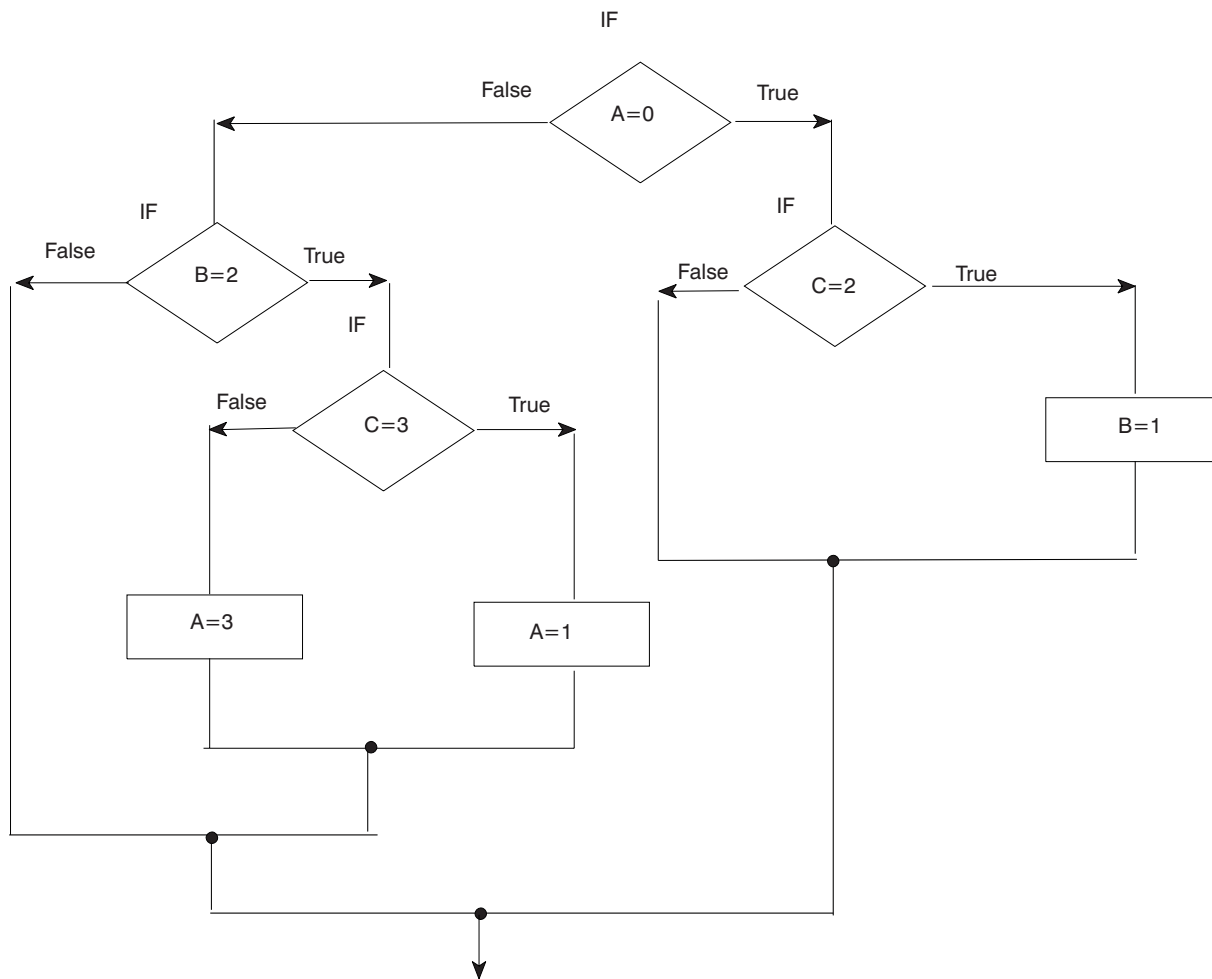

ANSWER

Possible Solution

```
IF A = 0 THEN
  IF C = 2 THEN
    B = 1
  ELSE NOP
ELSE
  IF B = 2 THEN
    IF C = 3 THEN
      A = 1
    ELSE
      A = 3
  ELSE NOP
```

SELECT/WHEN/OTHERWISE/END Instruction

To select one of any number of choices, use the SELECT/WHEN/OTHERWISE/END instruction. In a flowchart it appears as follows:

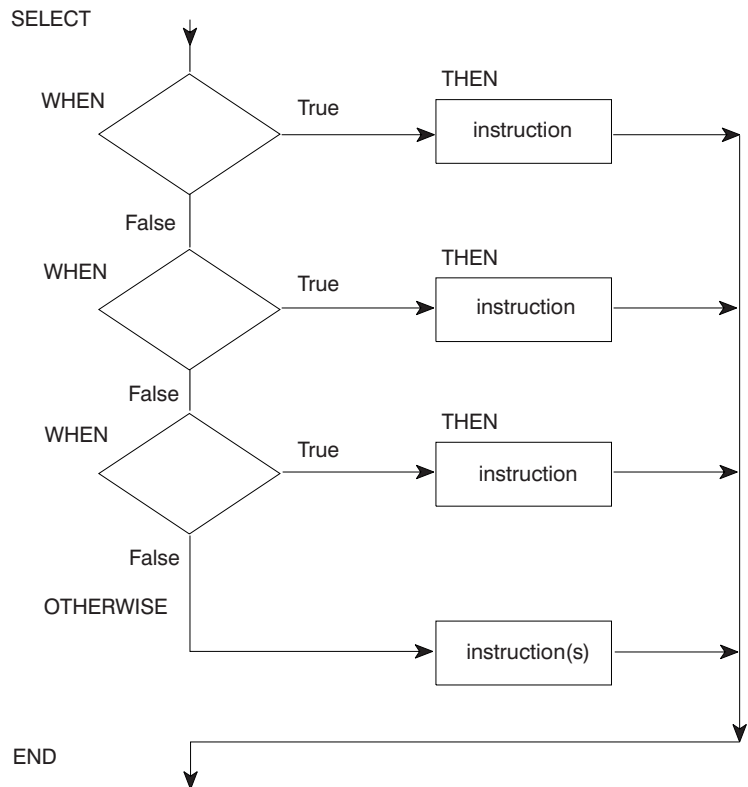

As a REXX instruction, the flowchart example looks like:

```

SELECT
  WHEN expression THEN instruction
  WHEN expression THEN instruction
  WHEN expression THEN instruction
  :
  OTHERWISE
    instruction(s)
END
  
```

The language processor scans the WHEN clauses starting at the beginning until it finds a true expression. After it finds a true expression, it ignores all other possibilities, even though they might also be true. If no WHEN expressions are true, it processes the instructions following the OTHERWISE clause.

As with the IF/THEN/ELSE instruction, when you have more than one instruction for a possible path, begin the set of instructions with a DO and end them with an END. However, if more than one instruction follows the OTHERWISE keyword, DO and END are not necessary.

Using Conditional Instructions

Example Using SELECT/WHEN/OTHERWISE/END

```
/****** REXX *****/
/* This exec receives input with a person's age and sex. In */
/* reply it displays a person's status as follows:          */
/*   BABIES   - under 5                                     */
/*   GIRLS    - female 5 to 12                             */
/*   BOYS     - male 5 to 12                               */
/*   TEENAGERS - 13 through 19                             */
/*   WOMEN    - female 20 and up                           */
/*   MEN      - male 20 and up                             */
/******/
PARSE ARG age sex .

SELECT
  WHEN age < 5 THEN /* person younger than 5 */
    status = 'BABY'
  WHEN age < 13 THEN /* person between 5 and 12 */
    DO
      IF sex = 'M' THEN /* boy between 5 and 12 */
        status = 'BOY'
      ELSE /* girl between 5 and 12 */
        status = 'GIRL'
    END
  WHEN age < 20 THEN /* person between 13 and 19 */
    status = 'TEENAGER'
  OTHERWISE
    IF sex = 'M' THEN /* man 20 or older */
      status = 'MAN'
    ELSE /* woman 20 or older */
      status = 'WOMAN'
END

SAY 'This person should be counted as a' status '.'
```

Each SELECT must end with an END. Indenting each WHEN makes an exec easier to read.

Exercises - Using the SELECT/WHEN/OTHERWISE/END Instruction

"Thirty days hath September, April, June, and November; all the rest have thirty-one, save February alone ..."

Write an exec that provides the number of days in a month. First have the exec ask the user for a month specified as a number from 1 to 12 (with January being 1, February 2, and so forth). Then have the exec reply with the number of days. For month "2", the reply can be "28 or 29".

ANSWER

Possible Solution

```

/***** REXX *****/
/* This exec requests the user to enter a month as a whole number */
/* from 1 to 12 and responds with the number of days in that */
/* month. */
/*****/

SAY 'To find out the number of days in a month,'
SAY 'Enter the month as a number from 1 to 12.'
PULL month

SELECT
  WHEN month = 9 THEN
    days = 30
  WHEN month = 4 THEN
    days = 30
  WHEN month = 6 THEN
    days = 30
  WHEN month = 11 THEN
    days = 30
  WHEN month = 2 THEN
    days = '28 or 29'
  OTHERWISE
    days = 31
END

SAY 'There are' days 'days in Month' month '.'

```

Using Looping Instructions

There are two types of looping instructions, **repetitive loops** and **conditional loops**. Repetitive loops allow you to repeat instructions a certain number of times, and conditional loops use a condition to control repeating. All loops, regardless of the type, begin with the DO keyword and end with the END keyword.

Repetitive Loops

The simplest loop tells the language processor to repeat a group of instructions a specific number of times using a constant following the keyword DO.

```

DO 5
  SAY 'Hello!'
END

```

When you run this example, you see five lines of Hello!.

```

Hello!
Hello!
Hello!
Hello!
Hello!

```

You can also use a variable in place of a constant as in the following example, which gives you the same results.

```

number = 5
DO number
  SAY 'Hello!'
END

```

Using Looping Instructions

A variable that controls the number of times a loop repeats is called a **control variable**. Unless you specify otherwise, the control variable increases by 1 each time the loop repeats.

```
DO number = 1 TO 5
  SAY 'Loop' number
  SAY 'Hello!'
END
  SAY 'Dropped out of the loop when number reached' number
```

This example results in five lines of Hello! preceded by the number of the loop. The number increases at the bottom of the loop and is tested at the top.

```
Loop 1
Hello!
Loop 2
Hello!
Loop 3
Hello!
Loop 4
Hello!
Loop 5
Hello!
Dropped out of the loop when number reached 6
```

You can change the increment of the control variable with the keyword BY as follows:

```
DO number = 1 TO 10 BY 2
  SAY 'Loop' number
  SAY 'Hello!'
END
  SAY 'Dropped out of the loop when number reached' number
```

This example has results similar to the previous example except the loops are numbered in increments of two.

```
Loop 1
Hello!
Loop 3
Hello!
Loop 5
Hello!
Loop 7
Hello!
Loop 9
Hello!
Dropped out of the loop when number reached 11
```

Infinite Loops

What happens when the control variable of a loop cannot attain the last number? For example, in the following exec segment, count does not increase beyond 1.

```
DO count = 1 to 10
  SAY 'Number' count
  count = count - 1
END
```

The result is called an infinite loop because count alternates between 1 and 0 and an endless number of lines saying Number 1 appear on the screen.

IMPORTANT - Stopping An Infinite Loop

When you suspect an exec is in an infinite loop, you can end the exec by pressing the attention interrupt key, sometimes labeled PA1. You will then see message IRX0920I. In response to this message, type HI for halt interpretation and press the Enter key. If that doesn't stop the loop, you can press the attention interrupt key again, type HE for halt execution, and press the Enter key.

HI will not halt an infinitely looping or long running external function, subroutine, or host command written in a language other than REXX and that was called by your exec. The HI condition is not checked by the REXX interpreter until control returns from the function, subroutine, or host command.

Example of EXEC1, an exec that calls an external function

```

/***** REXX *****/
/* Invoke a user-written external function, 'myfunct'. */
/* not written in REXX. For example, it might have been coded */
/* in PL/I or assembler. */
/*****/
x = myfunct(1)
exit

```

If myfunct enters an infinite loop, pressing the attention interrupt key and entering HI will not stop myfunct. However, pressing the attention interrupt key and then entering HE will stop the function and the exec (EXEC1) that called it. HE does not automatically stop any exec that called EXEC1, unless you are running under ISPF. For more information about the HE condition, see *z/OS TSO/E REXX Reference*.

Note: HE does not alter the halt condition, which is raised by HI. If you entered HI before you entered HE (for example, you may have first issued HI and it failed to end your exec), the halt condition will remain set for the exec and all calling execs. HE will stop your exec, and then the halt condition, raised when you entered HI, will be recognized by any exec that called your exec.

DO FOREVER Loops

Sometimes you might want to purposely write an infinite loop; for instance, in an exec that reads records from a data set until it reaches end of file, or in an exec that interacts with a user until the user enters a particular symbol to end the loop. You can use the EXIT instruction to end an infinite loop when a condition is met, as in the following example. More about the EXIT instruction appears in “EXIT Instruction” on page 57.

Using Looping Instructions

Example Using a DO FOREVER Loop

```
/****** REXX ******/
/* This exec prints data sets named by a user until the user enters a
/* a null line. */
/*******/
DO FOREVER
  SAY 'Enter the name of the next data set or a blank to end.'
  PULL dataset_name
  IF dataset_name = '' THEN
    EXIT
  ELSE
    DO
      "PRINTDS DA("dataset_name")"
      SAY dataset_name 'printed.'
    END
  END
END
```

This example sends data sets to the printer and then issues a message that the data set was printed. When the user enters a blank, the loop ends and so does the exec. To end the loop without ending the exec, use the LEAVE instruction, as described in the following topic.

LEAVE Instruction

The LEAVE instruction causes an immediate exit from a repetitive loop. Control goes to the instruction following the END keyword of the loop. An example of using the LEAVE instruction follows:

Example Using the LEAVE Instruction

```
/****** REXX ******/
/* This exec uses the LEAVE instruction to exit from a DO FOREVER */
/* loop that sends data sets to the printer. */
/*******/
DO FOREVER
  SAY 'Enter the name of the next data set.'
  SAY 'When there are no more data sets, enter QUIT.'
  PULL dataset_name
  IF dataset_name = 'QUIT' THEN
    LEAVE
  ELSE
    DO
      "PRINTDS DA("dataset_name")"
      SAY dataset_name 'printed.'
    END
  END
END
SAY 'Good-bye.'
```

ITERATE Instruction

Another instruction, ITERATE, stops execution from within the loop and passes control to the DO instruction at the top of the loop. Depending on the type of DO instruction, a control variable is increased and tested and/or a condition is tested to determine whether to repeat the loop. Like LEAVE, ITERATE is used within the loop.

```
DO count = 1 TO 10
  IF count = 8
    THEN
```

```

        ITERATE
    ELSE
        SAY 'Number' count
END

```

This example results in a list of numbers from 1 to 10 with the exception of number 8.

```

Number 1
Number 2
Number 3
Number 4
Number 5
Number 6
Number 7
Number 9
Number 10

```

Exercises - Using Loops

- What are the results of the following loops?
 - ```

DO digit = 1 TO 3
 SAY digit
END
SAY 'Digit is now' digit

```
  - ```

DO count = 10 BY -2 TO 6
    SAY count
END
SAY 'Count is now' count

```
 - ```

DO index = 10 TO 8
 SAY 'Hup! Hup! Hup!'
END
SAY 'Index is now' index

```
- Sometimes an infinite loop can occur when input to end the loop doesn't match what is expected. For instance, in the previous example using the "LEAVE Instruction" on page 50, what happens when the user enters Quit and the PULL instruction is changed to a PARSE PULL instruction?
 

```

PARSE PULL dataset_name

```

### ANSWERS

- The results of the repetitive loops are as follows:
  - ```

1
2
3
Digit is now 4

```
 - ```

10
8
6
Count is now 4

```
  - ```

(blank)
Index is now 10

```
- The user would be unable to leave the loop because "Quit" is not equal to "QUIT". In this case, omitting the PARSE keyword is preferred because

Using Looping Instructions

regardless of whether the user enters "quit", "QUIT", or "Quit", the language processor translates the input to uppercase before comparing it to "QUIT".

Conditional Loops

There are two types of conditional loops, DO WHILE and DO UNTIL. Both types of loops are controlled by one or more expressions. However, DO WHILE loops test the expression before the loop executes the first time and repeat only when the expression is true. DO UNTIL loops test the expression after the loop executes at least once and repeat only when the expression is false.

DO WHILE Loops

DO WHILE loops in a flowchart appear as follows:

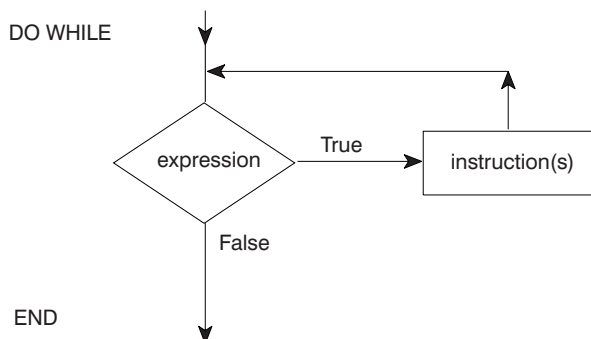

As REXX instructions, the flowchart example looks like:

```
DO WHILE expression          /* expression must be true */
  instruction(s)
END
```

Use a DO WHILE loop when you want to execute the loop while a condition is true. DO WHILE tests the condition at the top of the loop. If the condition is initially false, the loop is never executed.

You can use a DO WHILE loop instead of the DO FOREVER loop in the example using the "LEAVE Instruction" on page 50. However, you need to initialize the loop with a first case so the condition can be tested before you get into the loop. Notice the first case initialization in the beginning three lines of the following example.

Example Using DO WHILE

```
/****** REXX *****/
/* This exec uses a DO WHILE loop to send data sets to the system */
/* printer. */
/******/
SAY 'Enter the name of a data set to print.'
SAY 'If there are no data sets, enter QUIT.'
PULL dataset_name
DO WHILE dataset_name \= 'QUIT'
  "PRINTDS DA("dataset_name")"
  SAY dataset_name 'printed.'
  SAY 'Enter the name of the next data set.'
  SAY 'When there are no more data sets, enter QUIT.'
  PULL dataset_name
END
SAY 'Good-bye.'
```

Exercise - Using a DO WHILE Loop

Write an exec with a DO WHILE loop that asks passengers on a commuter airline if they want a window seat and keeps track of their responses. The flight has 8 passengers and 4 window seats. Discontinue the loop when all the window seats are taken. After the loop ends, display the number of window seats taken and the number of passengers questioned.

ANSWER

Possible Solution

```

/***** REXX *****/
/* This exec uses a DO WHILE loop to keep track of window seats in */
/* an 8-seat commuter airline.                                     */
/*****

window_seats = 0      /* Initialize window seats to 0      */
passenger = 0        /* Initialize passengers to 0        */

DO WHILE (passenger < 8) & (window_seats \= 4)

  /* Continue while you have not questioned all 8 passengers and */
  /* while all the window seats are not taken.                    */
  SAY 'Do you want a window seat? Please answer Y or N.'
  PULL answer
  passenger = passenger + 1
  /* Increase the number of passengers by 1 */
  IF answer = 'Y' THEN
    window_seats = window_seats + 1
    /* Increase the number of window seats by 1 */
  ELSE NOP
END

SAY window_seats 'window seats were assigned.'
SAY passenger 'passengers were questioned.'

```

DO UNTIL Loops

DO UNTIL loops in a flowchart appear as follows:

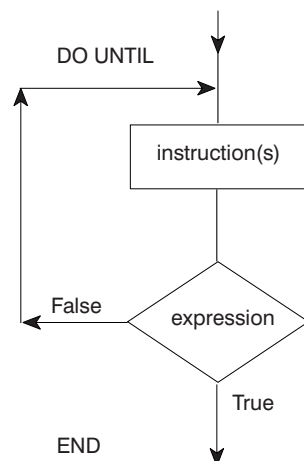

As REXX instructions, the flowchart example looks like:

Using Looping Instructions

```
DO UNTIL expression          /* expression must be false */
  instruction(s)
END
```

Use DO UNTIL loops when a condition is not true and you want to execute the loop until the condition is true. The DO UNTIL loop tests the condition at the end of the loop and repeats only when the condition is false. Otherwise the loop executes once and ends. For example:

Example Using DO UNTIL

```
/****** REXX *****/
/* This exec uses a DO UNTIL loop to ask for a password. If the */
/* password is incorrect three times, the loop ends.          */
/******/
password = 'abracadabra'
time = 0
DO UNTIL (answer = password) | (time = 3)
  SAY 'What is the password?'
  PULL answer
  time = time + 1
END
```

Exercise - Using a DO UNTIL Loop

Change the exec in the previous exercise, “Exercise - Using a DO WHILE Loop” on page 53, from a DO WHILE to a DO UNTIL loop and achieve the same results. Remember that DO WHILE loops check for true expressions and DO UNTIL loops check for false expressions, which means their logical operators are often reversed.

ANSWER

Possible Solution

```
/****** REXX *****/
/* This exec uses a DO UNTIL loop to keep track of window seats in */
/* an 8-seat commuter airline.                                     */
/******/

window_seats = 0          /* Initialize window seats to 0      */
passenger = 0            /* Initialize passengers to 0        */

DO UNTIL (passenger >= 8) | (window_seats = 4)

  /******/
  /* Continue until you have questioned all 8 passengers or until */
  /* all the window seats are taken.                               */
  /******/

  SAY 'Do you want a window seat? Please answer Y or N.'
  PULL answer
  passenger = passenger + 1
  /* Increase the number of passengers by 1 */
  IF answer = 'Y' THEN
    window_seats = window_seats + 1
    /* Increase the number of window seats by 1 */
  ELSE NOP
END
SAY window_seats 'window seats were assigned.'
SAY passenger 'passengers were questioned.'
```

Combining Types of Loops

You can combine repetitive and conditional loops to create a compound loop. The following loop is set to repeat 10 times while a certain condition is met, at which point it stops.

```
quantity = 20
DO number = 1 TO 10 WHILE quantity < 50
  quantity = quantity + number
  SAY 'Quantity = 'quantity ' (Loop 'number')'
END
```

The result of this example is as follows:

```
Quantity = 21 (Loop 1)
Quantity = 23 (Loop 2)
Quantity = 26 (Loop 3)
Quantity = 30 (Loop 4)
Quantity = 35 (Loop 5)
Quantity = 41 (Loop 6)
Quantity = 48 (Loop 7)
Quantity = 56 (Loop 8)
```

You can substitute a DO UNTIL loop, change the comparison operator from < to >, and get the same results.

```
quantity = 20
DO number = 1 TO 10 UNTIL quantity > 50
  quantity = quantity + number
  SAY 'Quantity = 'quantity ' (Loop 'number')'
END
```

Nested DO Loops

Like nested IF/THEN/ELSE instructions, DO loops can also be within other DO loops. A simple example follows:

```
DO outer = 1 TO 2
  DO inner = 1 TO 2
    SAY 'HIP'
  END
  SAY 'HURRAH'
END
```

The output from this example is:

```
HIP
HIP
HURRAH
HIP
HIP
HURRAH
```

If you need to leave a loop when a certain condition arises, use the LEAVE instruction followed by the control variable of the loop. If the LEAVE instruction is for the inner loop, you leave the inner loop and go to the outer loop. If the LEAVE instruction is for the outer loop, you leave both loops.

To leave the inner loop in the preceding example, add an IF/THEN/ELSE instruction that includes a LEAVE instruction after the IF instruction.

```
DO outer = 1 TO 2
  DO inner = 1 TO 2
    IF inner > 1 THEN
      LEAVE inner
    
```

Using Looping Instructions

```
        ELSE
          SAY 'HIP'
        END
      SAY 'HURRAH'
    END
```

The result is as follows:

```
HIP
HURRAH
HIP
HURRAH
```

Exercises - Combining Loops

1. What happens when the following exec runs?

```
DO outer = 1 TO 3
  SAY          /* Write a blank line          */
  DO inner = 1 TO 3
    SAY 'Outer' outer 'Inner' inner
  END
END
```

2. Now what happens when the LEAVE instruction is added?

```
DO outer = 1 TO 3
  SAY          /* Write a blank line          */
  DO inner = 1 TO 3
    IF inner = 2 THEN
      LEAVE inner
    ELSE
      SAY 'Outer' outer 'Inner' inner
    END
  END
END
```

ANSWERS

1. When this example runs, you see on your screen the following:

```
Outer 1 Inner 1
Outer 1 Inner 2
Outer 1 Inner 3

Outer 2 Inner 1
Outer 2 Inner 2
Outer 2 Inner 3

Outer 3 Inner 1
Outer 3 Inner 2
Outer 3 Inner 3
```

2. The result is one line of output for each of the inner loops.

```
Outer 1 Inner 1

Outer 2 Inner 1

Outer 3 Inner 1
```

Using Interrupt Instructions

Instructions that interrupt the flow of an exec can cause the exec to:

- Terminate (EXIT)
- Skip to another part of the exec marked by a label (SIGNAL)

- Go temporarily to a subroutine either within the exec or outside the exec (CALL/RETURN).

EXIT Instruction

The EXIT instruction causes an exec to unconditionally end and return to where the exec was invoked. If the exec was initiated from the PROC section of an ISPF selection panel, EXIT returns to the ISPF panel. If the exec was called by a program, such as another exec, EXIT returns to the program. More about calling external routines appears later in this chapter and in “Chapter 6. Writing Subroutines and Functions” on page 69.

In addition to ending an exec, EXIT can also return a value to the invoker of the exec. If the exec was invoked as a subroutine from another REXX exec, the value is received in the REXX special variable RESULT. If the exec was invoked as a function, the value is received in the original expression at the point where the function was invoked. Otherwise, the value is received in the REXX special variable RC. The value can represent a return code and can be in the form of a constant or an expression that is computed.

Example Using the EXIT Instruction

```
/****** REXX *****/
/* This exec uses the EXIT instruction to end the exec and return */
/* a value that indicates whether or not a job applicant gets the */
/* job. A value of 0 means the applicant does not qualify for */
/* the job, but a value of 1 means the applicant gets the job. */
/* The value is placed in the REXX special variable RESULT. */
/******/
SAY 'How many months of experience do you have? Please enter'
SAY 'the months as a number.'
PULL month

SAY 'Can you supply 3 references? Please answer Y or N.'
PULL reference

SAY 'Are you available to start work tomorrow? Please answer Y or N.'
PULL tomorrow

IF (month > 24) & (reference = 'Y') & (tomorrow = 'Y') THEN
    job = 1 /* person gets the job */
ELSE
    job = 0 /* person does not get the job */

EXIT job
```

CALL/RETURN Instructions

The CALL instruction interrupts the flow of an exec by passing control to an internal or external subroutine. An internal subroutine is part of the calling exec. An external subroutine is another exec. The RETURN instruction returns control from a subroutine back to the calling exec and optionally returns a value.

When calling an internal subroutine, CALL passes control to a label specified after the CALL keyword. When the subroutine ends with the RETURN instruction, the instructions following CALL are executed.

Using Interrupt Instructions

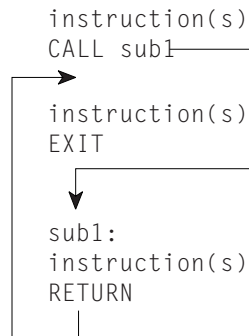

When calling an external subroutine, CALL passes control to the exec name that is specified after the CALL keyword. When the external subroutine completes, you can use the RETURN instruction to return to where you left off in the calling exec.

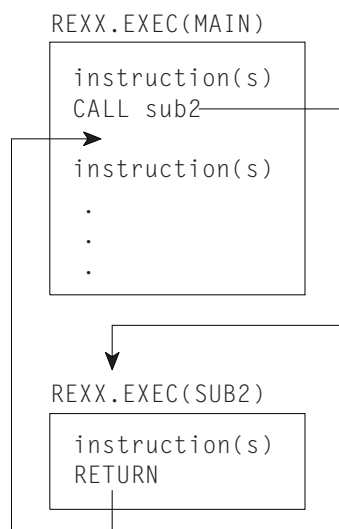

For more information about calling subroutines, see “Chapter 6. Writing Subroutines and Functions” on page 69.

SIGNAL Instruction

The SIGNAL instruction, like CALL, interrupts the normal flow of an exec and causes control to pass to a specified label. The label to which control passes can appear before or after the SIGNAL instruction. Unlike CALL, SIGNAL does not return to a specific instruction to resume execution. When you use SIGNAL from within a loop, the loop automatically ends; and when you use SIGNAL from an internal routine, the internal routine will not return to its caller.

In the following example, if the expression is true, then the language processor goes to the label Emergency: and skips all instructions in between.

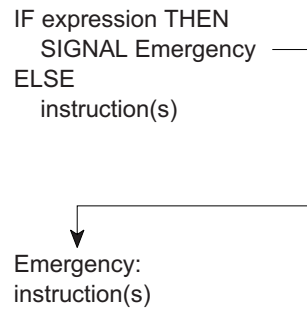

SIGNAL is useful for testing execs or to provide an emergency course of action. It should not be used as a convenient way to move from one place in an exec to another. SIGNAL does not provide a way to return as does the CALL instruction described in “CALL/RETURN Instructions” on page 57.

For more information about the SIGNAL instruction, see page 113, and *z/OS TSO/E REXX Reference*.

Chapter 5. Using Functions

What is a Function?	61
Example of a Function	62
Built-In Functions	63
Arithmetic Functions	63
Comparison Functions	63
Conversion Functions	64
Formatting Functions.	64
String Manipulating Functions	64
Miscellaneous Functions	65
Testing Input with Built-In Functions	66
Exercise - Writing an Exec with Built-In Functions	66

This chapter defines what a function is and describes how to use the built-in functions.

What is a Function?

A function is a sequence of instructions that can receive data, process that data, and return a value. In REXX, there are several kinds of functions:

- Built-in functions — These functions are built into the language processor. More about built-in functions appears later in this chapter.
- User-written functions — These functions are written by an individual user or supplied by an installation and can be internal or external. An *internal function* is part of the current exec that starts at a label. An *external function* is a self-contained program or exec outside of the calling exec. More information about user-written functions appears in “Writing a Function” on page 77.
- Function packages — These are groups of functions and subroutines written by an individual user or supplied by an installation. They are link-edited into load modules and categorized as user, local, and system. TSO/E external functions are provided in a system function package. More information about TSO/E external functions appears in “TSO/E External Functions” on page 119.

Regardless of the kind of function, all functions return a value to the exec that issued the function call. To call a function, type the function name directly followed by one or more arguments within parentheses. **There can be no space between the function name and the left parenthesis.**

```
function(arguments)
```

A function call can contain up to 20 arguments separated by commas. Each argument can be one or more of the following.

- Blank
 function()
- Constant
 function(55)
- Symbol
 function(symbol_name)
- Literal string
 function('With a literal string')
- Option recognized by the function

What is a Function?

function(option)

- Another function

function(function(arguments))

- Combination of argument types

function('With a literal string', 55, option)

When the function returns a value, and all functions must return values, the value replaces the function call. In the following example, the value returned is added to 7 and the sum is displayed.

SAY 7 + function(arguments)

A function call generally appears in an expression. Therefore a function call, like an expression, does not usually appear in an instruction by itself.

Example of a Function

Calculations represented by functions often require many instructions. For instance, the simple calculation for finding the highest number in a group of three numbers, might be written as follows:

Finding a Maximum Number

```
/****** REXX *****/
/* This exec receives three numbers from a user and analyzes which */
/* number is the greatest. */
/*******/

PARSE ARG number1, number2, number3 .

IF number1 > number2 THEN
  IF number1 > number3 THEN
    greatest = number1
  ELSE
    greatest = number3
ELSE
  IF number2 > number3 THEN
    greatest = number2
  ELSE
    greatest = number3

RETURN greatest
```

Rather than writing multiple instructions every time you want to find the maximum of a group of three numbers, you can use a built-in function that does the calculation for you and returns the maximum number. The function is called MAX and is used as follows:

```
MAX(number1,number2,number3,...)
```

To find the maximum of 45, -2, number, 199, and put the maximum into the symbol biggest, write the following instruction:

```
biggest = MAX(45,-2,number,199)
```

Built-In Functions

Over 50 functions are built into the language processor. The built-in functions fall into the following categories:

- Arithmetic functions
These functions evaluate numbers from the argument and return a particular value.
- Comparison functions
These functions compare numbers and/or strings and return a value.
- Conversion functions
These functions convert one type of data representation to another type of data representation.
- Formatting functions
These functions manipulate the characters and spacing in strings supplied in the argument.
- String manipulating functions
These functions analyze a string supplied in the argument (or a variable representing a string) and return a particular value.
- Miscellaneous functions
These functions do not clearly fit into any of the other categories.

The following tables briefly describe the functions in each category. For a complete description of these functions, see *z/OS TSO/E REXX Reference*.

Arithmetic Functions

Function	Description
ABS	Returns the absolute value of the input number.
DIGITS	Returns the current setting of NUMERIC DIGITS.
FORM	Returns the current setting of NUMERIC FORM.
FUZZ	Returns the current setting of NUMERIC FUZZ.
MAX	Returns the largest number from the list specified, formatted according to the current NUMERIC settings.
MIN	Returns the smallest number from the list specified, formatted according to the current NUMERIC settings.
RANDOM	Returns a quasi-random, non-negative whole number in the range specified.
SIGN	Returns a number that indicates the sign of the input number.
TRUNC	Returns the integer part of the input number, and optionally a specified number of decimal places.

Comparison Functions

Function	Description
COMPARE	Returns 0 if the two input strings are identical. Otherwise, returns the position of the first character that does not match.
DATATYPE	Returns a string indicating the input string is a particular data type, such as a number or character.

Built-In Functions

Function	Description
SYMBOL	Returns this state of the symbol (variable, literal, or bad).

Conversion Functions

Function	Description
B2X	Returns a string, in character format, that represents the input binary string converted to hexadecimal. (Binary to hexadecimal)
C2D	Returns the decimal value of the binary representation of the input string. (Character to Decimal)
C2X	Returns a string, in character format, that represents the input string converted to hexadecimal. (Character to Hexadecimal)
D2C	Returns a string, in character format, that represents the input decimal number converted to binary. (Decimal to Character)
D2X	Returns a string, in character format, that represents the input decimal number converted to hexadecimal. (Decimal to Hexadecimal)
X2B	Returns a string, in character format, that represents the input hexadecimal string converted to binary. (Hexadecimal to binary)
X2C	Returns a string, in character format, that represents the input hexadecimal string converted to character. (Hexadecimal to Character)
X2D	Returns the decimal representation of the input hexadecimal string. (Hexadecimal to Decimal)

Formatting Functions

Function	Description
CENTER/ CENTRE	Returns a string of a specified length with the input string centered in it, with pad characters added as necessary to make up the length.
COPIES	Returns the specified number of concatenated copies of the input string.
FORMAT	Returns the input number, rounded and formatted.
JUSTIFY *	Returns a specified string formatted by adding pad characters between words to justify to both margins.
LEFT	Returns a string of the specified length, truncated or padded on the right as needed.
RIGHT	Returns a string of the specified length, truncated or padded on the left as needed.
SPACE	Returns the words in the input string with a specified number of pad characters between each word.
* Indicates a non-SAA built-in function provided only by TSO/E.	

String Manipulating Functions

Function	Description
ABBREV	Returns a string indicating if one string is equal to the specified number of leading characters of another string.
DELSTR	Returns a string after deleting a specified number of characters, starting at a specified point in the input string.

Built-In Functions

Function	Description
DELWORD	Returns a string after deleting a specified number of words, starting at a specified word in the input string.
FIND *	Returns the word number of the first word of a specified phrase found within the input string.
INDEX *	Returns the character position of the first character of a specified string found in the input string.
INSERT	Returns a character string after inserting one input string into another string after a specified character position.
LASTPOS	Returns the starting character position of the last occurrence of one string in another.
LENGTH	Returns the length of the input string.
OVERLAY	Returns a string that is the target string overlaid by a second input string.
POS	Returns the character position of one string in another.
REVERSE	Returns a character string, the characters of which are in reverse order (swapped end for end).
STRIP	Returns a character string after removing leading or trailing characters or both from the input string.
SUBSTR	Returns a portion of the input string beginning at a specified character position.
SUBWORD	Returns a portion of the input string starting at a specified word number.
TRANSLATE	Returns a character string with each character of the input string translated to another character or unchanged.
VERIFY	Returns a number indicating whether an input string is composed only of characters from another input string or returns the character position of the first unmatched character.
WORD	Returns a word from an input string as indicated by a specified number.
WORDINDEX	Returns the character position in an input string of the first character in the specified word.
WORDLENGTH	Returns the length of a specified word in the input string.
WORDPOS	Returns the word number of the first word of a specified phrase in the input string.
WORDS	Returns the number of words in the input string.
* Indicates a non-SAA built-in function provided only by TSO/E.	

Miscellaneous Functions

Function	Description
ADDRESS	Returns the name of the environment to which commands are currently being sent.
ARG	Returns an argument string or information about the argument strings to a program or internal routine.
BITAND	Returns a string composed of the two input strings logically ANDed together, bit by bit.
BITOR	Returns a string composed of the two input strings logically ORed together, bit by bit.

Built-In Functions

Function	Description
BITXOR	Returns a string composed of the two input strings eXclusive ORed together, bit by bit.
CONDITION	Returns the condition information, such as name and status, associated with the current trapped condition.
DATE	Returns the date in the default format (dd mon yyyy) or in one of various optional formats.
ERRORTEXT	Returns the error message associated with the specified error number.
EXTERNALS *	Returns the number of elements in the terminal input buffer. In TSO/E, this function always returns a 0.
LINESIZE *	Returns the current terminal line width minus 1.
QUEUED	Returns the number of lines remaining in the external data queue at the time when the function is invoked.
SOURCELINE	Returns either the line number of the last line in the source file or the source line specified by a number.
TIME	Returns the local time in the default 24-hour clock format (hh:mm:ss) or in one of various optional formats.
TRACE	Returns the trace actions currently in effect.
USERID *	Returns the TSO/E user ID, if the REXX exec is running in the TSO/E address space.
VALUE	Returns the value of a specified symbol and optionally assigns it a new value.
XRANGE	Returns a string of all 1-byte codes (in ascending order) between and including specified starting and ending values.
* Indicates a non-SAA built-in function provided only by TSO/E.	

Testing Input with Built-In Functions

Some of the built-in functions provide a convenient way to test input. When an interactive exec requests input, the user might respond with input that is not valid. For instance, in the example “Using Comparison Expressions” on page 31, the exec requests a dollar amount with the following instructions.

```
SAY 'What did you spend for lunch yesterday?'
SAY 'Please do not include the dollar sign.'
PARSE PULL last
```

If the user responds with a number only, the exec will process that information correctly. If the user responds with a number preceded by a dollar sign or with a word, such as nothing, the exec will return an error. To avoid getting an error, you can check the input with the DATATYPE function as follows:

```
DO WHILE DATATYPE(last) \= 'NUM'
  SAY 'Please enter the lunch amount again.'
  SAY 'The amount you entered was not a number without a dollar sign.'
  PARSE PULL last
END
```

Other useful built-in functions to test input are WORDS, VERIFY, LENGTH, and SIGN.

Exercise - Writing an Exec with Built-In Functions

Write an exec that checks a data set member name for a length of 8 characters. If a member name is longer than 8 characters, the exec truncates it to 8 and sends

the user a message indicating the shortened name. Use the LENGTH and the SUBSTR built-in functions as described in *z/OS TSO/E REXX Reference*.

ANSWER

Possible Solution

```
/****** REXX ******/
/* This exec tests the length of a name for a data set member. If */
/* the name is longer than 8 characters, the exec truncates the */
/* extra characters and sends the user a message indicating the */
/* shortened member name. */
/*******/
SAY 'Please enter a member name.'
PULL membername

IF LENGTH(membername) > 8 THEN /* Name is longer than 8 characters*/
  DO
    membername = SUBSTR(membername,1,8) /* Shorten the name to */
                                         /* the first 8 characters*/
    SAY 'The member name you entered was too long.'
    SAY membername 'will be used.'
  END
ELSE NOP
```

Built-In Functions

Chapter 6. Writing Subroutines and Functions

What are Subroutines and Functions?	69
When to Write Subroutines vs. Functions	70
Writing a Subroutine	70
Passing Information to a Subroutine	72
Passing Information by Using Variables	72
Passing Information by Using Arguments	74
Receiving Information from a Subroutine	75
Example - Writing an Internal and an External Subroutine	76
Writing a Function.	77
Passing Information to a Function	79
Passing Information by Using Variables	79
Passing Information by Using Arguments	81
Receiving Information from a Function	83
Exercise - Writing a Function.	83
Summary of Subroutines and Functions.	83

This chapter shows how to write subroutines and functions and compares their differences and similarities.

What are Subroutines and Functions?

Subroutines and functions are routines made up of a sequence of instructions that can receive data, process that data, and return a value. The routines can be:

- Internal** The routine is within the current exec, marked by a label and used only by that exec.
- External** A program or exec in a member of a partitioned data set that can be called by one or more execs. In order for an exec to call the routine, the exec and the routine must be allocated to a system file, for example SYSEXEC or SYSPROC, or be in the same PDS. For more information about allocating to a system file, see “Appendix A. Allocating Data Sets” on page 185.

In many aspects, subroutines and functions are the same; yet they are different in a few major aspects, such as the way they are called and the way they return values.

- Calling a subroutine

To call a subroutine, use the CALL instruction followed by the subroutine name (label or exec member name) and optionally followed by up to 20 arguments separated by commas. The subroutine call is an entire instruction.

```
CALL subroutine_name argument1, argument2,...
```

Issuing a CALL to internal label names for REXX subroutines and functions that are greater than eight characters, may have unintended results. Label names will be truncated to eight characters.

- Calling a function

To call a function, use the function name (label or exec member name) immediately followed by parentheses that can contain arguments. There can be no space between the function name and the parentheses. The function call is part of an instruction, for example, an assignment instruction.

```
x = function(argument1, argument2,...)
```

- Returning a value from a subroutine

What are Subroutines and Functions?

A subroutine does not have to return a value, but when it does, it sends back the value with the RETURN instruction.

```
RETURN value
```

The calling exec receives the value in the REXX special variable named RESULT.

```
SAY 'The answer is' RESULT
```

- Returning a value from a function

A function *must* return a value. When the function is a REXX exec, the value is returned with either the RETURN or EXIT instruction.

```
RETURN value
```

The calling exec receives the value at the function call. The value replaces the function call, so that in the following example, x = value.

```
x = function(argument1, argument2,...)
```

When to Write Subroutines vs. Functions

The actual instructions that make up a subroutine or a function can be identical. It is the way you want to use them in an exec that turns them into either a subroutine or a function. For example, the built-in function SUBSTR can be called as either a function or a subroutine. As a function, you invoke it as follows to shorten a word to its first eight characters:

```
x = SUBSTR('verylongword',1,8)          /* x is set to 'verylong' */
```

As a subroutine, you would get the same results with the following instructions:

```
CALL SUBSTR 'verylongword', 1, 8       /* x is set to 'verylong' */  
x = RESULT
```

When deciding whether to write a subroutine or a function, ask yourself the following questions:

- Is a returned value optional? If so, write a subroutine.
- Do I need a value returned as an expression within an instruction? If so, write a function.

The rest of this chapter describes how to write subroutines, how to write functions, and finally summarizes the differences and similarities between the two.

Writing a Subroutine

A subroutine is a series of instructions that an exec invokes to perform a specific task. The instruction that invokes the subroutine is the CALL instruction. The CALL instruction may be used several times in an exec to invoke the same subroutine.

When the subroutine ends, it can return control to the instruction that directly follows the subroutine call. The instruction that returns control is the RETURN instruction.

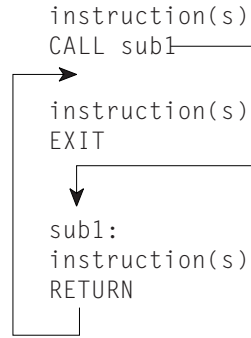

Subroutines may be **internal** and designated by a label, or **external** and designated by the data set member name that contains the subroutine. The preceding example illustrates an internal subroutine named "sub1".

IMPORTANT NOTE

Because internal subroutines generally appear after the main part of the exec, when you have an internal subroutine, it is important to end the main part of the exec with the EXIT instruction.

The following illustrates an external subroutine named "sub2". To determine whether to make a subroutine internal or external, you might consider

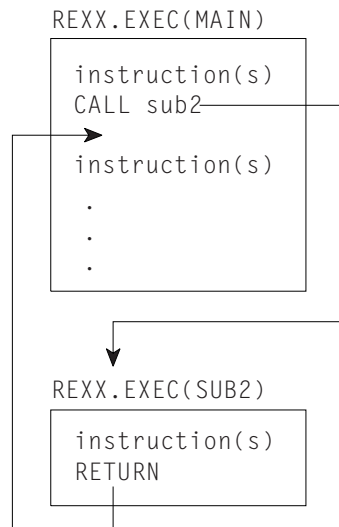

factors, such as:

- Size of the subroutine. Very large subroutines often are external, whereas small subroutines fit easily within the calling exec.
- How you want to pass information. It is quicker to pass information through variables in an internal subroutine. This method is described in "Passing Information by Using Variables" on page 72.
- Whether the subroutine might be of value to more than one exec or user. If so, an external subroutine is preferable.

Writing a Subroutine;

Passing Information to a Subroutine

An internal subroutine can share variables with its caller. Therefore you can use commonly shared variables to pass information between caller and internal subroutine. You can also use arguments to pass information to and from an internal subroutine. External subroutines, however, cannot share the same variables, and information must pass between them through arguments or some other external way, such as the data stack.

Passing Information by Using Variables

When an exec and its internal subroutine share the same variables, the value of a variable is what was last assigned, regardless of whether the assignment was in the main part of the exec or in the subroutine. In the following example, the value of answer is assigned in the subroutine and displayed in the main part of the exec. The variables number1, number2, and answer are shared.

Example of Passing Information in a Variable

```
/****** REXX ******/
/* This exec receives a calculated value from an internal */
/* subroutine and displays that value. */
/*******/

number1 = 5
number2 = 10
CALL subroutine
SAY answer /* Displays 15 */
EXIT

subroutine:
answer = number1 + number2
RETURN
```

Using the same variables in an exec and its internal subroutine can sometimes create problems. In the following example, the main part of the exec and the subroutine use the same control variable, "i", for their DO loops. As a result, the DO loop repeats only once in the main exec because the subroutine returns to the main exec with i = 6.

Example of a Problem Caused by Passing Information in a Variable

```

/***** REXX *****/
/* NOTE: This exec contains an error. */
/* It uses a DO loop to call an internal subroutine and the */
/* subroutine also uses a DO loop with same control variable as */
/* the main exec. The DO loop in the main exec repeats only once. */
/*****

number1 = 5
number2 = 10
DO i = 1 TO 5
  CALL subroutine
  SAY answer /* Displays 105 */
END
EXIT

subroutine:
DO i = 1 TO 5
  answer = number1 + number2
  number1 = number2
  number2 = answer
END
RETURN

```

To avoid this kind of problem in an internal subroutine, you can use:

- The PROCEDURE instruction as described in the next topic.
- Different variable names in a subroutine and pass arguments on the CALL instruction as described in “Passing Information by Using Arguments” on page 74.

Protecting Variables with the PROCEDURE Instruction: When you use the PROCEDURE instruction immediately after the subroutine label, all variables used in the subroutine become local to the subroutine and are shielded from the main part of the exec. You can also use the PROCEDURE EXPOSE instruction to protect all but a few specified variables.

The following two examples show the differing results when a subroutine uses the PROCEDURE instruction and when it doesn't.

Example Using the PROCEDURE Instruction

```

/***** REXX *****/
/* This exec uses a PROCEDURE instruction to protect the variables */
/* within its subroutine. */
/*****

number1 = 10
CALL subroutine
SAY number1 number2 /* displays 10 NUMBER2 */
EXIT

subroutine: PROCEDURE
number1 = 7
number2 = 5
RETURN

```

Writing a Subroutine;

Example Without the PROCEDURE Instruction

```
/* ***** REXX ***** */
/* This exec does not use a PROCEDURE instruction to protect the */
/* variables within its subroutine.                               */
/* ***** */
number1 = 10
CALL subroutine
SAY number1 number2          /* displays 7 5 */
EXIT

subroutine:
number1 = 7
number2 = 5
RETURN
```

Exposing Variables with PROCEDURE EXPOSE: To protect all but specific variables, use the EXPOSE option with the PROCEDURE instruction, followed by the variables that are to remain exposed to the subroutine.

Example Using PROCEDURE EXPOSE

```
/* ***** REXX ***** */
/* This exec uses a PROCEDURE instruction with the EXPOSE option to */
/* expose one variable, number1, in its subroutine. The other      */
/* variable, number2, is set to null and displays its name in     */
/* uppercase.                                                      */
/* ***** */
number1 = 10
CALL subroutine
SAY number1 number2          /* displays 7 NUMBER2 */
EXIT

subroutine: PROCEDURE EXPOSE number1
number1 = 7
number2 = 5
RETURN
```

For more information about the PROCEDURE instruction, see *z/OS TSO/E REXX Reference*.

Passing Information by Using Arguments

A way to pass information to either internal or external subroutines is through arguments. You can pass up to 20 arguments separated by commas on the CALL instruction as follows:

```
CALL subroutine_name argument1, argument2, argument3,.....
```

Using the ARG Instruction: The subroutine can receive the arguments with the ARG instruction. Arguments are also separated by commas in the ARG instruction.

```
ARG arg1, arg2, arg3, .....
```

The names of the arguments on the CALL and the ARG instructions do not have to be the same because information is not passed by argument name but by position. The first argument sent becomes the first argument received and so forth. You can also set up a template in the CALL instruction, which is then used in the corresponding ARG instruction. For information about parsing with templates, see "Parsing Data" on page 87.

Writing a Subroutine;

The following exec sends information to an internal subroutine that computes the perimeter of a rectangle. The subroutine returns a value in the variable `perim` that is specified after the `RETURN` instruction. The main exec receives the value in the special variable `"RESULT"`.

Example of Passing Arguments on the CALL Instruction

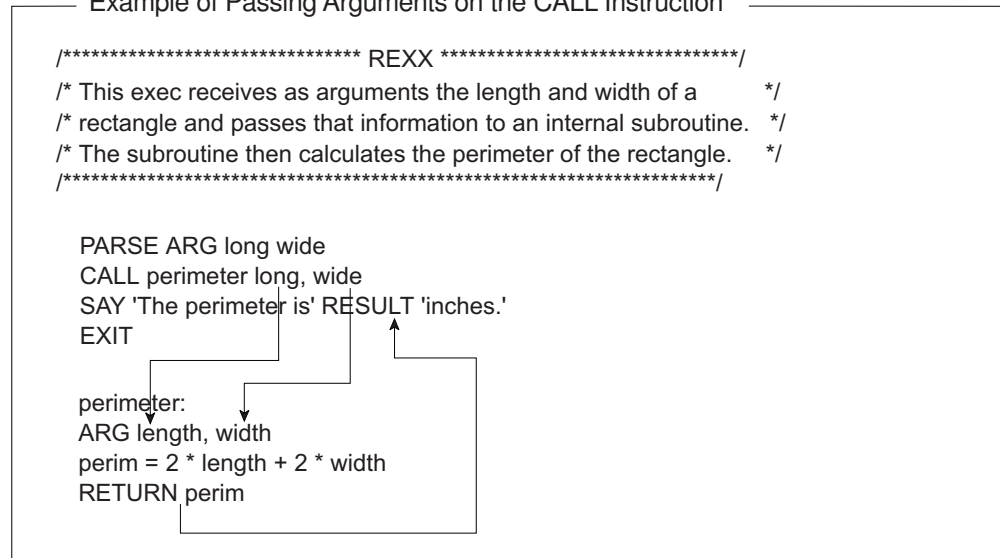

Notice the positional relationships between `long` and `length`, and `wide` and `width`. Also notice how information is received from variable `perim` in the special variable `RESULT`.

Using the ARG Built-in Function: Another way for a subroutine to receive arguments is with the `ARG` built-in function. This function returns the value of a particular argument specified by a number that represents the argument position.

For instance, in the previous example, instead of the `ARG` instruction, `ARG length, width`

you can use the `ARG` function as follows:

```
length = ARG(1)      /* puts the first argument into length */
width = ARG(2)       /* puts the second argument into width */
```

More information about the `ARG` function appears in *z/OS TSO/E REXX Reference*.

Receiving Information from a Subroutine

Although a subroutine can receive up to 20 arguments, it can specify only one expression on the `RETURN` instruction. That expression can be:

- A number
`RETURN 55`
- One or more variables whose values are substituted or when no values were assigned, return their names
`RETURN value1 value2 value3`
- A literal string
`RETURN 'Work complete.'`
- An arithmetic, comparison, or logical expression whose value is substituted.
`RETURN 5 * number`

Writing a Subroutine;

Example - Writing an Internal and an External Subroutine

Write an exec that plays a simulated coin toss game of heads or tails between the computer and a user and displays the accumulated scores. Start off with the message, "This is a game of chance. Type 'heads', 'tails', or 'quit' and press the Enter key."

This means that there are four possible inputs:

- HEADS
- TAILS
- QUIT
- None of these three (not valid response).

Write an internal subroutine without arguments to check for valid input. Send valid input to an external subroutine that compares the valid input with a random outcome. Use the RANDOM built-in function as, RANDOM(0,1), and equate HEADS = 0, TAILS = 1. Return the result to the main program where results are tallied and displayed.

Good luck!

ANSWER

Possible Solution (Main Exec)

```
/****** REXX *****/
/* This exec plays a simulated coin toss game between the computer */
/* and a user. The user enters heads, tails, or quit. The user */
/* is first checked for validity in an internal subroutine. */
/* An external subroutine uses the RANDOM build-in function to */
/* obtain a simulation of a throw of dice and compares the user */
/* input to the random outcome. The main exec receives */
/* notification of who won the round. Scores are maintained */
/* and displayed after each round. */
/******/
SAY 'This is a game of chance. Type "heads", "tails", or "quit"
SAY ' and press ENTER.'
PULL response
computer = 0; user = 0 /* initialize scores to zero */
CALL check /* call internal subroutine, check */
DO FOREVER
CALL throw response /* call external subroutine, throw */

IF RESULT = 'machine' THEN /* the computer won */
computer = computer + 1 /* increase the computer score */
ELSE /* the user won */
user = user + 1 /* increase the user score */

SAY 'Computer score = ' computer ' Your score = ' user
SAY 'Heads, tails, or quit?'
PULL response
CALL check /* call internal subroutine, check */
END
EXIT
```

Possible Solution (Internal Subroutine named CHECK)

```

check:
/*****
/* This internal subroutine checks for valid input of "HEADS",
/* "TAILS", or "QUIT". If the user entered anything else, the
/* subroutine tells the user that it is an invalid response and
/* asks the user to try again. The subroutine keeps repeating
/* until the user enters valid input. Information is returned to
/* the main exec through commonly used variables.
*****/
DO UNTIL outcome = 'correct'
  SELECT
    WHEN response = 'HEADS' THEN
      outcome = 'correct'
    WHEN response = 'TAILS' THEN
      outcome = 'correct'
    WHEN response = 'QUIT' THEN
      EXIT
    OTHERWISE
      outcome = 'incorrect'
      SAY "That's not a valid response. Try again!"
      SAY "Heads, tails, or quit?"
      PULL response
  END
END
RETURN

```

Possible Solution (External Subroutine named THROW)

```

/***** REXX *****/
/* This external subroutine receives the valid input from the user,
/* analyzes it, gets a random "throw" from the computer and
/* compares the two values. If they are the same, the user wins.
/* If they are different, the computer wins. The outcome is then
/* returned to the calling exec.
*****/
ARG input
IF input = 'HEADS' THEN
  userthrow = 0          /* heads = 0 */
ELSE
  userthrow = 1          /* tails = 1 */

compthrow = RANDOM(0,1) /* choose a random number between
                        /* 0 and 1 */

IF compthrow = userthrow THEN
  outcome = 'human'     /* user chose correctly */
ELSE
  outcome = 'machine'   /* user didn't choose correctly */

RETURN outcome

```

Writing a Function

A function is a series of instructions that an exec invokes to perform a specific task and return a value. As was described in “Chapter 5. Using Functions” on page 61, a function may be built-in or user-written. An exec invokes a user-written function the same way it invokes a built-in function — by the function name immediately

Writing a Function

followed by parentheses with no blanks in between. The parentheses can contain up to 20 arguments or no arguments at all.

```
function(argument1, argument2,...)
```

or

```
function()
```

A function requires a returned value because the function call generally appears in an expression.

```
x = function(arguments1, argument2,...)
```

When the function ends, it may use the RETURN instruction to send back a value to replace the function call.

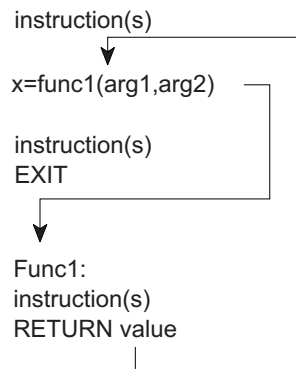

Functions may be **internal** and designated by a label, or **external** and designated by the data set member name that contains the function. The previous example illustrates an internal function named "func1".

IMPORTANT NOTE

Because internal functions generally appear after the main part of the exec, when you have an internal function, it is important to end the main part of the exec with the EXIT instruction.

The following illustrates an external function named "func2".

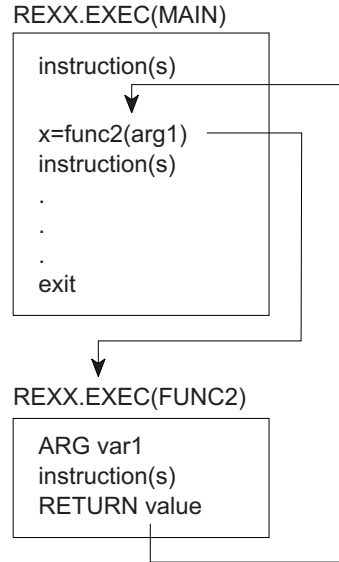

To determine whether to make a function internal or external, you might consider factors, such as:

- Size of the function. Very large functions often are external, whereas small functions fit easily within the calling exec.
- How you want to pass information. It is quicker to pass information through variables in an internal function. This method is described in the next topic under “Passing Information by Using Variables”.
- Whether the function might be of value to more than one exec or user. If so, an external function is preferable.
- Performance. The language processor searches for an internal function before it searches for an external function. For the complete search order of functions, see “Search Order for Functions” on page 134.

Passing Information to a Function

When an exec and its internal function share the same variables, you can use commonly shared variables to pass information between caller and internal function. The function does not need to pass arguments within the parentheses that follow the function call. However, all functions, both internal and external, must return a value.

Passing Information by Using Variables

When an exec and its internal function share the same variables, the value of a variable is what was last assigned, regardless of whether the assignment was in the main part of the exec or in the function. In the following example, the value of answer is assigned in the function and displayed in the main part of the exec. The variables number1, number2, and answer are shared. In addition, the value of answer replaces the function call because answer follows the RETURN instruction.

Writing a Function

Example of Passing Information in a Variable

```
/****** REXX ******/
/* This exec receives a calculated value from an internal */
/* function and displays that value. */
/*******/

number1 = 5
number2 = 10
SAY add() /* Displays 15 */
SAY answer /* Also displays 15 */
EXIT

add:
answer = number1 + number2
RETURN answer
```

Using the same variables in an exec and its internal function can sometimes create problems. In the following example, the main part of the exec and the function use the same control variable, "i", for their DO loops. As a result, the DO loop repeats only once in the main exec because the function returns to the main exec with i = 6.

Example of a Problem Caused by Passing Information in a Variable

```
/****** REXX ******/
/* This exec uses an instruction in a DO loop to call an internal */
/* function. A problem occurs because the function also uses a DO */
/* loop with the same control variable as the main exec. The DO */
/* loop in the main exec repeats only once. */
/*******/

number1 = 5
number2 = 10
DO i = 1 TO 5
SAY add() /* Displays 105 */
END
EXIT

add:
DO i = 1 TO 5
answer = number1 + number2
number1 = number2
number2 = answer
END
RETURN answer
```

To avoid this kind of problem in an internal function, you can use:

- The PROCEDURE instruction as described in the next topic.
- Different variable names in a function.

Protecting Variables with the PROCEDURE Instruction: When you use the PROCEDURE instruction immediately following the function label, all variables used in the function become local to the function and are shielded from the main part of the exec. You can also use the PROCEDURE EXPOSE instruction to protect all but a few specified variables.

Writing a Function

The following two examples show the differing results when a function uses the PROCEDURE instruction and when it doesn't.

Example Using the PROCEDURE Instruction

```
/****** REXX *****/
/* This exec uses a PROCEDURE instruction to protect the variables */
/* within its function. */
/****** REXX *****/
number1 = 10
SAY pass() number2          /* Displays 7 NUMBER2 */
EXIT

pass: PROCEDURE
number1 = 7
number2 = 5
RETURN number1
```

Example Without the PROCEDURE Instruction

```
/****** REXX *****/
/* This exec does not use a PROCEDURE instruction to protect the */
/* variables within its function. */
/****** REXX *****/
number1 = 10
SAY pass() number2          /* displays 7 5 */
EXIT

pass:
number1 = 7
number2 = 5
RETURN number1
```

Exposing Variables with PROCEDURE EXPOSE: To protect all but specific variables, use the EXPOSE option with the PROCEDURE instruction, followed by the variables that are to remain exposed to the function.

Example Using PROCEDURE EXPOSE

```
/****** REXX *****/
/* This exec uses a PROCEDURE instruction with the EXPOSE option to */
/* expose one variable, number1, in its function. */
/****** REXX *****/
number1 = 10
SAY pass() number1          /* displays 5 7 */
EXIT

pass: PROCEDURE EXPOSE number1
number1 = 7
number2 = 5
RETURN number2
```

For more information about the PROCEDURE instruction, see *z/OS TSO/E REXX Reference*.

Passing Information by Using Arguments

A way to pass information to either internal or external functions is through arguments. You can pass up to 20 arguments separated by commas in a function call.

Writing a Function

```
function(argument1,argument2,argument3,.....)
```

Using the ARG Instruction: The function can receive the arguments with the ARG instruction. Arguments are also separated by commas in the ARG instruction.

```
ARG arg1,arg2,arg3 .....
```

The names of the arguments on the function call and the ARG instruction do not have to be the same because information is not passed by argument name but by position. The first argument sent becomes the first argument received and so forth. You can also set up a template in the function call, which is then used in the corresponding ARG instruction. For information about parsing templates, see “Parsing Data” on page 87.

The following exec sends information to an internal function that computes the perimeter of a rectangle. The function returns a value in the variable perim that is specified after the RETURN instruction. The main exec uses the value in perim to replace the function call.

Example of an Internal Function

```
/****** REXX *****/
/* This exec receives as arguments the length and width of a */
/* rectangle and passes that information to an internal function */
/* named perimeter. The function then calculates the perimeter of */
/* the rectangle. */
/****** */
```

```
PARSE ARG long wide
SAY 'The perimeter is' perimeter(long,wide) 'inches.'
EXIT

perimeter:
ARG length, width
perim = 2 * length + 2 * width
RETURN perim
```

Notice the positional relationships between long and length, and wide and width. Also notice that information is received from variable perim to replace the function call.

Using the ARG Built-in Function: Another way for a function to receive arguments is with the ARG built-in function. This built-in function returns the value of a particular argument specified by a number that represents the argument position.

For instance, in the previous example, instead of the ARG instruction,
ARG length, width

you can use the ARG function as follows:

```
length = ARG(1)          /* puts the first argument into length */
width = ARG(2)           /* puts the second argument into width */
```

More information about the ARG function appears in *z/OS TSO/E REXX Reference*.

Receiving Information from a Function

Although a function can receive up to 20 arguments in a function call, it can specify only one expression on the RETURN instruction. That expression can be a:

- Number
RETURN 55
- One or more variables whose values are substituted or when no values were assigned, return their names
RETURN value1 value2 value3
- Literal string
RETURN 'Work complete.'
- Arithmetic, comparison, or logical expression whose value is substituted.
RETURN 5 * number

Exercise - Writing a Function

Write a function named "AVG" that receives a list of numbers separated by blanks, and computes their average as a decimal number. The function is called as follows:

```
AVG(number1 number2 number3 ...)
```

Use the WORDS and WORD built-in functions. For more information about these built-in functions, see *z/OS TSO/E REXX Reference*.

ANSWER

Possible Solution

```

/***** REXX *****/
/* This function receives a list of numbers, adds them, computes */
/* their average and returns the average to the calling exec.    */
/*****

ARG numlist          /* receive the numbers in a single variable */

sum = 0              /* initialize sum to zero                */

DO n = 1 TO WORDS(numlist) /* Repeat for as many times as there */
                          /* are numbers                          */

    number = WORD(numlist,n) /* Word #n goes to number              */
    sum = sum + number      /* Sum increases by number             */
END

average = sum / WORDS(numlist) /* Compute the average                 */

RETURN average

```

Summary of Subroutines and Functions

SUBROUTINES	FUNCTIONS
Invoked by using the CALL instruction followed by the subroutine name and optionally up to 20 arguments.	Invoked by specifying the function's name immediately followed by parentheses that optionally contain up to 20 arguments.

Summary of Subroutines and Functions

SUBROUTINES	FUNCTIONS
<p>Can be internal or external</p> <p>Internal</p> <ul style="list-style-type: none"> - Can pass information by using common variables - Can protect variables with the PROCEDURE instruction - Can pass information by using arguments <p>External</p> <ul style="list-style-type: none"> - Must pass information by using arguments - Can use the ARG instruction or the ARG built-in function to receive arguments 	<p>Can be internal or external</p> <p>Internal</p> <ul style="list-style-type: none"> - Can pass information by using common variables - Can protect variables with the PROCEDURE instruction - Can pass information by using arguments <p>External</p> <ul style="list-style-type: none"> - Must pass information by using arguments - Can use the ARG instruction or the ARG built-in function to receive arguments
Uses the RETURN instruction to return to the caller.	Uses the RETURN instruction to return to the caller.
<i>Might</i> return a value to the caller.	<i>Must</i> return a value to the caller.
Returns a value by placing it into the REXX special variable RESULT.	Returns a value by replacing the function call with the value.

Chapter 7. Manipulating Data

Using Compound Variables and Stems	85
What is a Compound Variable?	85
Using Stems	86
Exercises - Using Compound Variables and Stems	87
Parsing Data.	87
Instructions that Parse	88
PULL Instruction	88
ARG Instruction	88
PARSE VAR Instruction.	89
PARSE VALUE ... WITH Instruction	89
Ways of Parsing	89
Blank	89
String	90
Variable	90
Number	90
Parsing Multiple Strings as Arguments	92
Exercise - Practice with Parsing	93

This chapter describes how to use compound variables and stems, and shows various ways of parsing using templates.

Using Compound Variables and Stems

Sometimes it is useful to store groups of related data in such a way that the data can be easily retrieved. For example, a list of employee names can be stored in an array and retrieved by number. An array is an arrangement of elements in one or more dimensions, identified by a single name. You could have an array called `employee` that contains names as follows:

```
EMPLOYEE
(1) Adams, Joe
(2) Crandall, Amy
(3) Devon, David
(4) Garrison, Donna
(5) Leone, Mary
(6) Sebastian, Isaac
```

In some computer languages, you access an element in the array by the number of the element, such as, `employee(1)`, which retrieves Adams, Joe. In REXX, you use compound variables.

What is a Compound Variable?

Compound variables are a way to create a one-dimensional array or a list of variables in REXX. Subscripts do not necessarily have to be numeric. A compound variable contains at least one period with characters on both sides of it. The following are examples of compound variables.

```
FRED.5
Array.Row.Col
employee.name.phone
```

The first variable in a compound variable always remains a symbol with no substitution. The remaining variables in a compound variable take on values previously assigned. If no value was previously assigned, the variable takes on the uppercase value of the variable name.

Using Compound Variables and Stems

```
first = 'Fred'
last = 'Higgins'
employee = first.last
/* EMPLOYEE is assigned FIRST.Higgins */
SAY employee.first.middle.last
/* Displays EMPLOYEE.Fred.MIDDLE.Higgins */
```

You can use a DO loop to initialize a group of compound variables and set up an array.

```
DO i = 1 TO 6
  SAY 'Enter an employee name.'
  PARSE PULL employee.i
END
```

If you entered the same names used in the previous example of an array, you would have a group of compound variables as follows:

```
employee.1 = 'Adams, Joe'
employee.2 = 'Crandall, Amy'
employee.3 = 'Devon, David'
employee.4 = 'Garrison, Donna'
employee.5 = 'Leone, Mary'
employee.6 = 'Sebastian, Isaac'
```

When the names are in the group of compound variables, you can easily access a name by its number, or by a variable that represents its number.

```
name = 3
SAY employee.name /* Displays 'Devon, David' */
```

For more information about compound variables, see *z/OS TSO/E REXX Reference*.

Using Stems

When working with compound variables, it is often useful to initialize an entire collection of variables to the same value. You can do this easily with a **stem**. A stem is the first variable name and first period of the compound variable. Thus every compound variable begins with a stem. The following are stems:

```
FRED.
Array.
employee.
```

You can alter all the compound variables in an array through the stem. For example, to change all employee names to Nobody, issue the following assignment instruction:

```
employee. = 'Nobody'
```

As a result, all compound variables beginning with employee., whether or not they were previously assigned, return the value Nobody. Compound variables that are assigned after the stem assignment are not affected.

```
SAY employee.5 /* Displays 'Nobody' */
SAY employee.10 /* Displays 'Nobody' */
SAY employee.oldest /* Displays 'Nobody' */

employee.new = 'Clark, Evans'
SAY employee.new /* Displays 'Clark, Evans' */
```

You can use stems with the EXECIO command when reading to and writing from a data set. For information about the EXECIO command, see “Using EXECIO to Process Information to and from Data Sets” on page 154. You can also use stems

Using Compound Variables and Stems

with the OUTTRAP external function when trapping command output. For information about OUTTRAP, see “Using the OUTTRAP Function” on page 123.

Exercises - Using Compound Variables and Stems

1. After these assignment instructions, what is displayed in the following SAY instructions?

```
a = 3                               /* assigns '3' to variable 'A' */
b = 4                               /*      '4' to      'B' */
c = 'last'                          /*      'last' to      'C' */
a.b = 2                             /*      '2' to      'A.4' */
a.c = 5                             /*      '5' to      'A.last' */
x.a.b = 'cv3d'                      /*      'cv3d' to      'X.3.4' */
```

- SAY a
 - SAY B
 - SAY c
 - SAY a.a
 - SAY A.B
 - SAY b.c
 - SAY c.a
 - SAY a.first
 - SAY x.a.4
2. After these assignment instructions, what is displayed?

```
hole.1 = 'full'
hole. = 'empty'
hole.s = 'full'
```

- SAY hole.1
- SAY hole.s
- SAY hole.mouse

ANSWERS

- 3
 - 4
 - last
 - A.3
 - 2
 - B.last
 - C.3
 - A.FIRST
 - cv3d
- empty
 - full
 - empty

Parsing Data

Parsing in REXX is separating data into one or more variable names. An exec can parse an argument to break it up into smaller parts or parse a string to assign each word to a variable name. Parsing is also useful to format data into columns.

Parsing Data

Instructions that Parse

There are several REXX instructions and variations of instructions that parse data.

PULL Instruction

In earlier chapters PULL was described as an instruction that reads input from the terminal and assigns it to one or more variables. If however, the data stack contains information, the PULL instruction takes information from the data stack; and when the data stack is empty, PULL takes information from the terminal. For information about the data stack, see “Chapter 11. Storing Information in the Data Stack” on page 135. PULL changes character information to uppercase and assigns it to one or more variable names. When PULL is followed by more than one variable, it parses the information into the available variables.

```
SAY 'What is the quote for the day?' /* user enters "Knowledge */
/* is power." */
PULL word1 word2 word3
/* word1 contains 'KNOWLEDGE' */
/* word2 contains 'IS' */
/* word3 contains 'POWER.' */
```

The PARSE PULL instruction assigns information, without altering it, to variable names.

```
SAY 'What is the quote for the day?' /* user enters "Knowledge */
/* is power." */
PARSE PULL word1 word2 word3
/* word1 contains 'Knowledge' */
/* word2 contains 'is' */
/* word3 contains 'power.' */
```

PARSE UPPER PULL causes the same result as PULL in that it changes character information to uppercase before assigning it to one or more variables.

ARG Instruction

The ARG instruction takes information passed as arguments to an exec, function, or subroutine, and puts it into one or more variable names. Before character information is put into a variable name, ARG changes it to uppercase. When ARG is followed by more than one variable name, it parses the information into the available variable names. For example, if an exec named USERID.REXX.EXEC(QUOTE) can receive arguments, you can invoke the exec with the EXEC command and the three arguments as follows:

```
EXEC rexx.exec(quote) 'Knowledge is power.' exec
```

The exec receives the arguments with the ARG instruction as follows:

```
ARG word1 word2 word3
/* word1 contains 'KNOWLEDGE' */
/* word2 contains 'IS' */
/* word3 contains 'POWER.' */
```

The PARSE ARG instruction assigns information, without altering it, to variable names.

```
PARSE ARG word1 word2 word3
/* word1 contains 'Knowledge' */
/* word2 contains 'is' */
/* word3 contains 'power.' */
```

PARSE UPPER ARG causes the same result as ARG in that it changes character information to uppercase before assigning it to one or more variables.

PARSE VAR Instruction

The PARSE VAR instruction parses a specified variable into one or more variable names that follow it. If the variable contains character information, it is not changed to uppercase.

```
quote = 'Knowledge is power.'
PARSE VAR quote word1 word2 word3
/* word1 contains 'Knowledge' */
/* word2 contains 'is' */
/* word3 contains 'power.' */
```

The PARSE UPPER VAR instruction changes character information to uppercase before putting it into the variables.

```
quote = 'Knowledge is power.'
PARSE UPPER VAR quote word1 word2 word3
/* word1 contains 'KNOWLEDGE' */
/* word2 contains 'IS' */
/* word3 contains 'POWER.' */
```

For more information about parsing instructions, see *z/OS TSO/E REXX Reference*.

PARSE VALUE ... WITH Instruction

The PARSE VALUE ... WITH instruction parses a specified expression, such as a literal string, into one or more variable names that follow the WITH subkeyword. If the literal string contains character information, it is not changed to uppercase.

```
PARSE VALUE 'Knowledge is power.' WITH word1 word2 word3
/* word1 contains 'Knowledge' */
/* word2 contains 'is' */
/* word3 contains 'power.' */
```

The PARSE UPPER VALUE instruction changes character information to uppercase before assigning it to the variable names.

```
PARSE UPPER VALUE 'Knowledge is power.' WITH word1 word2 word3
/* word1 contains 'KNOWLEDGE' */
/* word2 contains 'IS' */
/* word3 contains 'POWER.' */
```

Ways of Parsing

Parsing separates data by comparing the data to a template (or pattern of variable names). Separators in a template can be a blank, string, variable, or number that represents column position.

Blank

The simplest template is a group of variable names separated by blanks. Each variable name gets one word of data in sequence except for the last, which gets the remainder of the data. The last variable name might then contain several words and possibly leading and trailing blanks.

```
PARSE VALUE 'Value with Blanks.' WITH pattern type
/* pattern contains 'Value' */
/* type contains ' with Blanks.' */
```

When there are more variables than data, the extra variables are set to null.

```
PARSE VALUE 'Value with Extra Variables.' WITH data1 data2 data3 data4 data5
/* data1 contains 'Value' */
/* data2 contains 'with' */
/* data3 contains 'Extra' */
/* data4 contains 'Variables.' */
/* data5 contains '' */
```

Parsing Data

A period in a template acts as a place holder. The data that corresponds to the period is not assigned to a variable name. You can use a period as a "dummy variable" within a group of variables or at the end of a template to collect unwanted information.

```
PARSE VALUE 'Value with Periods in it.' WITH pattern . type .
                                     /* pattern contains 'Value'      */
                                     /* type contains 'Periods'        */
                                     /* the periods replace the words "with" and "in it." */
```

String

You can use a string in a template to separate data as long as the data includes the string as well. The string becomes the point of separation and is not included as data.

```
phrase = 'To be, or not to be?'      /* phrase containing comma */
PARSE VAR phrase part1 ', ' part2    /* template containing comma */
                                     /* as string separator      */
                                     /* part1 contains 'To be'   */
                                     /* part2 contains ' or not to be?' */
```

In this example, notice that the comma is not included with 'To be' because the comma is the string separator.

Variable

When you do not know in advance what string to specify as separator in a template, you can use a variable enclosed in parentheses. The variable value must be included in the data.

```
separator = ','
phrase = 'To be, or not to be?'
PARSE VAR phrase part1 (separator) part2
                                     /* part1 contains 'To be'      */
                                     /* part2 contains ' or not to be?' */
```

Again, in this example, notice that the comma is not included with 'To be' because the comma is the string separator.

Number

You can use numbers in a template to indicate the column at which to separate data. An unsigned integer indicates an absolute column position and a signed integer indicates a relative column position.

- Absolute column position

An unsigned integer or an integer prefixed with an equal sign (=) in a template separates the data according to absolute column position. The first segment starts at column 1 and goes up to, but does not include, the information in the column number specified. The subsequent segments start at the column numbers specified.

```
quote = 'Ignorance is bliss.'
       ....+....1....+....2

PARSE VAR quote part1 5 part2
                                     /* part1 contains 'Igno'      */
                                     /* part2 contains 'rance is bliss.' */
```

This example could have also been coded as follows. Note the explicit use of the column 1 indicator prior to *part1* that was implied in the previous example and the use of the =5 *part2* to indicate the absolute position, column 5.

```
quote = 'Ignorance is bliss.'
       ....+....1....+....2
```

```

PARSE VAR quote 1 part1 =5 part2
                /* part1 contains 'Igno'          */
                /* part2 contains 'rance is bliss.' */

```

When a template has more than one number, and a number at the end of the template is lower than an earlier number, parse loops back to the beginning of the data.

```

quote = 'Ignorance is bliss.'
        ....+....1....+....2

PARSE VAR quote part1 5 part2 10 part3 1 part4
                /* part1 contains 'Igno'          */
                /* part2 contains 'rance'         */
                /* part3 contains ' is bliss.'     */
                /* part4 contains 'Ignorance is bliss.' */

```

When each variable in a template has column numbers both before and after it, the two numbers indicate the beginning and the end of the data for the variable.

```

quote = 'Ignorance is bliss.'
        ....+....1....+....2

PARSE VAR quote 1 part1 10 11 part2 13 14 part3 19 1 part4 20
                /* part1 contains 'Ignorance'     */
                /* part2 contains 'is'            */
                /* part3 contains 'bliss'         */
                /* part4 contains 'Ignorance is bliss.' */

```

- Relative column position

A signed integer in a template separates the data according to relative column position, that is, a starting position relative to the starting position of the preceding part. A signed integer can be either positive (+) or negative (-) causing the part to be parsed to shift either to the right (with a +) or to the left (with a -). *part1* starts at column 1, the preceding 1 is not coded but implied. In the following example, therefore, the *+5 part2* causes part2 to start in column 1+5=6, the *+5 part3* causes part3 to start in column 6+5=11, and so on.

```

quote = 'Ignorance is bliss.'
        ....+....1....+....2

PARSE VAR quote part1 +5 part2 +5 part3 +5 part4
                /* part1 contains 'Ignor'        */
                /* part2 contains 'ance '       */
                /* part3 contains 'is bl'      */
                /* part4 contains 'iss.'       */

```

The use of the minus sign is similar to the use of the plus sign in that it is used to identify a relative position in the data string. The minus sign is used to “back up” (move to the left) in the data string. In the following example, therefore, the *part1* causes part1 to start in column 1 (implied), the *+10 part2* causes part2 to start in column 1+10=11, the *+3 part3* causes part3 to start in column 11+3=14, and the *-3 part4* causes part4 to start in column 14-3=11.

```

quote = 'Ignorance is bliss.'
        ....+....1....+....2

PARSE VAR quote part1 +10 part2 +3 part3 -3 part4
                /* part1 contains 'Ignorance '   */
                /* part2 contains 'is '         */
                /* part3 contains 'bliss.'      */
                /* part4 contains 'is bliss.'   */

```

- Variables

Parsing Data

You can define and use variables to provide further flexibility of a PARSE VAR instruction. Define the variable prior to the parse instruction, such as the movex variable in the following example. With the PARSE instruction, enclose the variable in parenthesis, in place of a number. This variable *must be an unsigned integer*. Therefore, use a sign outside the parenthesis to indicate how REXX is to interpret the unsigned integer. REXX substitutes the numeric value for the variable as follows:

```
quote = 'Ignorance is bliss.'
      ....+....1....+....2

movex = 3
PARSE VAR quote part5 +10 part6 +3 part7 -(movex) part8
      /* part5 contains 'Ignorance ' */
      /* part6 contains 'is ' */
      /* part7 contains 'bliss.' */
      /* part8 contains 'is bliss.' */
```

Note: The variable movex in the previous example must be an unsigned integer. Always code a sign prior to the parenthesis to indicate how the integer is to be interpreted. If you do not, the variable will be interpreted as a string separator. Valid signs are:

- A plus sign (+) indicates column movement to the right
- A minus sign (-) indicates column movement to the left
- An equal sign (=) indicates an absolute column position.

For more information about parsing, see *z/OS TSO/E REXX Reference*.

Parsing Multiple Strings as Arguments

When passing arguments to a function or a subroutine, you can specify multiple strings to be parsed. Arguments are parsed with the ARG, PARSE ARG, and PARSE UPPER ARG instructions.

To pass multiple strings, separate each string with a comma. This comma is not a string separator as illustrated in the example on page 90, although you can also use a string separator within an argument template.

The following example passes three arguments separated by commas to an internal subroutine. The first argument consists of two words "String One" that are parsed into three variable names. The third variable name is set to null because there is no third word. The second and third arguments are parsed entirely into variable names string2 and string3.

```
CALL sub2 'String One', 'String Two', 'String Three'
      :
      :

EXIT

sub2:
PARSE ARG word1 word2 word3, string2, string3
      /* word1 contains 'String' */
      /* word2 contains 'One' */
      /* word3 contains '' */
      /* string2 contains 'String Two' */
      /* string3 contains 'String Three' */
```

For more information about passing multiple arguments, see *z/OS TSO/E REXX Reference*.

Exercise - Practice with Parsing

What are the results of the following parsing examples?

1. quote = 'Experience is the best teacher.'
 PARSE VAR quote word1 word2 word3
 a) word1 =
 b) word2 =
 c) word3 =
2. quote = 'Experience is the best teacher.'
 PARSE VAR quote word1 word2 word3 word4 word5 word6
 a) word1 =
 b) word2 =
 c) word3 =
 d) word4 =
 e) word5 =
 f) word6 =
3. PARSE VALUE 'Experience is the best teacher.' WITH word1 word2 . . word3
 a) word1 =
 b) word2 =
 c) word3 =
4. PARSE VALUE 'Experience is the best teacher.' WITH v1 5 v2
+....1....+....2....+....3.
 a) v1 =
 b) v2 =
5. quote = 'Experience is the best teacher.'
+....1....+....2....+....3.

 PARSE VAR quote v1 v2 15 v3 3 v4
 a) v1 =
 b) v2 =
 c) v3 =
 d) v4 =
6. quote = 'Experience is the best teacher.'
+....1....+....2....+....3.

 PARSE UPPER VAR quote 15 v1 +16 =12 v2 +2 1 v3 +10
 a) v1 =
 b) v2 =
 c) v3 =
7. quote = 'Experience is the best teacher.'
+....1....+....2....+....3.

 PARSE VAR quote 1 v1 +11 v2 +6 v3 -4 v4
 a) v1 =
 b) v2 =
 c) v3 =
 d) v4 =
8. first = 7
 quote = 'Experience is the best teacher.'
+....1....+....2....+....3.

 PARSE VAR quote 1 v1 =(first) v2 +6 v3
 a) v1 =
 b) v2 =
 c) v3 =
9. quote1 = 'Knowledge is power.'
 quote2 = 'Ignorance is bliss.'
 quote3 = 'Experience is the best teacher.'
 CALL sub1 quote1, quote2, quote3
 EXIT

Parsing Data

```
sub1:
PARSE ARG word1 . . , word2 . . , word3 .
a) word1 =
b) word2 =
c) word3 =
```

ANSWERS

1.
 - a) word1 = Experience
 - b) word2 = is
 - c) word3 = the best teacher.
2.
 - a) word1 = Experience
 - b) word2 = is
 - c) word3 = the
 - d) word4 = best
 - e) word5 = teacher.
 - f) word6 = "
3.
 - a) word1 = Experience
 - b) word2 = is
 - c) word3 = teacher.
4.
 - a) v1 = Expe
 - b) v2 = rience is the best teacher.
5.
 - a) v1 = Experience
 - b) v2 = is
 - c) v3 = the best teacher.
 - d) v4 = perience is the best teacher.
6.
 - a) v1 = THE BEST TEACHER
 - b) v2 = IS
 - c) v3 = EXPERIENCE
7.
 - a) v1 = 'Experience '
 - b) v2 = 'is the'
 - c) v3 = ' best teacher.'
 - d) v4 = ' the best teacher.'
8.
 - a) v1 = 'Experi'
 - b) v2 = 'ence i'
 - c) v3 = 's the best teacher.'
9.
 - a) word1 = Knowledge
 - b) word2 = Ignorance
 - c) word3 = Experience

Part 2. Using REXX

In addition to being a versatile general-purpose programming language, REXX can interact with TSO/E, MVS, APPC/MVS, and ISPF, which expands its capabilities. This part of the book is for programmers already familiar with the REXX language and experienced in TSO/E. The chapters in this part cover the following topics.

- “Chapter 8. Entering Commands from an Exec” on page 97 — A REXX exec can issue different types of host commands within the same exec.
- “Chapter 9. Diagnosing Problems Within an Exec” on page 111 — Several debugging options are available in an exec.
- “Chapter 10. Using TSO/E External Functions” on page 119 — TSO/E external functions are provided to interact with the system to do specific tasks.
- “Chapter 11. Storing Information in the Data Stack” on page 135 — The data stack is useful in I/O and other types of special processing.
- “Chapter 12. Processing Data and Input/Output Processing” on page 153 — You can process information to and from data sets by using the EXECIO command.
- “Chapter 13. Using REXX in TSO/E and Other MVS Address Spaces” on page 171 — You can run execs in other MVS address spaces besides TSO/E foreground and background.

Note: Although you can write a REXX exec to run in a non-TSO/E address space in MVS, the chapters and examples in this part, unless otherwise stated, assume the exec will run in a TSO/E address space. If you want to write execs that run outside of a TSO/E address space, keep in mind the following exceptions to information in this part of the book.

- An exec that runs outside of a TSO/E address space cannot include TSO/E commands, ISPF commands, or ISPF/PDF edit commands. An exec that runs outside of a TSO/E address space can include TSO/E commands if you use the TSO/E environment service (see note).
- An exec that runs outside of TSO/E cannot include most of the TSO/E external functions. For information about the functions you can use in TSO/E and non-TSO/E address spaces, see “Services Available to REXX Execs” on page 171.
- In TSO/E, several REXX instructions either display information on the terminal or retrieve information that the user enters at the terminal. In a non-TSO/E address space, these instructions get information from the input stream and write information to the output stream.
 - SAY — this instruction sends information to the output DD whose default is SYSTSPRT.
 - PULL — this instruction gets information from the input DD whose default is SYSTSIN.
 - TRACE — this instruction sends information to the output DD whose default is SYSTSPRT.
 - PARSE EXTERNAL — this instruction gets information from the input DD whose default is SYSTSIN.
- An exec that runs outside of TSO/E cannot interact with CLISTs.

Note: You can use the TSO/E environment service, IKJTSOEV, to create a TSO/E environment in a non-TSO/E address space. If you run a REXX exec in the TSO/E environment you created, the exec can contain TSO/E commands, external functions, and services that an exec running in a TSO/E address space can use. That is, the TSO host command environment (ADDRESS

TSO) is available to the exec with some limitations. For more information about the TSO/E environment service, limitations on the environment it creates, and the different considerations for running REXX execs within the environment, see *z/OS TSO/E Programming Services*.

Chapter 8. Entering Commands from an Exec

Types of Commands	97
Issuing TSO/E Commands from an Exec	98
Using Quotations Marks in Commands	98
Passing Data Set Names as Arguments.	98
Using Variables in Commands	99
Causing Interactive Commands to Prompt the User	100
Invoking Another Exec as a Command.	100
Invoking Another Exec with the EXEC Command.	101
Invoking Another Exec Implicitly	101
Issuing Other Types of Commands from an Exec.	101
What is a Host Command Environment?	101
APPC/MVS Host Command Environments	104
Examples Using APPC/MVS Services	106
Changing the Host Command Environment	106
Determining the Active Host Command Environment	107
Checking if a Host Command Environment is Available	107
Examples Using the ADDRESS Instruction	107

This chapter describes how to issue TSO/E commands and other types of commands from a REXX exec.

Types of Commands

A REXX exec can issue many types of commands. The two main categories of commands are:

- TSO/E REXX commands - Commands provided with the TSO/E implementation of the language. These commands do REXX-related tasks in an exec, such as:
 - Control I/O processing of information to and from data sets (EXECIO)
 - Perform data stack services (MAKEBUF, DROPBUF, QBUF, QELEM, NEWSTACK, DELSTACK, QSTACK)
 - Change characteristics that control the execution of an exec (EXECUTIL and the immediate commands)
 - Check for the existence of a host command environment (SUBCOM).

More information about these TSO/E REXX commands appears throughout the book where the related task is discussed

- Host commands - The commands recognized by the host environment in which an exec runs. A REXX exec can issue various types of host commands as discussed in the remainder of this chapter.

When an exec issues a command, the REXX special variable RC is set to the return code. An exec can use the return code to determine a course of action within the exec. Every time a command is issued, RC is set. Thus RC contains the return code from the most recently issued command.

Issuing TSO/E Commands from an Exec

Like a CLIST, a REXX exec can contain TSO/E commands to be executed when the exec runs. An exec can consist of nothing but TSO/E commands, such as an exec that sets up a user's terminal environment by allocating the appropriate libraries of data sets, or the exec can contain commands intermixed with REXX language instructions.

Using Quotations Marks in Commands

Generally, to differentiate commands from other types of instructions, enclose the command within single or double quotation marks. When issuing TSO/E commands in an exec, it is recommended that you enclose them in double quotation marks. If the command is not enclosed within quotation marks, it will be processed as an expression and might end in error. For example, a word immediately followed by a left parenthesis is processed by the language processor as a function call. Several TSO/E commands, one of which is ALLOCATE, require keywords followed by parentheses.

```
"ALLOC DA(NEW.DATA) LIKE(OLD.DATA) NEW"
```

If the ALLOCATE command in the example above was not enclosed in quotation marks, the parentheses would indicate to the language processor that DA and LIKE were function calls, and the command would end in an error.

Many TSO/E commands use single quotation marks within the command. For example, the EXEC command encloses an argument within single quotation marks, and other commands, such as ALLOCATE, require single quotation marks around fully-qualified data set names.

```
EXEC myrexx.exec(add) '25 78 33' exec
```

```
ALLOC DA('USERID.MYREXX.EXEC') F(SYSEXEC) SHR REUSE
```

As REXX instructions, these commands can be entirely enclosed in double quotation marks and still retain the single quotation marks for the specific information within the command. For this reason, it is recommended that, as a matter of course, you enclose TSO/E commands with double quotation marks.

```
"EXEC myrexx.exec(add) '25 78 33' exec"
```

```
"ALLOC DA('USERID.MYREXX.EXEC') F(SYSEXEC) SHR REUSE"
```

Remember that data set names beginning with your prefix (usually your user ID) can be specified without the prefix and without quotation marks.

```
"ALLOC DA(MYREXX.EXEC) F(SYSEXEC) SHR REUSE"
```

More about data sets names and when to enclose them in quotation marks is covered in the next topic.

Passing Data Set Names as Arguments

How you pass a data set name as an argument depends on the way you specify the data set name and whether you invoke the exec explicitly or implicitly.

Ways to specify the data set name are controlled by the TSO/E naming conventions, which define fully-qualified and non fully-qualified data sets. A fully-qualified data set name specifies all three qualifiers including the prefix and must appear within a set of quotation marks.

```
'userid.myrexx.exec'
```

Issuing TSO/E Commands from an Exec

A non fully-qualified data set name can eliminate the prefix and is not enclosed within quotation marks.

```
myrexx.exec
```

If you use the EXEC command to *explicitly* invoke an exec, the EXEC command processor requires a set of single quotation marks around the argument. When passing a non fully-qualified data set name as an argument, you need not add additional quotation marks. The following EXEC command is issued at the READY prompt and passes the data set name REXX.INPUT as an argument to the exec contained in MYREXX.EXEC(TEST2). Both data sets are specified as non fully-qualified data set names.

```
READY  
EXEC myrexx.exec(test2) 'rexx.input' exec
```

When passing a fully-qualified data set name as an argument with the EXEC command, you must include more than one set of quotation marks; one to indicate it is a fully-qualified data set and one to indicate it is the argument to be passed. Because TSO/E commands process two sets of single quotation marks as one and do not recognize double quotation marks as does the language processor, you must use three sets of single quotation marks. The following EXEC command passes USERID.REXX.INPUT as an argument expressed as a fully-qualified data set name.

```
READY  
EXEC myrexx.exec(test2) 'userid.rexx.input'' exec
```

When passing a non fully-qualified data set name as an argument while *implicitly* invoking the exec, you need no quotation marks.

```
READY  
test2 rexx.input
```

To pass a fully-qualified data set name as an argument while implicitly invoking an exec, enclose the data set name in a single set of quotation marks.

```
READY  
test2 'userid.rexx.input'
```

Using Variables in Commands

When a variable is used in a TSO/E command, the variable cannot be within quotation marks if its value is to be substituted. Only variables outside quotation marks are processed by the language processor. For example, the variable name is assigned the data set name MYREXX.EXEC. When name is used in a LISTDS command, it must remain outside the quotation marks placed around the command.

```
name = myrexx.exec  
"LISTDS" name "STATUS"
```

When a variable represents a fully-qualified data set name, the name must be enclosed in two sets of quotation marks to ensure that one set of quotation marks remains as part of the value.

```
name = "'project.re11.new'"  
"LISTDS" name "STATUS"
```

Another way to ensure that quotation marks appear around a fully-qualified data set name when it appears as a variable is to include them as follows:

```
name = project.re11.new  
"LISTDS '"name"' STATUS"
```

Issuing TSO/E Commands from an Exec

Causing Interactive Commands to Prompt the User

If your TSO/E profile allows prompting, when you issue an interactive command without operands, you are prompted for operands. For example, when you issue the LISTDS command from READY, you are prompted for a data set name.

```
READY
listds
ENTER DATA SET NAME -
```

To have TSO/E commands prompt you when the commands are issued from within an exec, you can do one of two things:

- Run the exec explicitly with the EXEC command and use the PROMPT operand.

```
EXEC mynew.exec(create) exec prompt
```

- Use the PROMPT function within the exec. Because PROMPT is a function, it is used as an expression within an instruction, such as an assignment instruction or a SAY instruction. To turn prompting on, write:

```
saveprompt = PROMPT('ON') /* saveprompt is set to the previous
                             setting of PROMPT */
```

To turn prompting off, write:

```
x = PROMPT('OFF') /* x is set to the previous setting of PROMPT */
```

To find out the prompting status, write:

```
SAY PROMPT() /* displays either "ON" or "OFF" */
```

To reset prompting to a specific setting saved in variable *saveprompt*, write:

```
x = prompt(saveprompt)
```

Important Note

Neither of these options can override a NOPROMPT operand in your TSO/E profile. Your TSO/E profile controls prompting for all commands issued in your TSO/E session whether the commands are issued in line mode, in ISPF, in an exec, or in a CLIST. To display your profile, issue the PROFILE command. To change a profile from NOPROMPT to PROMPT, issue:

```
PROFILE PROMPT
```

Prompting by commands also depends on whether there are elements in the data stack. If the data stack contains an element, the user at the terminal is not prompted because the data stack element is used in response to the prompt. For more information about the data stack, see “Chapter 11. Storing Information in the Data Stack” on page 135.

Invoking Another Exec as a Command

Previously, this book discussed how to invoke another exec as an external routine (“Chapter 6. Writing Subroutines and Functions” on page 69). You can also invoke an exec from another exec explicitly with the EXEC command or implicitly by member name. Like an external routine, an exec invoked explicitly or implicitly can return a value to the caller with the RETURN or EXIT instruction. Unlike an external routine, which passes a value to the special variable RESULT, the invoked exec passes a value to the REXX special variable RC.

Invoking Another Exec with the EXEC Command

To explicitly invoke another exec from within an exec, issue the EXEC command as you would any other TSO/E command. The called exec should end with a RETURN or EXIT instruction, ensuring that control returns to the caller. The REXX special variable RC is set to the return code from the EXEC command. You can optionally return a value to the caller on the RETURN or EXIT instruction. When control passes back to the caller, the REXX special variable RC is set to the value of the expression returned on the RETURN or EXIT instruction.

For example, to invoke an exec named MYREXX.EXEC(CALC) and pass it an argument of four numbers, you could include the following instructions:

```
"EXEC myrexx.exec(calc) '24 55 12 38' exec"  
SAY 'The result is' RC
```

'Calc' might contain the following instructions:

```
ARG number1 number2 number3 number4  
answer = number1 * (number2 + number3) - number4  
RETURN answer
```

You might want to invoke an exec with the EXEC command rather than as an external routine when the exec is not within the same PDS as the calling exec, or when the PDSs of the two execs are not allocated to either SYSEXEC or SYSPROC.

Invoking Another Exec Implicitly

To implicitly invoke another exec from within an exec, type the member name either with or without %. Because it is treated as a command, enclose the member name and the argument, if any, within quotation marks. As with any other implicitly invoked exec, the PDSs containing the calling exec and the called exec must be allocated to either SYSEXEC or SYSPROC. Remember that a % before the member name reduces the search time because fewer files are searched.

For example, to implicitly invoke an exec named MYREXX.EXEC(CALC) and send it an argument of four numbers, you could include the following instructions.

```
"%calc 24 55 12 38"  
SAY 'The result is' RC
```

'Calc' might contain the following instructions:

```
ARG number1 number2 number3 number4  
answer = number1 * (number2 + number3) - number4  
RETURN answer
```

Issuing Other Types of Commands from an Exec

A REXX exec in TSO/E can issue TSO/E commands, APPC/MVS calls, MVS module invocations, ISPF commands, and ISPF/PDF EDIT commands. If you have TSO/E CONSOLE command authority and an extended MCS console session is active, you can also issue MVS system and subsystem commands in a REXX exec. Each type of invocation is associated with a different *host command environment*.

What is a Host Command Environment?

An environment for executing commands is called a host command environment. Before an exec runs, an active host command environment is defined to handle commands issued by the exec. When the language processor encounters a command, it passes the command to the host command environment for processing.

Issuing Other Types of Commands from an Exec

When a REXX exec runs on a host system, there is at least one default environment available for executing commands.

The default host command environments available in TSO/E REXX are as follows:

TSO - the environment in which TSO/E commands and TSO/E REXX commands execute in the TSO/E address space.

MVS - the environment in which TSO/E REXX commands execute in a non-TSO/E address space.

LINK - an environment that links to modules on the same task level.

LINKMVS - an environment that links to modules on the same task level. This environment allows you to pass multiple parameters to an invoked module, and allows the invoked module to update the parameters. The parameters you pass to the module include a length identifier.

LINKPGM - an environment that links to modules on the same task level. This environment allows you to pass multiple parameters to an invoked module, and allows the invoked module to update the parameters. The parameters you pass to the module do not include a length identifier.

ATTACH - an environment that attaches modules on a different task level.

ATTCHMVS - an environment that attaches modules on a different task level. This environment allows you to pass multiple parameters to an invoked module, and allows the invoked module to update the parameters. The parameters you pass to the module include a length identifier.

ATTCHPGM - an environment that attaches modules on a different task level. This environment allows you to pass multiple parameters to an invoked module, and allows the invoked module to update the parameters. The parameters you pass to the module do not include a length identifier.

ISPEXEC - the environment in which ISPF commands execute.

ISREDIT - the environment in which ISPF/PDF EDIT commands execute.

CONSOLE - the environment in which MVS system and subsystem commands execute. To use the CONSOLE environment, you must have TSO/E CONSOLE command authority and an extended MCS console session must be active. You use the TSO/E CONSOLE command to activate an extended MCS console session. See *z/OS TSO/E System Programming Command Reference*, for more information about using the CONSOLE command.

CPICOMM - the environment that allows you to invoke the SAA common programming interface (CPI) Communications calls.

LU62 - the environment that allows you to invoke the APPC/MVS calls that are based on the SNA LU 6.2 architecture. These calls are referred to as APPC/MVS calls throughout the book.

APPCMVS - the environment that allows you to access MVS/APPC callable services related to server facilities and for the testing of transaction programs.

In a non-TSO/E environment, TSO/E REXX provides the following host command environments:

- MVS (the initial host command environment)
- LINK
- LINKMVS
- LINKPGM
- ATTACH
- ATTCHMVS
- ATTCHPGM

Issuing Other Types of Commands from an Exec

- CPICOMM
- LU62
- APPCMVS

From TSO/E READY mode, TSO/E REXX provides the following host command environments:

- TSO (the initial host command environment)
- MVS
- LINK
- LINKMVS
- LINKPGM
- ATTACH
- ATTCHMVS
- ATTCHPGM
- CONSOLE
- CPICOMM
- LU62
- APPCMVS

In ISPF, TSO/E REXX provides the following host command environments:

- TSO (the initial host command environment)
- MVS
- LINK
- LINKMVS
- LINKPGM
- ATTACH
- ATTCHMVS
- ATTCHPGM
- ISPEXEC
- ISREDIT
- CONSOLE
- CPICOMM
- LU62
- APPCMVS

Note: These lists of host command environments represent the defaults. Your installation may have added or deleted environments.

The default host command environment for execs running in TSO/E and ISPF is TSO. Thus all commands are sent to TSO/E for processing, unless the exec changes the host command environment.

When an exec runs in an MVS environment, TSO/E command processors and services are not available to it. For more information, see “Services Available to REXX Execs” on page 171. In an MVS host command environment, you can issue many of the TSO/E REXX commands, such as EXECIO, MAKEBUF, and NEWSTACK.

Issuing Other Types of Commands from an Exec

APPC/MVS Host Command Environments

The CPICOMM environment enables you to invoke the SAA CPI Communications calls and the LU62 and APPCMVS environments enable you to invoke APPC/MVS calls. You can write transaction programs in the REXX language, using the LU62, CPICOMM, or APPCMVS host command environments, to issue APPC calls to a partner transaction program. The CPICOMM host command environment allows transaction programs written in the REXX language to be ported across SAA environments. The LU62 host command environment allows you to use specific features of MVS in conversations with transaction programs on other systems. APPCMVS allows you to access APPC/MVS callable services related to server facilities and for the testing of transaction programs. Each of these host command environments enable REXX programs to communicate with other programs on the same MVS system, different MVS systems, or different operating systems in an SNA network.

The following APPC/MVS calls are supported under the APPCMVS host command environment:

- ATBCUC1 (Cleanup_TP(Unauthorized))
- ATBGTE2 (Get_Event)
- ATBPOR2 (Post_on_Receipt)
- ATBQAQ2 (Query_Allocate_Query)
- ATBRAL2 (Receive_Allocate)
- ATBRFA2 (Register_for_Allocate)
- ATBRJC2 (Reject_Conversation)
- ATBSAQ2 (Set_Allocate_Queue_Attributes)
- ATBSCA2 (Set_Conversation_Accounting_Information)
- ATBSTE2 (Set_Event_Notification)
- ATBTEA1 (Accept_Test)
- ATBTER1 (Register_Test)
- ATBTEU1 (Unregister_Test)
- ATBURA2 (Unregister_for_Allocates)
- ATBVERS (MVS_Version_Check)

The following SAA CPI Communications calls are supported under the CPICOMM host command environment:

- CMACCP (Accept_Conversation)
- CMALLC (Allocate)
- CMCFM (Confirm)
- CMCFMD (Confirmed)
- CMDEAL (Deallocate)
- CMECS (Extract_Conversation_State)
- CMECT (Extract_Conversation_Type)
- CMEMN (Extract_Mode_Name)
- CMEPLN (Extract_Partner_LU_Name)
- CMESL (Extract_Sync_Level)
- CMFLUS (Flush)
- CMINIT (Initialize_Conversation)
- CMPTR (Prepare_To_Receive)
- CMRCV (Receive)

Issuing Other Types of Commands from an Exec

- CMRTS (Request_To_Send)
- CMSCT (Set_Conversation_Type)
- CMSDT (Set_Deallocate_Type)
- CMSED (Set_Error_Direction)
- CMSEND (Send_Data)
- CMSERR (Send_Error)
- CMSF (Set_Fill)
- CMSLD (Set_Log_Data)
- CMSMN (Set_Mode_Name)
- CMSPLN (Set_Partner_LU_Name)
- CMSPTR (Set_Prepare_To_Receive_Type)
- CMSRC (Set_Return_Control)
- CMSRT (Set_Receive_Type)
- CMSSL (Set_Sync_Level)
- CMSST (Set_Send_Type)
- CMSTPN (Set_TP_Name)
- CMTRTS (Test_Request_To_Send_Received)

The SAA CPI Communications calls are described in *SAA Common Programming Interface Communications Reference*.

The following APPC/MVS calls are supported under the LU62 host command environment:

- ATBALC2 (Allocate)
- ATBALLC (Allocate)
- ATBCFM (Confirm)
- ATBCFMD (Confirmed)
- ATBDEAL (Deallocate)
- ATBFLUS (Flush)
- ATBGETA (Get_Attributes)
- ATBGETC (Get_Conversation)
- ATBGETP (Get_TP_Properties)
- ATBGETT (Get_Type)
- ATBGTA2 (Get_Attribute)
- ATBPTR (Prepare_To_Receive)
- ATBRCVI (Receive_Immediate)
- ATBRCVW (Receive_And_Wait)
- ATBRTS (Request_To_Send)
- ATBSEND (Send_Data)
- ATBSERR (Send_Error)

Note: The numeric suffix within the service name indicates the MVS release in which the service was introduced and thereby also available in all subsequent releases, as follows:

- none** MVS SP4.2 service. For example, ATBGETA
- 1** MVS SP4.2.2 service. For example, ATBTEA1

Issuing Other Types of Commands from an Exec

2 MVS SP4.3 service. For example, ATBALC2

Therefore, your z/OS base control program (BCP) must be at least at the indicated level to take advantage of these services.

The parameters for these services and the requirements for using them in APPC/MVS transaction programs are described in *z/OS MVS Programming: Writing Transaction Programs for APPC/MVS*.

Examples Using APPC/MVS Services

The following example illustrates the syntax for invoking an SAA CPI Communications call under the CPICOMM host command environment:

CPICOMM Example

```
/* REXX */
ADDRESS CPICOMM 'CMALLC conversation_id return_code'
if return_code = CM_OK then say 'OK!'
                    else say 'Why not?'
```

The following example illustrates the syntax for invoking an APPC/MVS call under the LU62 host command environment:

LU62 Example

```
/* REXX */
ADDRESS LU62 'ATBDEAL conversation_id deallocate_type',
            'notify_type return_code'
```

Whenever you issue an SAA CPI Communications call or APPC/MVS call from a REXX program, the entire call must be enclosed in single or double quotes.

SAA CPI Communications calls and APPC/MVS calls can use pseudonyms rather than integer values. In the CPICOMM example, instead of comparing the variable `return_code` to an integer value of 0, the example compares `return_code` to the pseudonym value `CM_OK`. The integer value for `CM_OK` is 0. TSO/E provides two pseudonym files, one for the LU62 host command environment and one for the CPICOMM host command environment. These files define the pseudonyms and their integer values. The LU62 pseudonym file is `REXAPPC1`, and the CPICOMM pseudonym file is `REXAPPC2`. Both files are found in `SYS1.SAMPLIB`. You can include this information from the pseudonym files in your REXX execs.

For more information about host command environments and pseudonym files, refer to *z/OS TSO/E REXX Reference*.

Changing the Host Command Environment

You can change the host command environment either from the default or from whatever environment was previously established. To change the host command environment, use the `ADDRESS` instruction followed by the name of an environment.

The `ADDRESS` instruction has two forms: one affects all commands issued after the instruction, and one affects only a single command.

- **All commands**

Issuing Other Types of Commands from an Exec

When an ADDRESS instruction includes only the name of the host command environment, all commands issued afterward within that exec are processed as that environment's commands.

```
ADDRESS ispexec /* Change the host command environment to ISPF */
"edit DATASET("dsname")"
```

The ADDRESS instruction affects only the host command environment of the exec that uses the instruction. When an exec calls an external routine, the host command environment reverts back to the default environment, regardless of the host command environment of the exec that called it. Upon return to the original exec, the host command environment that was previously established by an ADDRESS instruction is resumed.

- **Single command**

When an ADDRESS instruction includes both the name of the host command environment and a command, only that command is affected. After the command is issued, the former host command environment becomes active again.

```
/* Issue one command from the ISPF host command environment */
ADDRESS ispexec "edit DATASET("dsname")"
/* Return to the default TSO host command environment */
"ALLOC DA("dsname") F(SYSEXEC) SHR REUSE"
```

Note: Keywords, such as DATASET, within an ISPF command must be in uppercase when used in a REXX instruction.

Determining the Active Host Command Environment

To find out what host command environment is currently active, use the ADDRESS built-in function.

```
x = ADDRESS()
```

In this example, x is set to the active host command environment, for example, TSO.

Checking if a Host Command Environment is Available

To check if a host command environment is available before trying to issue commands to that environment, issue the TSO/E REXX SUBCOM command followed by the name of the host command environment, such as ISPEXEC.

```
SUBCOM ISPEXEC
```

If the environment is present, the REXX special variable RC returns a 0. If the environment is not present, RC returns a 1. For example, when editing a data set, before trying to use ISPF/PDF edit, you can find out if ISPEXEC is available as follows:

```
ARG dsname
SUBCOM ISPEXEC
IF RC=0 THEN
  ADDRESS ISPEXEC "SELECT PGM(ISREDIT)" /* select ISPF/PDF edit */
ELSE
  "EDIT" dsname /* use TSO/E line mode edit */
```

Examples Using the ADDRESS Instruction

Issuing Other Types of Commands from an Exec

ADDRESS Example 1

```
/****** REXX ******/
/* This exec must be run in ISPF. It asks users if they know the */
/* PF keys, and when the answer is a variation of "no", it displays*/
/* the panel with the PF key definitions. */
/*******/
SAY 'Do you know your PF keys?'

PULL answer .
IF answer = 'NO' | answer = 'N' THEN
    ADDRESS ispexec "display PANEL(ispopt3c)"
ELSE
    SAY 'O.K. Never mind.'
```

ADDRESS Example 2

```
/****** REXX ******/
/* This exec must be run in ISPF. It blanks out previous data set */
/* name information from the fields of an ISPF panel named newtool.*/
/* It then displays the panel to the user. */
/*******/
ADDRESS ispexec
CALL blankem /* Call an internal subroutine */

IF RC = 0 THEN
    "display PANEL(newtool)"
ELSE
    "setmsg MSG(nt001)" /* Send an error message. */

EXIT

blankem:
'vget (ZUSER)'
ntgroup = '
nttype = '
ntmem = '
RETURN RC
```

ADDRESS Example 3

```

/***** REXX *****/
/* This exec must be run in ISPF. It displays panel named newtool */
/* and gets the name of a data set from input fields named ntproj, */
/* ntgroup, nttype, and ntmem. If no member name is specified (the*/
/* data set is sequential) the data set name does not include it. */
/* If a member name is specified, the member is added to data set */
/* name. The fully-qualified data set name is then inserted into a */
/* TRANSMIT command that includes single quotation marks and the */
/* destination, which was received from an input field named ntdest*/
/*****/
ADDRESS ispexec
"DISPLAY PANEL(newtool)"

ADDRESS tso /* re-establish the TSO host command environment */
IF ntmem = '' THEN /* member name is blank */
DO
    dsname = ntproj.'ntgroup'.nttype
    "TRANSMIT" ntdest "DA('dsname')"
END
ELSE
DO
    dsname = ntproj.'ntgroup'.nttype('ntmem')
    "TRANSMIT" ntdest "DA('dsname')"
END
END

```

ADDRESS Example 4

To link to or attach a logoff routine named MYLOGOFF and pass it the level of TSO/E installed, you can issue the following instructions from an exec.

```
ADDRESS LINK 'MYLOGOFF' SYSVAR(SYSTSOE)
```

or

```
ADDRESS ATTACH 'MYLOGOFF' SYSVAR(SYSTSOE)
```

Issuing Other Types of Commands from an Exec

Chapter 9. Diagnosing Problems Within an Exec

Debugging Execs	111
Tracing Commands with the TRACE Instruction	111
TRACE C	111
TRACE E	112
Using REXX Special Variables RC and SIGL	112
RC	112
SIGL	113
Tracing with the Interactive Debug Facility	113
Starting Interactive Tracing	114
Options Within Interactive Trace	116
Ending Interactive Trace	116

This chapter describes how to trace command output and other debugging techniques.

Debugging Execs

When you encounter an error in an exec, there are several ways to locate the error.

- The TRACE instruction displays how the language processor evaluates each operation. For information about using the TRACE instruction to evaluate expressions, see “Tracing Expressions with the TRACE Instruction” on page 37. For information about using the TRACE instruction to evaluate host commands, see the next section, “Tracing Commands with the TRACE Instruction”.
- Special variables, RC and SIGL, are set by the system to indicate:
 - The return code from a command - (RC)
 - The line number from which there was a transfer of control because of a function call, a SIGNAL instruction, or a CALL instruction - (SIGL)
- The TSO/E command EXECUTIL TS (Trace Start) and EXECUTIL TE (Trace End) control the interactive debug facility as do various options of the TRACE instruction. For more information about interactive debug, see “Tracing with the Interactive Debug Facility” on page 113.

Tracing Commands with the TRACE Instruction

The TRACE instruction has many options for various types of tracing, two of which are "commands" or "c" and "error" or "e".

TRACE C

When you specify "trace c" in an exec, any command that follows is traced before it is executed, then it is executed, and the return code from the command is displayed.

When an exec without "trace c" issues an incorrect TSO/E command, the exec ends with a TSO/E error message. For example, a LISTDS command specifies an incorrect data set name.

```
"LISTDS ?"
```

This example results in the following error message.

Debugging Execs

```
MISSING DATA SET NAME
INVALID KEYWORD, ?
***
```

If an exec includes "trace c" and again incorrectly issues the LISTDS command, the exec displays the line number and the command, executes it, and displays the error message and the return code from the command, as follows:

```
3 *- * "LISTDS ?"
>>> "LISTDS ?"
MISSING DATA SET NAME
INVALID KEYWORD, ?
+++ RC(12) +++
***
```

TRACE E

When you specify "trace e" in an exec, any host command that results in a nonzero return code is traced after it executes and the return code from the command is displayed.

If an exec includes "trace e" and again issues the previous incorrect LISTDS command, the exec displays error messages, the line number and the command, and the return code from the command, as follows:

```
MISSING DATA SET NAME
INVALID KEYWORD, ?
3 *- * "LISTDS ?"
+++ RC(12) +++
***
```

For more information about the TRACE instruction, see *z/OS TSO/E REXX Reference*.

Using REXX Special Variables RC and SIGL

As mentioned earlier, the REXX language has three special variables — RC, SIGL, and RESULT. These variables are set by the system during particular situations and can be used in an expression at any time. If the system did not set a value, a special variable displays its name, as do other variables in REXX. You can use two of these special variables, RC and SIGL, to help diagnose problems within execs.

RC

RC stands for return code and is set every time a command is issued. When a command ends without error, RC is usually set to 0. When a command ends in error, RC is set to whatever return code is assigned to that error.

For example, the previous incorrect LISTDS command is issued followed by the RC special variable in a SAY instruction.

```
"LISTDS ?"
SAY 'The return code from the command is' RC
```

This results in the following:

```
MISSING DATA SET NAME
INVALID KEYWORD, ?
The return code from the command is 12
***
```

The RC variable can be especially useful in an IF instruction to determine which path an exec should take.

```
'ALLOC DA('dsname') F(SYSPROC) SHR REUSE'
IF RC \= 0 THEN
  CALL error1
ELSE NOP
```

Note: The value of RC is set by every command and might not remain the same for the duration of an exec. When using RC, make sure it contains the return code of the command you want to test.

SIGL

The SIGL special variable is used in connection with a transfer of control within an exec because of a function, or a SIGNAL or CALL instruction. When the language processor transfers control to another routine or another part of the exec, it sets the SIGL special variable to the line number from which the transfer occurred.

```
000001 /* REXX */
  ⋮

000005 CALL routine
  ⋮

000008
000009 routine:
000010 SAY 'We came here from line' SIGL /* SIGL is set to 3 */
000011 RETURN
```

If the called routine itself calls another routine, SIGL is reset to the line number from which the most recent transfer occurred.

SIGL and the SIGNAL ON ERROR instruction can help determine what command caused an error and what the error was. When SIGNAL ON ERROR is included in an exec, any host command that returns a nonzero return code causes a transfer of control to a routine named "error". The error routine runs regardless of other actions that would normally take place, such as the display of error messages.

```
000001 /* REXX */
000002 SIGNAL ON ERROR
000003 "ALLOC DA(new.data) LIKE(old.data)"
  ⋮

000008 "LISTDS ?"
  ⋮

000011 EXIT
000012
000013 ERROR:
000014 SAY 'The return code from the command on line' SIGL 'is' RC
000015 /* Displays:
000016     The return code from the command on line 5 is 12 */
```

For more information about the SIGNAL instruction, see *z/OS TSO/E REXX Reference*.

Tracing with the Interactive Debug Facility

The interactive debug facility permits a user to interactively control the execution of an exec. A user can view the tracing of various types of instructions separated by pauses as the exec runs. During a pause, a user can continue to the next traced instruction, insert instructions, re-execute the previous instruction, and change or terminate interactive tracing.

Debugging Execs

Starting Interactive Tracing

You can start interactive tracing with either the ? option of the TRACE instruction or with the TSO/E EXECUTIL TS command. When interactive tracing is initiated with the TRACE instruction, interactive tracing is not carried over into external routines that are called but is resumed when the routines return to the traced exec. When interactive trace is initiated by the EXECUTIL TS command, interactive trace continues in all external routines called unless a routine specifically ends tracing.

? Option of the TRACE Instruction: One way to start interactive tracing is to include in an exec the TRACE instruction followed by a question mark and a trace option. For example, TRACE ?I (TRACE ?Intermediates). The question mark must precede the option with no blanks in between. Interactive tracing then begins for the exec but not for external routines the exec calls.

The following example includes a TRACE ?R (TRACE ?Results) instruction to interactively trace the result of each instruction.

Example of Interactive Trace

```
/****** REXX ******/
/* This exec receives as arguments the destination and the name */
/* of a data set. It then interactively traces the transmitting */
/* that data set to the destination and the returning of a message */
/* that indicates whether the transmit was successful.          */
/*******/
TRACE ?R
ARG dest dsname .
"TRANSMIT" dest "DA("dsname)"
IF RC = 0 THEN
  SAY 'Transmit successful.'
ELSE
  SAY 'Return code from transmit was' RC
```

If the arguments passed to this exec were "node1.mel" and a sequential data set named "new.exec", the interactively traced results would be as follows with each segment separated by a pause.

```
8 ** ARG dest dsname .
  >>> "NODE1.MEL"
  >>> "NEW.EXEC"
  >>> ""
+++ Interactive trace. TRACE OFF to end debug, ENTER to continue. +++
```

```
9 ** "TRANSMIT" dest "DA("dsname)"
  >>> "TRANSMIT NODE1.MEL DA(NEW.EXEC)"
0 message and 20 data records sent as 24 records to NODE1.MEL
Transmission occurred on 05/20/1989 at 14:40:11.
```

```
10 ** IF RC = 0
  >>> "1"
```

```
** THEN
11 ** SAY 'Transmit successful.'
  >>> "Transmit successful."
Transmit successful.
```

EXECUTIL TS Command: Another way to start interactive tracing is to issue the EXECUTIL TS (trace start) command or cause an attention interrupt and type TS. The type of interactive tracing begun is equivalent to that of the TRACE ?R instruction, except that tracing continues through all routines invoked unless it is specifically ended. For information about ending interactive trace, see “Ending Interactive Trace” on page 116.

The EXECUTIL TS command can be issued from several environments; it affects only the current exec and the execs it invokes. Like other TSO/E commands, EXECUTIL TS can be issued from within an exec, from READY mode, and from an ISPF panel.

- From Within an Exec

You can issue the EXECUTIL TS command from within an exec.

```

:
"EXECUTIL TS"
:
EXIT
  
```

The exec is then interactively traced from the point in the exec at which the command was issued. Any other execs that the exec invokes are also interactively traced.

You can also issue EXECUTIL TS from within a CLIST to initiate tracing in execs that the CLIST invokes.

- From READY Mode

You can issue the command from READY mode.

```

READY
executil ts
  
```

The next exec invoked from READY mode is then interactively traced. If that exec invokes another exec, the invoked exec is also interactively traced.

- From an ISPF Panel

You can also issue EXECUTIL TS from the ISPF COMMAND option or from the command line of an ISPF panel.

```

----- TSO COMMAND PROCESSOR -----
ENTER TSO COMMAND OR CLIST BELOW:

====> executil ts
  
```

```

----- ALLOCATE NEW DATA SET -----
COMMAND ====> tso executil ts
  
```

The next exec invoked from ISPF is then interactively traced. If that exec calls another exec, the called exec is also interactively traced. If you are in split screen mode in ISPF, an exec run from the opposite screen is not interactively traced because each side of a split screen is a different environment.

To begin interactive trace after pressing the attention interrupt key, sometimes labeled PA1, enter TS (trace start) after the message that the attention facility displays.

Debugging Execs

ENTER HI TO END, A NULL LINE TO CONTINUE, OR AN IMMEDIATE COMMAND+
ts

The type of tracing is the same as that initiated by issuing the EXECUTIL TS command.

Options Within Interactive Trace

When you are operating in the interactive debug facility, you have several options during the pauses that occur between each traced instruction. You can:

- Continue tracing by entering a null line
- Type one or more additional instructions to be processed before the next instruction is traced
- Enter an equal sign (=) to re-execute the last instruction traced
- End interactive tracing as described in the next topic.

Continuing Interactive Tracing: To continue tracing through an exec, simply press the Enter key to enter a null line during the pause between each traced instruction. The next traced instruction then appears on the screen. Repeatedly pressing the Enter key, therefore, takes you from pause point to pause point until the exec ends.

Typing Additional Instructions to be Processed: During the pause between traced instructions, you can enter one or more instructions that are processed immediately. The instruction can be any type of REXX instruction including a command or invocation to another exec or CLIST. You can also enter a TRACE instruction, which alters the type of tracing. After you enter the instruction, you might need to press the Enter key again to resume tracing.

```
TRACE L /* Makes the language processor pause at labels only */
```

The instruction can also change the course of an exec, such as by assigning a different value to a variable to force the execution of a particular branch in an IF THEN ELSE instruction. In the following example, RC is set by a previous command.

```
IF RC = 0 THEN
  DO
    instruction1
    instruction2
  END
ELSE
  instructionA
```

If during normal execution, the command ends with other than a 0 return code, the ELSE path will be taken. To force taking the IF THEN path during interactive trace, you can change the value of RC as follows during a pause.

```
RC = 0
```

Re-executing the Last Instruction Traced: You can re-execute the last instruction traced by entering an equal sign (=) with no blanks. The language processor then re-executes the previously traced instruction with values possibly modified by instructions, if any were entered during the pause.

Ending Interactive Trace

You can end interactive tracing in one of the following ways:

- Use the TRACE OFF instruction.

- Let the exec run until it ends.
- Use the TRACE ? instruction.
- Issue the EXECUTIL TE command.

TRACE OFF: The TRACE OFF instruction ends tracing as stated in the message displayed at the beginning of interactive trace.

+++ Interactive trace. TRACE OFF to end debug, ENTER to continue. +++

You can enter the TRACE OFF instruction only during a pause while interactively tracing an exec.

End the Exec: Interactive tracing automatically ends when the exec that initiated tracing ends. You can cause the exec to end prematurely by entering the EXIT instruction during a pause. The EXIT instruction causes the exec and interactive tracing both to end.

TRACE ?: The question mark prefix before a TRACE option can end interactive tracing as well as begin it. The question mark reverses the previous setting for interactive tracing.

While interactively tracing an exec, you can also enter the TRACE ? instruction with any operand to discontinue the interactive debug facility but continue the type of tracing specified by the operand.

EXECUTIL TE: The EXECUTIL TE (Trace End) command ends interactive tracing when issued from within an exec or when entered during a pause while interactively tracing an exec.

For more information about the EXECUTIL command, see *z/OS TSO/E REXX Reference*.

Debugging Execs

Chapter 10. Using TSO/E External Functions

TSO/E External Functions	119
Using the GETMSG Function	120
Using the LISTDSI Function	120
Using the MSG Function	122
Using the MVSVAR Function	123
Using the OUTTRAP Function	123
Using the PROMPT Function	124
Using the SETLANG Function	125
Using the STORAGE Function	126
Using the SYSCPUS Function	126
Using the SYSDSN Function	126
Using the SYSVAR Function	127
User Information	128
Terminal Information	128
Language Information	128
Exec Information	128
System Information	128
Console Session Information	129
Additional Examples	130
Function Packages	133
Search Order for Functions	134

This chapter shows how to use TSO/E external functions and describes function packages.

TSO/E External Functions

In addition to the built-in functions, TSO/E provides external functions that you can use to do specific tasks. Some of these functions perform the same services as control variables in the CLIST language.

The TSO/E external functions are:

- GETMSG - returns in variables a system message issued during an extended MCS console session. It also returns in variables associated information about the message. The function call is replaced by a function code that indicates whether the call was successful.
- LISTDSI - returns in variables the data set attributes of a specified data set. The function call is replaced by a function code that indicates whether the call was successful.
- MSG - controls the display of TSO/E messages. The function returns the previous setting of MSG.
- MVSVAR - uses specific argument values to return information about MVS, TSO/E, and the current session.
- OUTTRAP - traps lines of TSO/E command output into a specified series of variables. The function call returns the variable name specified.
- PROMPT - sets the prompt option on or off for TSO/E interactive commands. The function returns the previous setting of prompt.
- SETLANG - retrieves and optionally changes the language in which REXX messages are displayed. The function returns the previous language setting.
- STORAGE - retrieves and optionally changes the value in a storage address.

TSO/E External Functions

- SYSCPUS - returns in a stem variable information about all CPUs that are on-line.
- SYSDSN - returns OK if the specified data set exists; otherwise, it returns an appropriate error message.
- SYSVAR - uses specific argument values to return information about the user, terminal, language, exec, system, and console session.

Following are brief explanations about how to use the TSO/E external functions. For complete information, see *z/OS TSO/E REXX Reference*.

Using the GETMSG Function

The GETMSG function retrieves a system message issued during an extended MCS console session. The retrieved message can be either a response to a command or any other system message, depending on the message type you specify.

The message text and associated information are stored in variables, which can be displayed or used within the REXX exec. The function call is replaced by a function code that indicates whether the call was successful. See *z/OS TSO/E REXX Reference* for more information about the syntax, function codes, and variables for GETMSG. You must have CONSOLE command authority to use the GETMSG function. Before you issue GETMSG, you must:

- Use the TSO/E CONSPROF command to specify the types of messages that are not to be displayed at the terminal. The CONSPROF command can be used before you activate a console session and during a console session if values need to be changed.
- Use the TSO/E CONSOLE command to activate an extended MCS console session.

The GETMSG function can be used only in REXX execs that run in the TSO/E address space.

Using the LISTDSI Function

You can use the LISTDSI (list data set information) function to retrieve detailed information about a data set's attributes. The attribute information is stored in variables, which can be displayed or used within instructions. The function call is replaced by a function code that indicates whether the call was successful.

The LISTDSI function can be used only in REXX execs that run in the TSO/E address space.

To retrieve the attribute information, include the data set name within parentheses after LISTDSI. When you specify a fully-qualified data set name, be sure to enclose it in two sets of quotation marks as follows; one set to define it as a literal string to REXX and the other to indicate a fully-qualified data set to TSO/E.

```
x = LISTDSI("'proj5.rexx.exec'") /* x is set to a function code */
```

or

```
x = LISTDSI('proj5.rexx.exec') /* x is set to a function code */
```

When you specify a data set name that begins with your prefix (usually your user ID), you can use one set of quotation marks to define it as a literal string or no quotation marks. TSO/E adds your prefix to the data set name whether or not it is enclosed within a set of quotation marks.

```
x = LISTDSI('my.data')           /* x is set to a function code */
x = LISTDSI(my.data)             /* x is set to a function code */
```

When you specify a variable that was previously set to a data set name, do *not* enclose the variable in quotation marks. Quotation marks would prevent the data set name from being substituted for the variable name.

```
variable = 'my.data'
x = LISTDSI(variable)
```

You cannot use LISTDSI with the *filename* parameter if the filename is allocated to a data set

- which exists more than once with the same name on different volumes, and
- which is already in use

because in this case the system may not retrieve information for the data set you wanted. After LISTDSI executes, the function call is replaced by one of the following function codes:

Function Code	Meaning
0	Normal completion
4	Some data set information is unavailable. All data set information other than directory information can be considered valid.
16	Severe error occurred. None of the variables containing information about the data set can be considered valid.

The following variables are set to the attributes of the data set specified.

Variable	Contents
SYSDSNAME	Data set name
SYSVOLUME	Volume serial ID
SYSUNIT	Device unit on which volume resides
SYSDSORG	Data set organization: PS, PSU, DA, DAU, IS, ISU, PO, POU, VS
SYSRECFM	Record format; three-character combination of the following: U, F, V, T, B, S, A, M
SYSLRECL	Logical record length
SYSBLKSIZE	Block size
SYSKEYLEN	Key length
SYSALLOC	Allocation, in space units
SYSUSED	Allocation used, in space units
SYSUSEDPAGES	Used space of a partitioned data set extended (PDSE) in 4K pages.
SYSPRIMARY	Primary allocation in space units
SYSSECONDS	Secondary allocation in space units
SYSUNITS	Space units: CYLINDER, TRACK, BLOCK
SYSEXTENTS	Number of extents allocated
SYSCREATE	Creation date: Year/day format, for example: 1985/102

TSO/E External Functions

Variable	Contents
SYSREFDATE	Last referenced date: Year/day format, for example: 1985/107 (Specifying DIRECTORY causes the date to be updated.)
SYSEXDATE	Expiration date: Year/day format, for example: 1985/365
SYSPASSWORD	Password indication: NONE, READ, WRITE
SYSRACFA	RACF indication: NONE, GENERIC, DISCRETE
SYSUPDATED	Change indicator: YES, NO
SYSTRKSCYL	Tracks per cylinder for the unit identified in the SYSUNIT variable
SYSBLKSTRK	Blocks per track for the unit identified in the SYSUNIT variable
SYSADIRBLK	Directory blocks allocated - returned only for partitioned data sets when DIRECTORY is specified
SYSUDIRBLK	Directory blocks used - returned only for partitioned data sets when DIRECTORY is specified
SYSMEMBERS	Number of members - returned only for partitioned data sets when DIRECTORY is specified
SYSREASON	LISTDSI reason code
SYSMSGVL1	First-level message if an error occurred
SYSMSGVL2	Second-level message if an error occurred
SYSDSSMS	Information about the type of a data set provided by DFSMS/MVS.
SYSDATACLASS	SMS data class name
SYSSTORCLASS	SMS storage class name
SYSMGMTCLASS	SMS management class name

Using the MSG Function

The MSG function can control the display of TSO/E messages. When the MSG function is not used, both error and non-error messages are displayed as an exec runs. These messages can interfere with output, especially when the exec's output is a user interface, such as a panel.

The MSG function can be used only in REXX execs that run in the TSO/E address space.

To prevent the display of TSO/E messages as an exec runs, use the MSG function followed by the word "OFF" enclosed within parentheses.

```
status = MSG('OFF')    /* status is set to the previous setting of */  
                      /* MSG and sets the current setting to OFF */
```

To resume the display of TSO/E messages, substitute the word "ON" for "OFF".

To find out if messages will be displayed, issue the MSG function followed by empty parentheses.

```
status = MSG()         /* status is set to ON or OFF */
```

Using the MVSVAR Function

The MVSVAR function retrieves information about MVS, TSO/E, and the current session, such as the symbolic name of the MVS system, or the security label of the TSO/E session. The information retrieved depends on the argument specified.

To retrieve the information, use the MVSVAR function immediately followed by an argument value enclosed in parentheses. For example, to find out the APPC/MVS logical unit (LU) name, use the MVSVAR function with the argument SYSAPPCLU.

```
appclu = MVSVAR('SYSAPPCLU')
```

The MVSVAR function is available **in any MVS address space**. Compare this to the SYSVAR function which also retrieves system information but can only be used in REXX execs that run in the TSO/E address space.

Many of the MVSVAR arguments retrieve the same information as do CLIST control variables.

The following table lists the items of information that are available for retrieval by MVSVAR.

Argument Value	Description
SYSAPPCLU	the APPC/MVS logical unit (LU) name
SYSDFP	the level of MVS/Data Facility Product (MVS/DFP)
SYSMVS	the level of the base control program (BCP) component of z/OS
SYSNAME	the name of the system your REXX exec is running on, as specified in the SYSNAME statement in SYS1.PARMLIB member IEASYSxx
SYSSECLAB	the security label (SECLABEL) name of the TSO/E session
SYSSMFID	identification of the system on which System Management Facilities (SMF) is active
SYSSMS	indicator whether DFSMS/MVS is available to your REXX exec
SYSCLONE	MVS system symbol representing its system name
SYSPLEX	the MVS sysplex name as found in the COUPLExx or LOADxx member of SYS1.PARMLIB
SYMDEF	symbolic variables of your MVS system

Using the OUTTRAP Function

The OUTTRAP function puts lines of command output into a series of numbered variables, each with the same prefix. These variables save the command output and allow an exec to process the output. Specify the variable name in parentheses following the function call.

```
SAY 'The OUTTRAP variable name is' OUTTRAP('var')
/* Displays the variable name in which command output is trapped. */
```

In this example, the variable var becomes the prefix for the numbered series of variables. Var1, var2, var3, and so on, receive a line of output each. If you do not set a limit to the number of output lines, the numbering of variables continues as

TSO/E External Functions

long as there is output. Output from the most recent command is placed after the previous command's output. The total number of lines trapped is stored in var0.

```
x = OUTTRAP('var')
"LISTC"
SAY 'The number of lines trapped is' var0
```

To limit the number of lines of output saved, you can specify a limit, for example 5, after the variable name.

```
x = OUTTRAP('var',5)
```

This results in up to 5 lines of command output stored in var1, var2, var3, var4, var5; and var0 contains the number 5. Subsequent lines of command output are not saved.

The following example traps output from two commands and then displays the member names from a partitioned data set named MYNEW.EXEC. The stem variable includes a period, which causes the lines of output to be stored in a series of compound variables. For more information about compound variables, see "Using Compound Variables and Stems" on page 85.

```
x = OUTTRAP('var.')
"LISTC"
SAY 'The number of lines trapped is' var.0 /* could display 205 */
lines = var.0 + 1
"LISTDS mynew.exec MEMBERS"
SAY 'The number of lines trapped is' var.0 /* could display 210 */
DO i = lines TO var.0
  SAY var.i /* displays 5 members */
END
```

To turn trapping off, reissue the OUTTRAP function with the word "OFF".

```
x = OUTTRAP('OFF') /* turns trapping OFF */
```

The OUTTRAP function can be used only in REXX execs that run in the TSO/E address space.

The OUTTRAP function does not trap all lines of command output from all TSO/E commands. For more information, see *z/OS TSO/E REXX Reference*.

Using the PROMPT Function

When your profile allows for prompting, the PROMPT function can set the prompting option on or off for interactive TSO/E commands, or it can return the type of prompting previously set. When prompting is on, execs can issue TSO/E commands that prompt the user for missing operands.

The PROMPT function can be used only in REXX execs that run in the TSO/E address space.

To set the prompting option on, use the PROMPT function followed by the word "ON" enclosed within parentheses.

```
x = PROMPT('ON') /* x is set to the previous setting of prompt */
/* and sets the current setting to ON */
```

To set prompting off, substitute the word "OFF" for "ON".

To find out if prompting is available for TSO/E interactive commands, use the PROMPT function followed by empty parentheses.

```
x = PROMPT()          /* x is set to ON or OFF */
```

The PROMPT function overrides the NOPROMPT operand of the EXEC command, but it cannot override a NOPROMPT operand in your TSO/E profile. To display your profile, issue the PROFILE command. To change a profile from NOPROMPT to PROMPT, issue:

```
PROFILE PROMPT
```

Using the SETLANG Function

You can use the SETLANG function to determine the language in which REXX messages are currently being displayed and to optionally change the language. If you do not specify an argument, SETLANG returns a 3-character code that indicates the language in which REXX messages are currently being displayed. Table 1 shows the language codes that replace the function call and the corresponding language for each code.

You can optionally specify one of the language codes on the function call to change the language in which REXX messages are displayed. In this case, SETLANG sets the language to the code specified and returns the language code of the previous language setting. The language codes you can specify on SETLANG depend on the language features that are installed on your system.

Table 1. Language Codes for SETLANG Function That Replace the Function Call

Language Code	Language
CHS	Simplified Chinese
CHT	Traditional Chinese
DAN	Danish
DEU	German
ENP	US English-all uppercase
ENU	US English-mixed case (uppercase and lowercase)
ESP	Spanish
FRA	French
JPN	Japanese
KOR	Korean
PTB	Brazilian Portuguese

To find out the language in which REXX messages are currently being displayed, issue the SETLANG function followed by empty parentheses:

```
curlang=SETLANG()      /* curlang is set to the 3-character */
                       /* code of the current language setting. */
```

To set the language to Japanese for subsequent REXX message displays, issue the SETLANG function followed by the 3-character code, JPN, enclosed within parentheses:

```
oldlang=SETLANG(JPN)  /* oldlang is set to the previous */
                       /* language setting. */
                       /* The current setting is set to JPN. */
```

TSO/E External Functions

The SETLANG function can be used in REXX execs that run in any MVS address space.

Using the STORAGE Function

You can use the STORAGE function to retrieve data from a particular address in storage. You can also use the STORAGE function to place data into a particular address in storage.

The STORAGE function can be used in REXX execs that run in any MVS address space.

Using the SYSCPUS Function

The SYSCPUS function places, in a stem variable, information about those CPUs that are on-line.

The SYSCPUS function runs **in any MVS address space**.

Example:

Consider a system with two on-line CPUs. Their serial numbers are FF0000149221 and FF1000149221. Assuming you issue the following sequence of statements

```
/* REXX */
x = SYSCPUS('cpus.')
SAY '0, if function performed okay: ' x
SAY 'Number of on-line CPUs is ' cpus.0
DO i = 1 TO CPUS.0
  SAY 'CPU' i ' has CPU info ' cpus.i
END
```

you get the following output:

```
0, if function performed okay: 0
Number of on-line CPUs is 2
CPU 1 has CPU info FF0000149221
CPU 2 has CPU info FF1000149221
/* ↑      ↑      */
/* |      4 digits = model number */
/* 6 digits      = CPU ID      */
```

Using the SYSDSN Function

The SYSDSN function determines if a specified data set is available for your use. If the data set is available for your use, it returns "OK".

```
available = SYSDSN('myrexx.exec')
/* available could be set to "OK" */
```

When a data set is not correct as specified or when a data set is not available, the SYSDSN function returns one of the following messages:

- MEMBER SPECIFIED, BUT DATASET IS NOT PARTITIONED
- MEMBER NOT FOUND
- DATASET NOT FOUND
- ERROR PROCESSING REQUESTED DATASET
- PROTECTED DATASET
- VOLUME NOT ON SYSTEM
- UNAVAILABLE DATASET

- INVALID DATASET NAME, *data-set-name*:
- MISSING DATASET NAME

After a data set is available for use, you may find it useful to get more detailed information. For example, if you later need to invoke a service that requires a specific data set organization, then use the LISTDSI function. For a description of the LISTDSI function, see “Using the LISTDSI Function” on page 120.

When you specify a fully-qualified data set, be sure to use two sets of quotation marks as follows; one set to define a literal string to REXX and the other set to indicate a fully-qualified data set to TSO/E.

```
x = SYSDSN("'proj5.rexx.exec'")
```

or

```
x = SYSDSN('proj5.rexx.exec')
```

When you specify a data set that is not fully-qualified and begins with your prefix (usually your user ID), you can use one set of quotation marks or none at all. TSO/E adds your prefix to the data set name whether or not it is enclosed within a set of quotation marks.

```
x = SYSDSN('myrexx.exec')
```

or

```
x = SYSDSN(myrexx.exec)
```

When you specify a variable that was previously set to a data set name, do *not* enclose the variable in quotation marks. Quotation marks would prevent the data set name from being substituted for the variable name.

```
variable = 'myrexx.exec'
x = SYSDSN(variable)
```

The following example uses the SYSDSN function together with the LISTDSI function to test whether a data set exists and whether it is a partitioned data set:

```
DO FOREVER
  SAY 'Enter a Data Set Name'
  PARSE UPPER PULL dsname
  IF SYSDSN(dsname) ^= 'OK' THEN ITERATE
  FC = LISTDSI(dsname)
  IF SYSDSORG ^= 'PO' THEN ITERATE
  SAY 'Okay: ' dsname 'is ' SYSDSORG
  LEAVE
END
```

The SYSDSN function can be used only in REXX execs that run in the TSO/E address space.

Using the SYSVAR Function

The SYSVAR function retrieves information about MVS, TSO/E, and the current session, such as levels of software available, your logon procedure, and your user ID. The information retrieved depends on the argument specified.

To retrieve the information, use the SYSVAR function immediately followed by an argument value enclosed in parentheses. For example, to find out the name of the logon procedure of your current session, use the SYSVAR function with the argument SYSPROC.

TSO/E External Functions

proc = SYSVAR(sysproc)

The SYSVAR function can be used only in REXX execs that run in the TSO/E address space.

Many of the SYSVAR arguments retrieve the same information as do CLIST control variables. The following tables divide the argument values into categories pertaining to user, terminal, language, exec, system, and console session information.

User Information

Argument Value	Description
SYSPREF	Prefix as defined in user profile
SYSPROC	SYSPROC returns the current procedure name (either the LOGON procedure name, the Started Task procedure name, or 'INIT' for a batch job). For more information, see <i>z/OS TSO/E REXX Reference</i> .
SYSUID	User ID of current session

Terminal Information

Argument Value	Description
SYSLTERM	Number of lines available on screen
SYSWTERM	Width of screen

Language Information

Argument Value	Description
SYSPLANG	Primary language for translated messages
SYSSLANG	Secondary language for translated messages
SYSDTERM	Whether DBCS is supported for this terminal
SYSKTERM	Whether Katakana is supported for this terminal

Exec Information

Argument Value	Description
SYSENV	Whether exec is running in foreground or background
SYSICMD	Name by which exec was implicitly invoked
SYSISPF	Whether ISPF is available for exec
SYSNEST	Whether exec was invoked from another exec or CLIST. Invocation could be implicit or explicit.
SYSPCMD	Name of most recently executed command
SYSSCMD	Name of most recently executed subcommand

System Information

Argument Value	Description
SYSCPU	Number of CPU seconds used during session in the form: <i>seconds.hundredths of seconds</i>

TSO/E External Functions

Argument Value	Description
SYSHSM	Level of Data Facility Hierarchical Storage Manager (DFHSM) installed
SYSJES	Name and level of JES installed
SYSLRACF	Level of RACF installed
SYSRACF	Whether RACF is available
SYSNODE	Network node name of the installation's JES
SYSSRV	Number of system resource manager (SRM) service units used during session
SYSTEMID	Terminal ID of the terminal where the REXX exec was started
SYSTSOE	Level of TSO/E installed in the form: <i>version release modification_number</i>

Console Session Information

Argument Value	Description
SOLDISP	Whether solicited messages (command responses) should be displayed at terminal
UNSDISP	Whether unsolicited messages should be displayed at terminal
SOLNUM	The number of solicited messages (command responses) to be held in message table
UNSNM	The number of unsolicited messages to be held in message table
MFTIME	Whether time stamp should be displayed with messages
MFOSNM	Whether originating system name should be displayed with messages
MFJOB	Whether originating job name or job ID should be displayed with messages
MFSNMJBX	Whether system name and job name should be excluded from display of retrieved messages

Additional Examples

Example 1 - Using the LISTDSI and SYSDSN Functions

```

/***** REXX *****/
/* This exec reallocates a data set with more space. It receives */
/* as arguments the names of a base data set and a new data set. */
/* It uses the SYSDSN function to ensure the base data set exists, */
/* uses the LISTDSI function to set variables with attributes of */
/* the base data set, doubles the primary space variable and then */
/* uses the variables as input to the ALLOCATE command to */
/* reallocate a new data set. */
/*****/

PARSE ARG baseds newds          /* Receive the data set names */
                                /* with quotes, if any. */

IF SYSDSN(baseds) = 'OK' THEN
  DO                               /* If the base data set exists, */
    x = LISTDSI(baseds)          /* use the LISTDSI function. */
    IF x = 0 THEN                /* If the function code is 0, */
      CALL alc                  /* call an internal subroutine.*/
    ELSE
      DO                               /* Else, display the system */
        SAY sysmsglv11          /* messages and codes for LISTDS*/
        SAY sysmsglv12
        SAY 'Function code from LISTDSI is' x
        SAY 'Sysreason code from LISTDSI is' sysreason
      END
    END
  ELSE
    SAY 'Data set' baseds 'not found.'
  EXIT

alc:
newprimary = 2 * sysprimary      /* Compute new primary space. */
"ALLOC DA("newds") NEW SPACE("newprimary sysseconds") LIKE("baseds)"
                                /* Allocate the new data set. */
IF RC = 0 THEN                  /* If return code from allocate is 0 */
  SAY 'Data set' newds 'was allocated.'
ELSE
  SAY 'Data set' newds 'was not allocated. Return code was' RC

```

Example 2 Part 1 - Using the OUTTRAP Function

```

/***** REXX *****/
/* This exec adds a data set to the front of the data sets in the */
/* SYSPROC concatenation. It first asks for the name of the data */
/* set to add, then it finds all data sets currently allocated to */
/* SYSPROC, adds the new data set to the beginning and re-allocates*/
/* the concatenation to SYSPROC. */
/*****/
SAY 'Enter the fully-qualified data set name you want added'
SAY 'to the beginning of the SYSPROC concatenation. Do NOT'
SAY 'place quotation marks around the data set name.'

PULL addname .

x = OUTTRAP('name.')
```

/*Begin trapping lines of output from commands*/
/* Output goes to variables beginning with 'name.'*/

```

"LISTA ST" /* List the status of your currently allocations */
found = 'NO' /* Set the found flag to no */
i = 1 /* Set the index variable to 1 */

/*****/
/* Loop through the lines of trapped command output to find lines */
/* 9 characters long or longer. Check those lines for the word */
/* SYSPROC until it is found or until all lines have been checked. */
/* If SYSPROC is found, the index is decreased one and the name of */
/* the first data set concatenated to SYSPROC is stored in variable*/
/* "concat". */
/*****/
DO WHILE (found = 'NO') & (i <= name.0)
  IF LENGTH(name.i) >= 9 THEN
    IF SUBSTR(name.i,3,7) = 'SYSPROC' THEN
      DO
        found = 'YES'
        i = i - 1
        concat = ""name.i""
      END
    ELSE
      i = i + 1
  ELSE
    i = i + 1
END
END

```

Additional Examples

Example 2 Part 2 - Using the OUTTRAP Function

```
/******  
/* When SYSPROC is found, loop through data sets until another file*/  
/* name is encountered or until all lines are processed. Append */  
/* data set names to the one in variable "concat". */  
/******  
IF found = 'YES' THEN  
  DO WHILE (i + 3) <= name.0  
    i = i + 3  
    IF SUBSTR(name.i,1,3) = ' ' THEN  
      DO  
        i = i - 1  
        concat = concat,""name.i""  
      END  
    ELSE  
      i = name.0  
    END  
  END  
ELSE NOP  
  
/* Allocate the new concatenation to SYSPROC */  
"ALLOC F(sysproc) DA(""addname"", "concat") SHR REUSE"
```

Example 3 - Using the OUTTRAP Function

```

/***** REXX *****/
/* This exec lists datasets allocated to a ddname that is passed */
/* as an argument when the exec is invoked. It uses the OUTTRAP */
/* function to trap output from the LISTA STATUS command. It then */
/* loops through the output looking for a match to the input ddname*/
/* When match is found, the exec will SAY the name of all datasets */
/* allocated to that ddname. */
/* */
/* The LISTA STATUS command produces output of the form */
/* */
/*     DATASET-NAME-ALLOCATED-TO-DDNAME */
/*     DDNAME DISP */
/* */
/* In this output when the area for DDNAME is blank, then the data */
/* set is allocated to the previous DDNAME that was not blank. This*/
/* condition is one of the tests in the program below. */
/* */
/*****/

ARG ddname .

x = OUTTRAP('ddlist.') /* start output trapping into DDLIST*/
"LISTA STATUS" /* issue the LISTA command */
x = OUTTRAP('OFF') /* turn off output trapping */

done = 'NO' /* initialize loop control variable */

DO i = 1 TO ddlist.0 WHILE done = 'NO'

  IF (words(ddlist.i) = 2) & ddname = word(ddlist.i,1) THEN
    DO /* if there is a DDNAME & it matches*/
      firstdataset = i - 1 /* back up to first dataset name */
      SAY ddlist.firstdataset /* Give the first dataset allocated */
      DO j = i+1 TO ddlist.0 BY 2 WHILE done = 'NO'
        next = j + 1
        IF (next <= ddlist.0) & (words(ddlist.next)\=1) THEN
          done = 'YES' /* if we reach the end of the command
                        output, or the next DDNAME, we are
                        done */
        ELSE
          SAY ddlist.j /* Give the next dataset allocated */
        END
      END
    END

  If done = 'NO' then /* If the DDNAME is not allocated */
    say "The DDNAME" ddname "is not allocated."
    /* Then say so */

EXIT 0

```

Function Packages

A **function package** is a group of external routines (functions and subroutines) that are accessed more quickly than external routines written in interpreted REXX. Routines in a function package must be written in a programming language that produces object code, which can be link-edited into a load module. The routine must also support the system interface for function packages. Some programming languages that meet these qualifications are assembler, COBOL, and PL/I.

There are three types of function packages.

Function Packages

- User packages — User-written external functions that are available to an individual. These functions are searched before other types of function packages and are often written to replace the other types of function packages.
- Local packages — Application or system support functions that are generally available to a specific group of users. Local packages are searched after user packages.
- System packages — Functions written for system-wide use, such as the TSO/E external functions. System packages are searched after user and local packages.

Function packages written by a user or an installation must be pre-loaded at logon time. The default name for the user packages is IRXFUSER, and the default name for the local package is IRXFLOC. Other function packages can be named in a parameter block set up by a system programmer.

For more information about function packages, see *z/OS TSO/E REXX Reference*.

Search Order for Functions

When the language processor encounters a function call, if defaults have not been changed, it goes through the following search order:

- Internal functions — Labels in the exec that issued the function call are searched first (unless the label is in quotation marks in the function call).
- Built-in functions — The built-in functions are next in the search order.
- Function packages — User, local, and system function packages, in that order, are searched.
- Load libraries — Functions stored in a load library are next in the search order.
- External function — An external function and its caller must either be members in the same PDS or members of PDSs allocated to a system library, such as SYSEXEC or SYSPROC.

Chapter 11. Storing Information in the Data Stack

What is a Data Stack?	135
Manipulating the Data Stack	136
Adding Elements to the Data Stack	136
Removing Elements from the Stack	137
Determining the Number of Elements on the Stack	137
Exercise - Using the Data Stack	138
Processing of the Data Stack	139
Using the Data Stack	140
Passing Information Between a Routine and the Main Exec	140
Passing Information to Interactive Commands	142
Issuing Subcommands of TSO/E Commands	142
Creating a Buffer on the Data Stack.	142
Creating a Buffer with the MAKEBUF Command	143
Removing Elements from a Stack with a Buffer	143
Dropping a Buffer with the DROPBUF Command	144
Finding the Number of Buffers with the QBUF Command	144
Finding the Number of Elements In a Buffer.	145
Exercises - Creating a Buffer on the Data Stack	145
Protecting Elements in the Data Stack	147
Creating a New Data Stack with the NEWSTACK Command	148
Deleting a Private Stack with the DELSTACK Command	149
Finding the Number of Stacks	149
Additional Examples	150

This chapter describes how to use the REXX data stack to store information. Also, this chapter describes how to add a buffer to a data stack and how to create a private data stack in TSO/E.

What is a Data Stack?

REXX in TSO/E uses an expandable data structure called a *data stack* to store information. The data stack combines characteristics of a conventional stack and queue.

Stacks and queues are similar types of data structures used to temporarily hold data items (elements) until needed. When elements are needed, they are removed from the top of the data structure. The basic difference between a stack and a queue is where elements are added (as shown in the following figure). Elements are added to the top of a stack and to the bottom of a queue.

Using a *stack*, the last element added to the stack (elem6) is the first removed. Because elements are placed on the top of a stack and removed from the top, the newest elements on a stack are the ones processed first. The technique is called LIFO (last in first out).

Using a *queue*, the first element added to the queue (elem1) is the first removed. Because elements are placed on the bottom of a queue and removed from the top, the oldest elements on a queue are the ones processed first. The technique is called FIFO (first in first out).

What is a Data Stack?

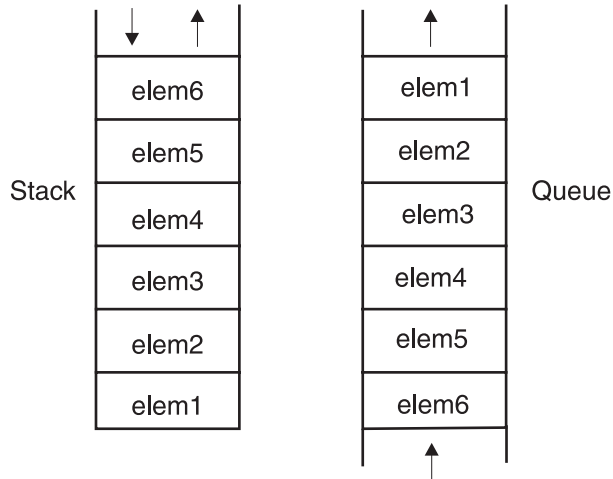

As shown in the following figure, the data stack that REXX uses combines the techniques used in adding elements to stacks and queues. Elements can be placed on the top or the bottom of a data stack. Removal of elements from the data stack, however, occurs from the top of the stack only.

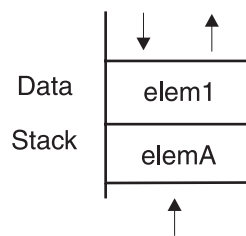

Manipulating the Data Stack

There are several REXX instructions that manipulate the data stack. Two instructions add elements to the data stack and another removes elements from the data stack.

Adding Elements to the Data Stack

You can store information on the data stack with two instructions, PUSH and QUEUE.

PUSH - puts one item of data on the top of the data stack. There is virtually no limit to the length of the data item.

```
elem1 = 'String 1 for the data stack'  
PUSH elem1
```

QUEUE - puts one item of data on the bottom of the data stack. Again, there is virtually no limit to the length of the data item.

```
elemA = 'String A for the data stack'  
QUEUE elemA
```

If the two preceding sets of instructions were in an exec, the data stack would appear as follows:

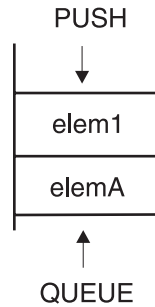

Note: Some people find it less confusing when adding elements in a particular order to the data stack, to consistently use the same instruction, either PUSH or QUEUE, but not both.

Removing Elements from the Stack

To remove information from the data stack, use the PULL and PARSE PULL instructions, the same instructions used previously in this book to extract information from the terminal. (When the data stack is empty, PULL removes information from the terminal.)

PULL and PARSE PULL - remove one element from the top of the data stack.

```
PULL stackitem
```

Using the examples from “Adding Elements to the Data Stack” on page 136, the variable `stackitem` then contains the value of `elem1` with the characters translated to uppercase.

```
SAY stackitem          /* displays STRING 1 FOR THE DATA STACK */
```

When you add PARSE to the preceding instruction, the value is not translated to uppercase.

```
PARSE PULL stackitem
SAY stackitem          /* displays String 1 for the data stack */
```

After either of the preceding examples, the data stack appears as follows:

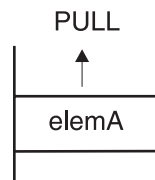

Determining the Number of Elements on the Stack

The QUEUED built-in function returns the total number of elements on a data stack. For example, to find out how many elements are on the data stack, you can use the QUEUED function with no arguments.

```
SAY QUEUED()          /* displays a decimal number */
```

To remove all elements from a data stack and display them, you can use the QUEUED function as follows:

Manipulating the Data Stack

```
number = QUEUED()
DO number
  PULL element
  SAY element
END
```

Exercise - Using the Data Stack

Write an exec that puts the letters T, S, O, E on the data stack in such a way that they spell "TSOE" when removed. Use the QUEUED built-in function and the PULL and SAY instructions to help remove the letters and display them. To put the letters on the stack, you can use the REXX instructions PUSH, QUEUE, or a combination of the two.

ANSWER

Possible Solution 1

```
/****** REXX *****/
/* This exec uses the PUSH instruction to put the letters T,S,O,E,*/
/* on the data stack in reverse order. */
/*******/

PUSH 'E'
PUSH 'O'
PUSH 'S'
PUSH 'T'

number = QUEUED()
DO number
  PULL stackitem
  SAY stackitem
END

/*******/
/* Data in stack is: */
/* (fourth push) T */
/* (third push) S */
/* (second push) O */
/* (first push) E */
/*******/
```

Possible Solution 2

```
/****** REXX *****/
/* This exec uses the QUEUE instruction to put the letters T,S,O,E,*/
/* on the data stack in that order. */
/*******/

QUEUE 'T'
QUEUE 'S'
QUEUE 'O'
QUEUE 'E'

DO QUEUED()
  PULL stackitem
  SAY stackitem
END

/*******/
/* Data in stack is: */
/* (first queue) T */
/* (second queue) S */
/* (third queue) O */
/* (fourth queue) E */
/*******/
```

Possible Solution 3

```

/***** REXX *****/
/* This exec uses the PUSH and QUEUE instructions to put T,S,O,E */
/* on the data stack. */
/*****/

PUSH 'S'                               /* Data in stack is: */
QUEUE 'O'                               /* (second push) T */
PUSH 'T'                               /* (first push) S */
QUEUE 'E'                               /* (first queue) O */

DO QUEUED()                             /* (second queue) E */
  PULL stackitem
  SAY stackitem
END

```

Processing of the Data Stack

You can think of a data stack as a temporary holding place for information. Every TSO/E REXX user has a separate data stack available for each REXX environment that is initialized. REXX environments are initialized at the READY prompt, when you enter ISPF, and again when you split the screen in ISPF.

When an exec issues a PULL instruction, and when it issues an interactive TSO/E command, the data stack is searched first for information and if that is empty, information is retrieved from the terminal.

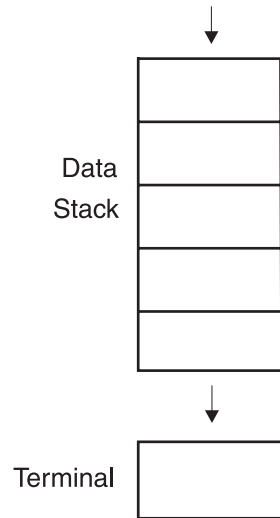

Some types of input that can be stored on the data stack are:

- Data for the PULL and PARSE PULL instructions

When an exec issues a PULL instruction, the language processor first goes to the data stack and pulls off the top element. If the data stack is empty, the language processor goes to the terminal for input. When the data stack is empty, the PULL instruction can be used with the SAY instruction to interact with a user at the terminal.

Processing of the Data Stack

Note: To prevent the language processor from searching the data stack, you can issue the PARSE EXTERNAL instruction instead of PULL. PARSE EXTERNAL gets input directly from the terminal and bypasses the data stack.

- Responses to commands

A TSO/E interactive command (such as LISTDS, TRANSMIT, and ALLOCATE) can prompt a terminal user for information. Similarly, user responses can be put on the data stack by an exec for the command's use.

- Commands to be issued after the exec ends

When an exec ends, all elements remaining on the data stack are processed before the READY mode message is displayed. These remaining elements are treated as TSO/E commands to be issued. If the element is not a TSO/E command (or an implicit exec or CLIST to be run), you see the message:

```
COMMAND command_name NOT FOUND
```

- Information the EXECIO command reads from and writes to data sets when performing I/O.

For information about the EXECIO command and how it uses the data stack, see “Using EXECIO to Process Information to and from Data Sets” on page 154.

Using the Data Stack

The data stack has some unique characteristics, such as:

- It can contain a virtually unlimited number of data items of virtually unlimited size.
- It can contain commands to be issued after the exec ends.
- It can pass information between REXX execs and other types of programs in a TSO/E or non-TSO/E address space.

Because of the data stack's unique characteristics, you can use the data stack specifically to:

- Store a large number of data items for a single exec's use.
- Pass a large number of arguments or an unknown number of arguments between a routine (subroutine or function) and the main exec.
- Pass responses to an interactive command that can run after the exec ends.
- Store data items from an input data set, which were read by the EXECIO command. For information about the EXECIO command, see “Using EXECIO to Process Information to and from Data Sets” on page 154.
- Share information between an exec and any program running in MVS. For more information about running REXX execs in MVS, see “Chapter 13. Using REXX in TSO/E and Other MVS Address Spaces” on page 171.
- Execute subcommands of a TSO/E command issued from a REXX exec.

Passing Information Between a Routine and the Main Exec

You can use the data stack to pass information from an exec to an external routine without using arguments. The exec pushes or queues the information on the stack and the routine pulls it off and uses it as in the following example.

Example of Using the Data Stack to Pass Information

```

/***** REXX *****/
/* This exec helps an inexperienced user allocate a new PDS. It */
/* prompts the user for the data set name and approximate size, */
/* and queues that information on the data stack. Then it calls */
/* an external subroutine called newdata. */
/*****/

message = 'A data set name for a partitioned data set has three',
'qualifiers separated by periods. The first qualifier is usually',
'a user ID. The second qualifier is any name. The third qualifier',
'is the type of data set, such as "exec". Generally the user ID',
'is assumed, so you might specify a data set name as MYREXX.EXEC.',
'A new data set name cannot be the same as an existing data set',
'name. Please type a name for the new data set or type QUIT to end.'

SAY 'What is the new data set name? If you are unsure about'
SAY 'naming data sets, type ?. To end, type QUIT.'

PULL name
DO WHILE (name = '?') | (name = 'QUIT')
  IF name = '?' THEN
    DO
      SAY message
      PULL name
    END
  ELSE
    EXIT
END

SAY 'Approximately how many members will the data set have:'
SAY '6 12 18 24 30 36 42 48 54 60?'

PULL number
QUEUE name
QUEUE number
CALL newdata

IF RESULT > 0 THEN
  SAY 'An error prevented' name 'from being allocated.'
ELSE
  SAY 'Your data set' name 'has been allocated.'

```

Example of the External Subroutine NEWDATA

```

/***** REXX *****/
/* This external subroutine removes the data set name and the */
/* number of members from the stack and then issues the ALLOCATE */
/* command. */
/*****/

PULL name
PULL number

"ALLOCATE DATASET("name") NEW SPACE(50,20) DIR("number%6") DSORG(P0)",
"RECFM(V,B) LRECL(255) BLKSIZE(5100)"

RETURN RC /* The return code from the TS0/E command sets the */
          /* REXX special variable, RC, and is returned to the */
          /* calling exec. A 0 return code means no errors. */

```

Using the Data Stack

Passing Information to Interactive Commands

When your TSO/E profile allows prompting, most TSO/E commands prompt you for missing operands. For example, the TRANSMIT command prompts you for a node and user ID when you do not include the destination with the command.

An exec can put responses to command prompts on the data stack. Because of the information search order, the data stack supplies the necessary information instead of a user at the terminal.

For example, the following exec puts the TRANSMIT command and its operands on the data stack. When the exec completes, the TSO/E data stack service continues to get input from the data stack. Thus the TRANSMIT command is issued after the exec ends.

Issuing Subcommands of TSO/E Commands

To execute subcommands of a TSO/E command in a REXX exec, you must place the subcommands onto the data stack before you issue the TSO/E command.

Example of Passing Information from the Stack to a Command

```
/****** REXX *****/
/* This exec prompts a user for a node and gets the user ID from a */
/* built in function. It then calls an external subroutine to */
/* check if the user's job is finished. */
/* The TRANSMIT command and its operands, including a message with */
/* the status of the job, are queued on the data stack to run after*/
/* the exec terminates. */
/*******/

SAY 'What is your node?'
PULL node
id = USERID()
dest = node'.'id

CALL jobcheck userid /* Go to a subroutine that checks job status */

IF RESULT = 'done' THEN
    note = 'Your job is finished.'
ELSE
    note = 'Your job is not finished.'

QUEUE 'transmit'
QUEUE dest 'line' /* Specify that the message be in line mode */
QUEUE note
QUEUE '' /* Insert a null to indicate line mode is over */
```

Creating a Buffer on the Data Stack

When an exec calls a routine (subroutine or function) and both the exec and the routine use the data stack, the stack becomes a way to share information. However, execs and routines that do not purposely share information from the data stack, might unintentionally do so and end in error. To help prevent this, TSO/E provides the MAKEBUF command that creates a buffer, which you can think of as an extension to the stack, and the DROPBUF command that deletes the buffer and all elements within it.

Creating a Buffer on the Data Stack

Although the buffer does not prevent the PULL instruction from accessing elements placed on the stack before the buffer was created, it is a way for an exec to create a temporary extension to the stack. The buffer allows an exec to:

1. Use the QUEUE instruction to insert elements in FIFO order on a stack that already contains elements.
2. Have temporary storage that it can delete easily with the DROPBUF command.

An exec can create multiple buffers before dropping them. Every time MAKEBUF creates a new buffer, the REXX special variable RC is set with the number of the buffer created. Thus if an exec issues three MAKEBUF commands, RC is set to 3 after the third MAKEBUF command.

Note: To protect elements on the stack, an exec can create a new stack with the NEWSTACK command. For information about the NEWSTACK command, see “Protecting Elements in the Data Stack” on page 147.

Creating a Buffer with the MAKEBUF Command

To create a buffer on the data stack before adding more elements to the stack, use the TSO/E REXX MAKEBUF command. All elements added to the data stack after the MAKEBUF command are placed in the buffer. Below the buffer are elements placed on the stack before the MAKEBUF command.

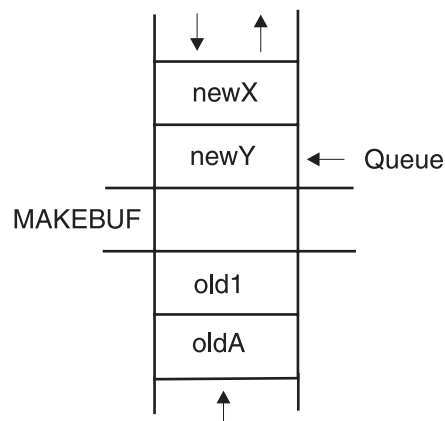

Instructions that could be used to create the illustrated buffer are as follows:

```
'MAKEBUF'  
PUSH 'newX'  
QUEUE 'newY'
```

Removing Elements from a Stack with a Buffer

The buffer created by MAKEBUF does not prevent an exec from accessing elements below it. After an exec removes the elements added after the MAKEBUF command, then it removes elements added before the MAKEBUF command was issued.

Using the previous illustration, when the exec issues three PULL instructions, the following elements are removed from the data stack.

```
newX  
newY  
old1
```

Creating a Buffer on the Data Stack

To prevent a routine from accessing elements below the buffer, you can use the QUEUED built-in function as follows:

```
olditems = QUEUED()
'MAKEBUF'
PUSH ...
QUEUE ...
DO WHILE QUEUED() > olditems /* total items > old number of items */
  PULL ....
  ...
END
'DROPBUF'
```

Dropping a Buffer with the DROPBUF Command

When an exec has no more need for a buffer on the data stack, it can use the TSO/E REXX DROPBUF command to remove the buffer (and its contents). The DROPBUF command removes the most recently created buffer.

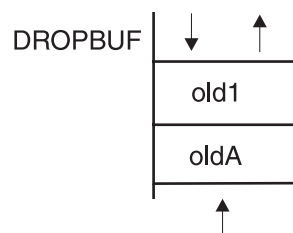

To drop a specific buffer on the data stack and all buffers created after it, issue the DROPBUF command with the number of the buffer. The first MAKEBUF creates buffer 1, the second creates buffer 2, and so on. For example, if an exec issued three MAKEBUF commands that created three buffers, when you issue DROPBUF 2, the second and third buffers and all elements within them are removed.

To remove all elements from the entire data stack including elements placed on the data stack before buffers were added, issue DROPBUF 0. DROPBUF 0 creates an empty data stack and should be used with caution.

Note: When an element is removed below a buffer, the buffer disappears. Thus when elements are unintentionally removed below a buffer, the corresponding DROPBUF command might remove the incorrect buffer and its elements. To prevent an exec from removing elements below a buffer, use the QUEUED built-in function or use the NEWSTACK command as described in “Protecting Elements in the Data Stack” on page 147.

Finding the Number of Buffers with the QBUF Command

To find out how many buffers were created with the MAKEBUF command, use the TSO/E REXX QBUF command. QBUF returns in the REXX special variable RC, the number of buffers created.

```
'MAKEBUF'
  ⋮
'MAKEBUF'
  ⋮
'QBUF'
SAY 'The number of buffers is' RC /* RC = 2 */
```

Creating a Buffer on the Data Stack

QBUF returns the total number of buffers created, not just the ones created by a single exec. Thus if an exec issued two MAKEBUF commands and called a routine that issued two more, when the routine issues a QBUF command, RC returns the total number of buffers created, which is four.

Finding the Number of Elements In a Buffer

To find out how many elements are in the most recently created buffer, use the TSO/E REXX QELEM command. QELEM returns in the REXX special variable RC, the number of elements in the most recently created buffer.

```
PUSH A
'MAKEBUF'
PUSH B
PUSH C
'QELEM'
SAY 'The number of elements is' RC                /* RC = 2 */
```

QELEM does not return the number of elements on a data stack with no buffers created by the MAKEBUF command. If QBUF returns 0, no matter how many elements are on the stack, QELEM also returns 0.

For more information about these stack commands, see *z/OS TSO/E REXX Reference*.

Exercises - Creating a Buffer on the Data Stack

1. What are the results of the following instructions?

a. What is item?

```
QUEUE A
QUEUE B
'MAKEBUF'
QUEUE C
PULL item
```

b. What is element?

```
PUSH 'a'
PUSH 'b'
'MAKEBUF'
PUSH 'c'
PUSH 'd'
'DROPBUF'
PARSE PULL element
```

c. What is stackitem?

```
QUEUE a
'MAKEBUF'
QUEUE b
'MAKEBUF'
QUEUE c
'DROPBUF'
PULL stackitem
```

d. What is RC?

```
PUSH A
'MAKEBUF'
PUSH B
CALL sub1
'QBUF'
SAY RC
EXIT
```

Creating a Buffer on the Data Stack

```
sub1:
  'MAKEBUF'
  RETURN
```

e. What is RC?

```
QUEUE A
  'MAKEBUF'
PUSH B
PUSH C
  'MAKEBUF'
PUSH D
  'QELEM'
SAY RC
```

f. What is RC?

```
QUEUE A
QUEUE B
QUEUE C
  'QELEM'
SAY RC
```

2. Given the data stack below and the instructions that created it, what are the results of the subsequent instructions that follow?

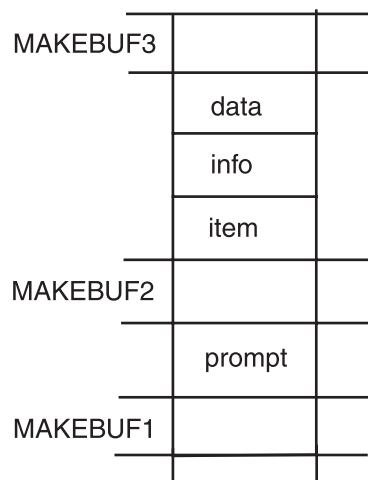

```
'MAKEBUF'
QUEUE 'prompt'
'MAKEBUF'
QUEUE 'data'
QUEUE 'info'
QUEUE 'item'
'MAKEBUF'
```

a. What is returned to the function?

```
SAY QUEUED()
```

b. What is RC?

```
'QBUF'
SAY RC
```

c. What is RC?

```
'QELEM'
SAY RC
```

d. What are both RCs and the result of the QUEUED() function?

```
'DROPBUF 2'  
'QBUF'  
SAY RC  
'QELEM'  
SAY RC  
SAY QUEUED()
```

ANSWERS

1.
 - a. C
 - b. b
 - c. B (b was changed to uppercase because it was queued without quotes and pulled without PARSE.)
 - d. 2
 - e. 1
 - f. 0
2.
 - a. 4
 - b. 3
 - c. 0
 - d. 1, 1, 1

Protecting Elements in the Data Stack

In certain environments, particularly MVS, where multiple tasks run at the same time, it is often important for an exec to isolate stack elements from other execs.

Similarly, an exec in TSO/E might want to protect stack elements from a routine (subroutine or function) that it calls. For example, if an exec puts elements on the data stack for its own use and then calls a subroutine that issues an interactive TSO/E command, such as ALLOCATE, the command goes to the data stack first for input to the command. Because the stack input is incorrect for the command prompt, the exec ends in error.

Example of an Interactive Command Error

```
EXEC1  
  
PUSH prompt1  
PUSH prompt2  
CALL sub1  
?invellip.  
EXIT  
  
SUB1:  
  
'MAKEBUF'  
'ALLOCATE'  
⋮
```

Even though the subroutine in the preceding example starts with the MAKEBUF command, the stack elements will be used because MAKEBUF does not protect elements previously placed on the stack.

Protecting Elements in the Data Stack

To protect elements on the data stack, you can create a new data stack with the TSO/E REXX NEWSTACK command. Read the next section to see how the exec in the previous example can safely issue an interactive TSO/E command.

To delete the new data stack and all elements in it, use the TSO/E REXX DELSTACK command. Execs can create multiple stacks before deleting them.

Note: Before an exec returns to its caller, the called exec should issue a DELSTACK command for each NEWSTACK command it issued, unless the called exec intends for the caller to also use the new data stack.

Creating a New Data Stack with the NEWSTACK Command

The TSO/E REXX NEWSTACK command creates a private data stack that is completely isolated from the original data stack. The elements on the original data stack cannot be accessed by an exec or the routines that it calls until a DELSTACK command is issued. When there are no more elements in the new data stack, information is taken from the terminal.

Note: When you issue the NEWSTACK, it is your responsibility to issue a corresponding DELSTACK command.

All elements added to the data stack after the NEWSTACK command are placed in the new data stack. The original stack contains the elements placed on the stack before the NEWSTACK command.

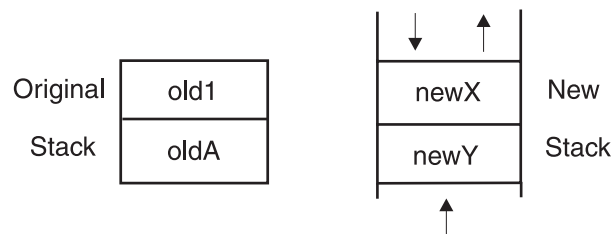

Instructions that could be used to create the illustrated new stack are as follows:

```
PUSH 'oldA'  
PUSH 'old1'  
'NEWSTACK'  
QUEUE 'newY'  
PUSH 'newX'
```

In the Example of an Interactive Command Error, the MAKEBUF command did not protect the elements in the stack. If you substitute the NEWSTACK command for the MAKEBUF command, the elements become inaccessible.

Example of using NEWSTACK with an Interactive Command

```
EXEC1

PUSH prompt1
PUSH prompt2
CALL sub1
  ⋮

EXIT

SUB1:

'NEWSTACK'
'ALLOCATE'
  ⋮
```

Note: To have an interactive command prompt the user for input from the terminal, run an exec explicitly with the EXEC command and specify prompt or include the PROMPT(on) function within the exec. For more information, see “Causing Interactive Commands to Prompt the User” on page 100.

Deleting a Private Stack with the DELSTACK Command

When an exec wants to delete the new stack and remove all elements placed on the new stack, it can issue the TSO/E REXX DELSTACK command. The DELSTACK command removes the most recently created data stack. If no stack was previously created with the NEWSTACK command, DELSTACK **removes all the elements from the original stack.**

Finding the Number of Stacks

To find out how many stacks exist, use the TSO/E REXX QSTACK command. QSTACK returns in the REXX special variable RC, the total number of stacks including the original data stack.

```
'NEWSTACK'
  ⋮

'NEWSTACK'
  ⋮

'QSTACK'
SAY 'The number of stacks is' RC           /* RC contains 3 */
```

QSTACK returns the total number of stacks, not just the ones created for a single exec. Thus if an exec issued two NEWSTACK commands and called a routine that issued two more, when the routine issues a QSTACK command, RC returns the total number of stacks, which is five.

For more information about these commands, see *z/OS TSO/E REXX Reference*.

Protecting Elements in the Data Stack

Additional Examples

Data Stack Example 1

```
/****** REXX ******/
/* This exec tests several of the stack functions to see how they */
/* work together. It uses the NEWSTACK and DELSTACK commands, puts */
/* an element on the stack that exceeds 255 characters, uses the */
/* LENGTH built-in function to see how long the element is, uses */
/* QUEUED built-in function to see how many items are on the stack,*/
/* and then issues more PULL instructions than are elements on the */
/* stack. */
/*******/
element = 'Attention please! This is a test.'
PUSH element

'NEWSTACK' /* Create a new stack and protect elements previously */
           /* placed on the stack */

longitem = 'SAA is a definition -- a set of software interfaces,',
'conventions, and protocols that provide a framework for designing',
'and developing applications with cross-system consistency.',
'The Systems Application Architecture defines a common programming',
'interface you can use to develop applications, and defines common',
'communications support that you can use to connect those',
'applications.'

SAY 'The length of the element is' LENGTH(longitem) 'characters.'
           /* The length of the element is 379 characters. */
QUEUE longitem

PULL anyitem
SAY anyitem /* Displays the longitem quote in uppercase */

SAY 'There are' QUEUED() 'number of elements on the stack.'
           /* The QUEUED function returns 0 */

PULL emptyitem /* Pull an element from an empty stack. Results in */
               /* a blank screen and PULL waits for terminal */
               /* input. To end the wait, press ENTER. */

'DELSTACK' /* Remove the new stack and return to original stack.*/

PULL anyitem
SAY anyitem /* Displays ATTENTION PLEASE! THIS IS A TEST. */
```

Data Stack Example 2

```

/***** REXX *****/
/* This exec runs another exec implicitly and then sends a message */
/* when the called exec finishes. It receives as an argument the */
/* name of a PDS member to run. It activates the system procedure */
/* file SYSEXEC, allocates the data set to SYSEXEC, pushes some */
/* commands on the data stack and then implicitly executes the exec*/
/*****/

ARG dsn

"EXECUTIL SEARCHDD(yes)" /* Establish the system library SYSEXEC*/

PUSH "SEND 'Sequence over' USER(*)" /* Put a message on the stack*/
PUSH "TIME" /* Push the time command */
PUSH "FREE F(SYSEXEC)" /* Push command to free SYSEXEC*/

PARSE VAR dsn name '(' member /* Separate the data set name from */
/* the member name. */

"ALLOC DA("name") F(SYSEXEC) SHR REUSE"

execname = STRIP(member,t,')') /* Remove the last parentheses from*/
/* the member name. */

PUSH '%execname /* Put the member name on the stack*/

/*****/
/* The output from this exec depends on the exec that it runs. */
/* Output can be as follows: */
/* */
/*TIME-01:23:56 PM.CPU-00:00:23 SERVICE-297798 SESSION-04:15:20 MAY*/
/*12,1989 */
/* Sequence over USERID */
/* READY */
/*****/

```

Protecting Elements in the Data Stack

Chapter 12. Processing Data and Input/Output Processing

Types of Processing	153
Dynamic Modification of a Single REXX Expression	153
Using the INTERPRET Instruction	153
Using EXECIO to Process Information to and from Data Sets	154
When to Use the EXECIO Command	154
Using the EXECIO Command	154
Reading Information from a Data Set	155
Writing Information to a Data Set.	157
Return Codes from EXECIO	159
When to Use the EXECIO Command	159
Copying Information From One Data Set to Another	159
Copying Information to and from a List of Compound Variables.	161
Updating Information in a Data Set	162
Additional Examples	163

This chapter describes dynamic modification of a single REXX expression and I/O processing of data sets.

Types of Processing

The word "processing" is used here to mean the performance of operations and calculations on data. Normal processing of instructions in REXX occurs every time the language processor evaluates an expression. This chapter describes two special types of REXX processing:

- Dynamic modification of a single REXX expression
 The INTERPRET instruction evaluates an expression and then treats it as a REXX instruction.
- Processing information to and from data sets
 The TSO/E REXX EXECIO command in an exec reads information from a data set to the data stack (or a list of variables) and writes information from the data stack (or list of variables) back to a data set.

Dynamic Modification of a Single REXX Expression

Typically REXX expressions are evaluated and the result replaces the expression. For example, the arithmetic expression "5 + 5" is evaluated as "10".

```
answer = 5 + 5                                /* answer gets the value 10 */
```

If the arithmetic expression is in quotation marks, the expression is evaluated as a string.

```
answer = '5 + 5'                              /* answer gets the value 5 + 5 */
```

To both evaluate and execute an expression, you can use the INTERPRET instruction.

Using the INTERPRET Instruction

The INTERPRET instruction not only evaluates an expression, but also treats it as an instruction after it is evaluated. Thus if a combination of the previous examples were used with the INTERPRET instruction, answer becomes "10".

Dynamic Modification of a Single REXX Expression

```
answer = 5 + 5
INTERPRET 'say' answer '"= 5 + 5"'          /* displays 10 = 5 + 5 */
```

You can also group a number of instructions within a string, assign the string to a variable, and use the INTERPRET instruction to execute the instructions assigned to the variable.

```
action = 'DO 3; SAY "Hello!"; END'
INTERPRET action                          /* results in:
                                           Hello!
                                           Hello!
                                           Hello! */
```

Because the INTERPRET instruction causes dynamic modification, use it very carefully. For more information about the INTERPRET instruction, see *z/OS TSO/E REXX Reference*.

Using EXECIO to Process Information to and from Data Sets

An exec uses the EXECIO command to perform the input and output (I/O) of information to and from a data set. The information can be stored in the data stack for serialized processing or in a list of variables for random processing.

When to Use the EXECIO Command

The various operands and combination of operands of the EXECIO command permit you to do many types of I/O. For example, you can use the EXECIO command to:

- Read information from a data set
- Write information to a data set
- Open a data set without reading or writing any records
- Empty a data set
- Copy information from one data set to another
- Copy information to and from a list of compound variables
- Add information to the end of a sequential data set
- Update information in a data set one line at a time

Using the EXECIO Command

EXECIO reads information from a data set with either the DISKR or DISKRU operands. Using these operands, you can also open a data set without reading its records. Refer to Reading Information from a Data Set for more information about the DISKR and DISKRU operands. EXECIO writes information to a data set with the DISKW operand. Using this operand, you can also open a data set without writing records or empty an existing data set. Refer to “Writing Information to a Data Set” on page 157 for more information on the DISKW operand.

Before an exec can use the EXECIO command to read from or write to a data set, the data set must meet the following requirements. An I/O data set must be:

- Either sequential or a single member of a PDS.
- Previously allocated with the appropriate attributes for its specific purpose. Some examples of the various uses of EXECIO and the type of data set allocation appropriate for these uses are shown in and after “Copying Information From One Data Set to Another” on page 159.

If you use EXECIO to read information from a data set and to the data stack, the information can be stored in FIFO or LIFO order on the data stack. FIFO is the

default. If you use EXECIO to read information from a data set and to a list of variables, the first data set line is stored in variable1, the second data set line is stored in variable2, and so on. Data read into a list of variables can be accessed randomly. After the information is in the data stack or in a list of variables, the exec can test it, copy it to another data set, or update it before returning it to the original data set.

Reading Information from a Data Set

To read information from a data set to the data stack or to a list of variables, use EXECIO with either the DISKR or DISKRU operand. A typical EXECIO command to read all lines from the data set allocated to the ddname MYINDD, might appear as:

```
"EXECIO * DISKR myindd (FINIS"
```

The rest of this topic describes the types of information you can specify with EXECIO DISKR and EXECIO DISKRU. For further information, see *z/OS TSO/E REXX Reference*.

How to specify the number of lines to read: To open a data set without reading any records, put a zero immediately following the EXECIO command and specify the OPEN operand.

```
"EXECIO 0 DISKR mydd (OPEN"
```

To read a specific number of lines, put the number immediately following the EXECIO command.

```
"EXECIO 25 ..."
```

To read the entire data set, put an asterisk immediately following the EXECIO command.

```
"EXECIO * ..."
```

When all the information is on the data stack, either queue a null line to indicate the end of the information, or if there are null lines throughout the data, assign the built-in QUEUED() function to a variable to indicate the number of items on the stack.

How to read the data set: Depending on the purpose you have for the input data set, use either the DISKR or DISKRU operand.

- DISKR - Reading Only

To initiate I/O from a data set that you want to read only, use the DISKR operand with the FINIS option. The FINIS option closes the data set after the information is read. Closing the data set allows other execs to access the data set and the ddname.

```
"EXECIO * DISKR ... (FINIS"
```

Note: Do not use the FINIS option if you want the next EXECIO statement in your exec to continue reading at the line immediately following the last line read.

- DISKRU - Reading and Updating

To initiate I/O to a data set that you want to both read and update, use the DISKRU operand without the FINIS option. Because you can update only the last line that was read, you usually read and update a data set one line at a time, or go immediately to the single line that needs updating. The data set remains open while you update the line and return the line with a corresponding EXECIO DISKW command.

Using EXECIO to Process Information ...

```
"EXECIO 1 DISKRU ..."
```

More about using DISKRU appears in "Updating Information in a Data Set" on page 162.

How to access the data set: An I/O data set must first be allocated to a ddname. The ddname need not exist previously. In fact, it might be better to allocate it to a new ddname, such as MYINDD, in order not to interfere with previously established allocations. You can allocate before the exec runs, or you can allocate from within the exec with the ALLOCATE command as shown in the following example.

```
"ALLOC DA(io.data) F(myindd) SHR REUSE"  
"EXECIO * DISKR myindd (FINIS"
```

Option of specifying a starting line number: If you want to start reading at other than the beginning of the data set, specify the line number at which to begin. For example, to read all lines to the data stack starting at line 100, add the following line number operand.

```
"EXECIO * DISKR myindd 100 (FINIS"
```

To read just 5 lines to the data stack starting at line 100, write the following:

```
"EXECIO 5 DISKR myindd 100 (FINIS"
```

To open a data set at line 100 without reading lines to the data stack, write the following:

```
"EXECIO 0 DISKR myindd 100 (OPEN"
```

Options for DISKR and DISKRU: Options you can use are:

- OPEN - To open a data set. When you specify OPEN with EXECIO 0, it opens the data set and positions the file position pointer before the first record.

```
"EXECIO 0 DISKR myindd (OPEN"
```

Note: If the data set is already open, no operation is performed for OPEN.

- FINIS - To close the data set after reading it. Closing the data set allows other execs to access it and its ddname. It also resets the current positional pointer to the beginning of the data set.
- STEM - To read the information to either a list of compound variables that can be indexed, or a list of variables appended with numbers. Specifying STEM with a variable name ensures that a list of variables (not the data stack) receives the information.

```
"EXECIO * DISKR myindd (STEM newvar."
```

In this example, the list of compound variables has the stem newvar. and lines of information or records from the data set are placed in variables newvar.1, newvar.2, newvar.3, and so forth. The number of items in the list of compound variables is placed in the special variable newvar.0.

Thus if 10 lines of information are read into the newvar variables, newvar.0 contains the number 10, indicating that 10 records have been read. Furthermore, newvar.1 contains record 1, newvar.2 contains record 2, and so forth up to newvar.10 which contains record 10. All stem variables beyond newvar.10 (for example, variables newvar.11 and newvar.12) are residual and contain the value(s) held prior to entering the EXECIO command.

Using EXECIO to Process Information ...

To avoid confusion as to whether a residual stem variable value is meaningful, you may want to clear the entire stem variable prior to entering the EXECIO command. To clear all stem variables, you can either:

- Use the DROP instruction as follows, which sets all stem variables to their uninitialized state.

```
DROP newvar.
```

- Set all stem variables to nulls as follows:

```
newvar. = '
```

See EXECIO Example 6 under the heading Figure 7 on page 168, which shows the usage of the EXECIO command with stem variables.

- SKIP - To skip over a specified number of lines in a data set without placing them on the data stack or into variables.

```
"EXECIO 24 DISKR myindd (SKIP"
```

- LIFO - To read the information in LIFO order onto the stack. In other words, use the PUSH instruction to place the information on the stack.
- FIFO - To read the information in FIFO order onto the stack. In other words, use the QUEUE instruction to place the information on the stack. If you do not specify either LIFO or FIFO, FIFO is assumed.

Writing Information to a Data Set

To write information to a data set from the data stack or from a list of variables, use EXECIO with the DISKW operand. A typical EXECIO command to write all lines to the data set allocated to the ddname, MYOUTDD, might appear as:

```
"EXECIO * DISKW myoutdd (FINIS"
```

The rest of this topic describes the types of information you can specify with EXECIO DISKW. For further information, see *z/OS TSO/E REXX Reference*.

How to specify the number of lines to write: To open a data set without writing records to it, put a zero immediately following the EXECIO command and specify the OPEN operand.

```
"EXECIO 0 DISKW myoutdd ... (OPEN"
```

Notes:

1. To empty a data set, issue this command to open the data set and position the file position pointer before the first record. You then issue EXECIO 0 DISKW myoutdd ... (FINIS to write an end-of-file mark and close the data set. This deletes all records in data set MYOUTDD. You can also empty a data set by issuing EXECIO with both the OPEN and FINIS operands.
2. When you empty a data set, the file to which the data set is allocated should not have a disposition of MOD. If the file has a disposition of MOD, opening and then closing the data set will not empty the data set.

To write a specific number of lines, put the number immediately following the EXECIO command.

```
"EXECIO 25 DISKW ..."
```

To write the entire data stack or until a null line is found, put an asterisk immediately following the EXECIO command.

```
"EXECIO * DISKW ..."
```

Using EXECIO to Process Information ...

When you specify *, the EXECIO command will continue to pull items off the data stack until it finds a null line. If the stack becomes empty before a null line is found, EXECIO will prompt the terminal for input until the user enters a null line. Thus when you do not want to have terminal I/O, queue a null line at the bottom of the stack to indicate the end of the information.

```
QUEUE '
```

If there are null lines (lines of length 0) throughout the data and the data stack is not shared, you can assign the built-in QUEUED() function to a variable to indicate the number of items on the stack.

```
n = QUEUED()
"EXECIO" n "DISKW outdd (FINIS"
```

How to access the data set: An I/O data set must first be allocated to a ddname. The ddname does not need to exist previously. In fact, it might be better to allocate to a new ddname, such as MYOUTDD, in order not to interfere with previously established allocations. You can allocate from within the exec with the ALLOCATE command as shown in the following example, or you can allocate before the exec runs.

```
"ALLOC DA(out.data) F(myoutdd) OLD REUSE"
"EXECIO * DISKW myoutdd ..."
```

Options for DISKW: Options you can use are:

- OPEN - To open a data set. When you specify OPEN with EXECIO 0, it opens the data set and positions the file position pointer before the first record.

```
"EXECIO 0 DISKW myoutdd (OPEN"
```

Note: If the data set is already open, no operation is performed for OPEN.

- FINIS - To close the data set after writing to it. Closing the data set allows other execs to access it and its ddname. When you specify FINIS, it forces the completion of all I/O operations by physically writing the contents of any partially filled I/O buffers to the data set.

```
"EXECIO * DISKW myoutdd (FINIS"
```

- STEM - To write the information from compound variables or a list of variables beginning with the name specified after the STEM keyword. The variables, instead of the data stack, holds the information to be written.

```
"EXECIO * DISKW myoutdd (STEM newvar."
```

In this example, the variables would have the stem newvar. and lines of information from the compound variables would go to the data set. Each variable is labeled newvar.1, newvar.2, newvar.3, and so forth.

The variable newvar.0 is not used when writing from compound variables. When * is specified with a stem, the EXECIO command stops writing information to the data set when it finds a null value or an uninitialized compound variable. In this case, if the list contained 10 compound variables, the EXECIO command stops at newvar.11.

The EXECIO command can also specify the number of lines to write from a list of compound variables.

```
"EXECIO 5 DISKW myoutdd (STEM newvar."
```

In this example, the EXECIO command writes 5 items from the newvar variables including uninitialized compound variables, if any.

See EXECIO Example 6 under the heading Figure 7 on page 168, which shows the usage of the EXECIO command with stem variables.

Return Codes from EXECIO

After an EXECIO command runs, it sets the REXX special variable "RC" to a return code. Valid return codes from EXECIO are:

Return Code	Meaning
0	Normal completion of requested operation.
1	Data was truncated during DISKW operation.
2	End-of-file reached before the specified number of lines were read during a DISKR or DISKRU operation. (This return code does not occur when * is specified for number of lines because the remainder of the file is always read.)
4	An empty data set was found within a concatenation of data sets during a DISKR or DISKRU operation. The file was not successfully opened and no data was returned.
20	Severe error. EXECIO completed unsuccessfully and a message is issued.

When to Use the EXECIO Command

The various operands and combination of operands of the EXECIO command permit you to do many types of I/O. For example, you can use the EXECIO command to:

- Copy information from one data set to another
 - Copy an entire data set
 - Copy parts of a data set
 - Add information to the end of a sequential data set
- Copy information to and from a list of compound variables
- Update information in a data set

Copying Information From One Data Set to Another

Before you can copy one data set to another, the data sets must be either sequential data sets or members of a PDS, and they must be pre-allocated. Following are examples of ways to allocate and copy data sets using the EXECIO command.

Copying an entire data set: To copy an entire existing sequential data set named 'USERID.MY.INPUT' into a new sequential data set named 'USERID.NEW.INPUT', and to use the ddnames DATAIN and DATAOUT respectively, you could use the following instructions. (Remember that when the first qualifier of a data set name is your prefix (usually your user ID), you can omit the first qualifier.)

Using EXECIO to Process Information ...

Copying an Entire Data Set

```
"ALLOC DA(my.input) F(datain) SHR REUSE"  
"ALLOC DA(new.input) F(dataout) LIKE(my.input) NEW"  
"NEWSTACK" /* Create a new data stack for input only */  
"EXECIO * DISKR datain (FINIS"  
QUEUE ' ' /* Add a null line to indicate the end of the information */  
"EXECIO * DISKW dataout (FINIS"  
"DELSTACK" /* Delete the new data stack */  
"FREE F(datain dataout)"
```

If the null line was not queued at the end of the information on the stack, the EXECIO command would go to the terminal to get more information and would not end until the user entered a null line.

Another way to indicate the end of the information when copying an entire data set, is with the QUEUED() built-in function. If the data set is likely to include null lines throughout the data, using the QUEUED() function is preferable.

```
n = QUEUED() /* Assign the number of stack items to "n" */  
"EXECIO" n "DISKW dataout (FINIS"
```

Also, when copying an undetermined number of lines to and from the data stack, it is a good idea to use the NEWSTACK and DELSTACK commands to prevent removing items previously placed on the stack. For more information about these commands, see “Protecting Elements in the Data Stack” on page 147.

Copying a specified number of lines to a new data set: To copy 10 lines of data from an existing sequential data set named 'DEPT5.STANDARD.HEADING' to a new member in an existing PDS named 'USERID.OFFICE.MEMO(JAN15)', and use the ddnames INDD and OUTDD respectively, you could use the following instructions. (Remember that a data set name that does not begin with your prefix must be enclosed in single quotes.)

Copying 10 Lines of Data to a New Data Set

```
"ALLOC DA('dept5.standard.heading') F(indd) SHR REUSE"  
"ALLOC DA(office.memo(jan15)) F(outdd) SHR REUSE"  
"EXECIO 10 DISKR indd (FINIS"  
"EXECIO 10 DISKW outdd (FINIS"
```

To copy the same 10 lines of data to a list of compound variables with the stem "data.", substitute the following EXECIO commands.

```
"EXECIO 10 DISKR indd (FINIS STEM DATA."  
"EXECIO 10 DISKW outdd (FINIS STEM DATA."
```

Note: When copying information to more than one member of a PDS, only one member of the PDS should be open at a time.

Adding 5 lines to the end of an existing sequential data set: To add 5 lines from an existing data set member named 'USERID.WEEKLY.INPUT(MAR28)' to the end of an existing sequential data set named 'USERID.YEARLY.OUTPUT', and use the ddnames MYINDD and MYOUTDD respectively, you could write the following instructions. Note the "MOD" attribute on the second allocation, which appends the 5 lines at the end of the data set rather than on top of existing data.

Appending 5 Lines of Data to an Existing Data Set

```
"ALLOC DA(weekly.input(mar28)) F(myindd) SHR REUSE"
"ALLOC DA(yearly.output) F(myoutdd) MOD"
"EXECIO 5 DISKR myindd (FINIS"
"EXECIO 5 DISKW myoutdd (FINIS"
```

Note: Do not use the MOD attribute when allocating a member of a PDS to which you want to append information. You can use MOD only when appending information to a sequential data set. To append information to a member of a PDS, rewrite the member with the additional records added.

Copying Information to and from a List of Compound Variables

When copying information from a data set, you can store the information in the data stack, which is the default, or you can store the information in a list of compound variables. Similarly, when copying information back to a data set, you can remove information from the data stack, which is the default, or you can remove the information from a list of compound variables.

Copying Information from a Data Set to a List of Compound Variables: To copy an entire data set into compound variables with the stem `newvar.`, and then display the list, write the following instructions.

Copying an Entire Data Set into Compound Variables

```
"ALLOC DA(old.data) F(indd) SHR REUSE"
"EXECIO * DISKR indd (STEM newvar."
DO i = 1 to newvar.0
  SAY newvar.i
END
```

When you want to copy a varying number of lines to compound variables, you can use a variable within the EXECIO command as long as the variable is not within quotation marks. For example, the variable `lines` can represent the number of lines indicated when the exec is run.

Copying a Varying Number of Lines into Compound Variables

```
ARG lines
"ALLOC DA(old.data) F(indd) SHR REUSE"
"EXECIO" lines "DISKR indd (STEM newvar."
```

Copying Information from Compound Variables to a Data Set: To copy 10 compound variables with the stem `newvar.`, regardless of how many items are in the list, write the following instructions.

Note: An uninitialized compound variable will default to the value of its name. For example, if `newvar.9` and `newvar.10` do not contain values, the data set will receive the values `NEWVAR.9` and `NEWVAR.10`.

Using EXECIO to Process Information ...

Copying from Compound Variables

```
"ALLOC DA(new.data) F(outdd) LIKE(old.data) NEW"  
"EXECIO 10 DISKW outdd (STEM NEWVAR.)"
```

Updating Information in a Data Set

You can update a single line of a data set with the EXECIO command, or you can update multiple lines. Use the DISKRU form of the EXECIO command to read information that you may subsequently update.

Note: The line written must be the same length as the line read. When a changed line is longer than the original line, information that extends beyond the original number of bytes is truncated and EXECIO sends a return code of 1. If lines must be made longer, write the data to a new data set. When a changed line is shorter than the original line, it is padded with blanks to attain the original line length.

Updating a single line: When updating a single line in a data set, it is more efficient to locate the line in advance and specify the update to it rather than read all the lines in the data set to the stack, locate and change the line, and then write all the lines back.

For example, you have a data set named 'DEPT5.EMPLOYEE.LIST' that contains a list of employee names, user IDs, and phone extensions.

Adams, Joe	JADAMS	5532
Crandall, Amy	AMY	5421
Devon, David	DAVIDD	5512
Garrison, Donna	DONNAG	5514
Leone, Mary	LEONE1	5530
Sebastian, Isaac	ISAAC	5488

To change a phone extension to 5500 on a particular line, such as Amy Crandall's, specify the line number, in this case, 2, and write the following instructions. Notice the "OLD" attribute on the allocation. The "OLD" attribute guarantees that no one else can use the data set while you are updating it.

Updating a Specific Line in a Data Set

```
"ALLOC DA('dept5.employee.list') F(updatedd) OLD"  
"EXECIO 1 DISKRU updatedd 2 (LIFO"  
PULL line  
PUSH 'Crandall, Amy          AMY          5500'  
"EXECIO 1 DISKW updatedd (FINIS"  
"FREE F(updatedd)"
```

Updating multiple lines: To update multiple lines, you can issue more than one EXECIO command to the same data set. For example, to update Mary Leone's user ID in addition to Amy Crandall's phone extension, write the following instructions.

Updating Multiple Specific Lines in a Data Set

```
"ALLOC DA('dept5.employee.list') F(updatedd) OLD"
"EXECIO 1 DISKRU updatedd 2 (LIFO"
PULL line
PUSH 'Crandall, Amy          AMY          5500'
"EXECIO 1 DISKW updatedd"
"EXECIO 1 DISKRU updatedd 5 (LIFO"
PULL line
PUSH 'Leone, Mary           MARYL          5530'
"EXECIO 1 DISKW updatedd (FINIS"
"FREE F(updatedd)"
```

When you issue multiple EXECIO commands to the same data set before closing it and do not specify a line number, the most current EXECIO command begins reading where the previous one left off. Thus to scan a data set one line at a time and allow a user at a terminal to update each line, you might write the following exec.

Example of Scanning Each Line for Update

```
/****** REXX *****/
/* This exec scans a data set whose name and size are specified by */
/* a user. The user is given the option of changing each line as */
/* it appears. If there is no change to the line, the user presses*/
/* Enter key to indicate that there is no change. If there is a */
/* change to the line, the user types the entire line with the */
/* change and the new line is returned to the data set.          */
/*******/

PARSE ARG name numlines /* Get data set name and size from user */

"ALLOC DA("name") F(updatedd) OLD"
eof = 'NO' /* Initialize end-of-file flag */

DO i = 1 to numlines WHILE eof = 'NO'
"EXECIO 1 DISKRU updatedd" /* Queue the next line on the stack */
IF RC = 2 THEN /* Return code indicates end-of-file */
eof = 'YES'
ELSE
DO
PARSE PULL line
SAY 'Please make changes to the following line.'
SAY 'If you have no changes, press ENTER.'
SAY line
PARSE PULL newline
IF newline = '' THEN NOP
ELSE
DO
PUSH newline
"EXECIO 1 DISKW updatedd"
END
END
END
END
```

Additional Examples

Using EXECIO to Process Information ...

EXECIO Example 1

```
/****** REXX *****/
/* This exec reads from the data set allocated to INDD to find the */
/* first occurrence of the string "Jones". Upper and lowercase */
/* distinctions are ignored. */
/*******/
done = 'no'
lineno = 0

DO WHILE done = 'no'
  "EXECIO 1 DISKR indd"

  IF RC = 0 THEN /* Record was read */
    DO
      PULL record
      lineno = lineno + 1 /* Count the record */
      IF INDEX(record,'JONES') \= 0 THEN
        DO
          SAY 'Found in record' lineno
          done = 'yes'
          SAY 'Record = ' record
        END
      ELSE NOP
    END
  ELSE
    done = 'yes'
END

EXIT 0
```

Figure 1. EXECIO Example 1

EXECIO Example 2

```
/****** REXX *****/
/* This exec copies records from data set 'my.input' to the end of */
/* data set 'my.output'. Neither data set has been allocated to a */
/* ddname. It assumes that the input data set has no null lines. */
/*******/
"ALLOC DA('my.input') F(indd) SHR REUSE"
"ALLOC DA('my.output') F(outdd) MOD REUSE"

SAY 'Copying ...'

"EXECIO * DISKR indd (FINIS"
QUEUE '' /* Insert a null line at the end to indicate end of file */
"EXECIO * DISKW outdd (FINIS"

SAY 'Copy complete.'
"FREE F(indd outdd)"

EXIT 0
```

Figure 2. EXECIO Example 2

EXECIO Example 3

```

/***** REXX *****/
/* This exec reads five records from the data set allocated to */
/* MYINDD starting with the third record. It strips trailing blanks*/
/* from the records, and then writes any record that is longer than*/
/* 20 characters. The file is not closed when the exec is finished.*/
/*****
"EXECIO 5 DISKR myndd 3"

DO i = 1 to 5
  PARSE PULL line
  stripline = STRIP(line,t)
  len = LENGTH(stripline)

  IF len > 20 THEN
    SAY 'Line' stripline 'is long.'
  ELSE NOP
END

/* The file is still open for processing */

EXIT 0

```

Figure 3. EXECIO Example 3

EXECIO Example 4

```

/***** REXX *****/
/* This exec reads first 100 records (or until EOF) of the data */
/* set allocated to INVENTORY. Records are placed on data stack */
/* in LIFO order. If fewer than 100 records are read, a message is */
/* issued. */
/*****
eofflag = 2 /* Return code to indicate end of file */

"EXECIO 100 DISKR invntory (LIFO"
return_code = RC

IF return_code = eofflag THEN
  SAY 'Premature end of file.'
ELSE
  SAY '100 Records read.'

EXIT return_code

```

Figure 4. EXECIO Example 4

EXECIO Example 5

```

/***** REXX *****/
/* This exec illustrates the use of "EXECIO 0 ..." to open, empty, */
/* or close a file. It reads records from file indd, allocated */
/* to 'sams.input.dataset', and writes selected records to file */
/* outdd, allocated to 'sams.output.dataset'. In this example, the */
/* data set 'sams.input.dataset' contains variable-length records */
/* (RECFM = VB). */
/*****/
"FREE FI(outdd)"
"FREE FI(indd)"
"ALLOC FI(outdd) DA('sams.output.dataset') OLD REUSE"
"ALLOC FI(indd) DA('sams.input.dataset') SHR REUSE"
eofflag = 2 /* Return code to indicate end-of-file */
return_code = 0 /* Initialize return code */
in_ctr = 0 /* Initialize # of lines read */
out_ctr = 0 /* Initialize # of lines written */

/*****/
/* Open the indd file, but do not read any records yet. All */
/* records will be read and processed within the loop body. */
/*****/

"EXECIO 0 DISKR indd (OPEN" /* Open indd */

/*****/
/* Now read all lines from indd, starting at line 1, and copy */
/* selected lines to outdd. */
/*****/

DO WHILE (return_code ^= eofflag) /* Loop while not end-of-file */
  'EXECIO 1 DISKR indd' /* Read 1 line to the data stack */
  return_code = rc /* Save execio rc */
  IF return_code = 0 THEN /* Get a line ok? */
    DO /* Yes */
      in_ctr = in_ctr + 1 /* Increment input line ctr */
      PARSE PULL line.1 /* Pull line just read from stack*/
      IF LENGTH(line.1) > 10 then /* If line linger than 10 chars */
        DO
          "EXECIO 1 DISKW outdd (STEM line." /* Write it to outdd */
          out_ctr = out_ctr + 1 /* Increment output line ctr */
        END
      END
    END
  END "EXECIO 0 DISKR indd (FINIS" /* Close the input file, indd */

IF out_ctr > 0 THEN /* Were any lines written to outdd?*/
  DO /* Yes. So outdd is now open */

```

Figure 5. EXECIO Example 5

EXECIO Example 5 (continued)

```

/*****
/* Since the outdd file is already open at this point, the */
/* following "EXECIO 0 DISKW ..." command will close the file, */
/* but will not empty it of the lines that have already been */
/* written. The data set allocated to outdd will contain out_ctr*/
/* lines. */
/*****

"EXECIO 0 DISKW outdd (FINIS" /* Closes the open file, outdd */
SAY 'File outdd now contains ' out_ctr' lines.'
END
ELSE /* Else no new lines have been */
/* written to file outdd */
DO /* Erase any old records from the file*/

/*****
/* Since the outdd file is still closed at this point, the */
/* following "EXECIO 0 DISKW ..." command will open the file, */
/* write 0 records, and then close it. This will effectively */
/* empty the data set allocated to outdd. Any old records that */
/* were in this data set when this exec started will now be */
/* deleted. */
/*****

"EXECIO 0 DISKW outdd (OPEN FINIS" /*Empty the outdd file */
SAY 'File outdd is now empty.'
END
"FREE FI(indd)"
"FREE FI(outdd)"
EXIT

```

Figure 6. EXECIO Example 5 (continued)

Using EXECIO to Process Information ...

EXECIO Example 6

```
***** REXX *****
/* This exec uses EXECIO to successively append the records from */
/* 'sample1.data' and then from 'sample2.data' to the end of the */
/* data set 'all.sample.data'. It illustrates the effect of */
/* residual data in STEM variables. Data set 'sample1.data' */
/* contains 20 records. Data set 'sample2.data' contains 10 */
/* records. */
*****

"ALLOC FI(myindd1) DA('sample1.data') SHR REUSE" /* input file 1 */
"ALLOC FI(myindd2) DA('sample2.data') SHR REUSE" /* input file 2 */

"ALLOC FI(myoutdd) DA('all.sample.data') MOD REUSE" /* output append
file */

*****
/* Read all records from 'sample1.data' and append them to the */
/* end of 'all.sample.data'. */
*****

exec_RC = 0 /* Initialize exec return code */

"EXECIO * DISKR myindd1 (STEM newvar. FINIS" /* Read all records */

IF rc = 0 THEN /* If read was successful */
DO
  *****
  /* At this point, newvar.0 should be 20, indicating 20 records */
  /* have been read. Stem variables newvar.1, newvar.2, ... through */
  /* newvar.20 will contain the 20 records that were read. */
  *****

  SAY "-----"
  SAY newvar.0 "records have been read from 'sample1.data': "
  SAY
  DO i = 1 TO newvar.0 /* Loop through all records */
    SAY newvar.i /* Display the ith record */
  END

  "EXECIO" newvar.0 "DISKW myoutdd (STEM newvar." /* Write exactly
the number of records read */
```

Figure 7. EXECIO Example 6

EXECIO Example 6 (continued)

```

IF rc = 0 THEN          /* If write was successful */
DO
  SAY
  SAY newvar.0 "records were written to 'all.sample.data'"
END
ELSE
DO
  exec_RC = RC          /* Save exec return code */
  SAY
  SAY "Error during 1st EXECIO ... DISKW, return code is " RC
  SAY
END
END
ELSE
DO
  exec_RC = RC          /* Save exec return code */
  SAY
  SAY "Error during 1st EXECIO ... DISKR, return code is " RC
  SAY
END
END

IF exec_RC = 0 THEN    /* If no errors so far... continue */
DO
  /******
  /* At this time, the stem variables newvar.0 through newvar.20 */
  /* will contain residual data from the previous EXECIO. We */
  /* issue the "DROP newvar." instruction to clear these residual*/
  /* values from the stem. */
  /******
  DROP newvar.          /* Set all stem variables to their
                        uninitialized state */
  /******
  /* Read all records from 'sample2.data' and append them to the */
  /* end of 'all.sample.data'. */
  /******
  "EXECIO * DISKR myindd2 (STEM newvar. FINIS" /*Read all records*/
  IF rc = 0 THEN      /* If read was successful */
  DO
  /******
  /* At this point, newvar.0 should be 10, indicating 10 */
  /* records have been read. Stem variables newvar.1, newvar.2,*/
  /* ... through newvar.10 will contain the 10 records. If we */
  /* had not cleared the stem newvar. with the previous DROP */
  /* instruction, variables newvar.11 through newvar.20 would */
  /* still contain records 11 through 20 from the first data */
  /* set. However, we would know that these values were not */
  /* read by the last EXECIO DISKR since the current newvar.0 */
  /* variable indicates that only 10 records were read by */
  /* that last EXECIO. */
  /******
  
```

Figure 8. EXECIO Example 6 (continued)

:

Using EXECIO to Process Information ...

EXECIO Example 6 (continued)

```
SAY
SAY
SAY "-----"
SAY newvar.0 "records have been read from 'sample2.data': "
SAY
DO i = 1 TO newvar.0 /* Loop through all records */
  SAY newvar.i /* Display the ith record */
END

"EXECIO" newvar.0 "DISKW myoutdd (STEM newvar." /* Write
                                                    exactly the number of records read */
IF rc = 0 THEN /* If write was successful */
  DO
    SAY
    SAY newvar.0 "records were written to 'all.sample.data'"
  END
ELSE
  DO
    exec_RC = RC /* Save exec return code */
    SAY
    SAY "Error during 2nd EXECIO ...DISKW, return code is " RC
    SAY
  END
END
ELSE
  DO
    exec_RC = RC /* Save exec return code */
    SAY
    SAY "Error during 2nd EXECIO ... DISKR, return code is " RC
    SAY
  END
END
END

"EXECIO 0 DISKW myoutdd (FINIS" /* Close output file */

"FREE FI(myindd1)"
"FREE FI(myindd2)"
"FREE FI(myoutdd)"
EXIT 0
```

Figure 9. EXECIO Example 6 (continued)

Chapter 13. Using REXX in TSO/E and Other MVS Address Spaces

Services Available to REXX Execs	171
Running Execs in a TSO/E Address Space	173
Running an Exec in the Foreground.	173
Things to Consider When Allocating to a System File (SYSPROC or SYSEXEC)	174
Allocating to SYSEXEC	174
Allocating to SYSPROC	174
Running an Exec from a CLIST	175
Running an Exec in the Background	176
Running Execs in a Non-TSO/E Address Space	177
Using an Exec Processing Routine to Invoke an Exec from a Program	177
Using IRXJCL to Run an Exec in MVS Batch	178
Using the Data Stack in TSO/E Background and MVS Batch	180
Summary of TSO/E Background and MVS Batch	180
CAPABILITIES	180
REQUIREMENTS	181
Defining Language Processor Environments	181
What is a Language Processor Environment?	181
Customizing a Language Processor Environment.	182

This chapter describes how to use REXX in TSO/E and in non-TSO/E address spaces in MVS. It also briefly describes the concept of a language processor environment.

Services Available to REXX Execs

This book, until now, has described writing and running REXX execs in the TSO/E address space. Besides TSO/E, execs can run in other address spaces within MVS. Where an exec can run is determined by the types of services the exec requires. There are services that are available to an exec that runs in any address space, TSO/E or non-TSO/E; and there are more specific services available only in a TSO/E address space. The following table lists all the services and where they are available.

Service	Non-TSO/E Address Space	TSO/E Address Space
REXX language instructions — These instructions are used throughout this book. For a description of each one, see <i>z/OS TSO/E REXX Reference</i> .	X	X
Built-in functions — A brief description of each built-in function appears in “Built-In Functions” on page 63. A longer description appears in <i>z/OS TSO/E REXX Reference</i> .	X	X
TSO/E REXX commands — These commands consist of: <ul style="list-style-type: none"> Data stack commands — For more information, see “Chapter 11. Storing Information in the Data Stack” on page 135. 		
DELSTACK	X	X
DROPBUF	X	X
MAKEBUF	X	X
NEWSTACK	X	X

Services Available to REXX Execs

Service	Non-TSO/E Address Space	TSO/E Address Space
QBUF	X	X
QELEM	X	X
QSTACK	X	X
• Other commands —		
EXECIO — controls I/O processing	X	X
EXECUTIL — changes how an exec runs		X
Immediate commands:		
HI (from attention mode only)		X
HE (from attention mode only)		X
HT (from attention mode only)		X
RT (from attention mode only)		X
TE	X	X
TS	X	X
SUBCOM — queries the existence of a host command environment	X	X
TSO/E commands — All TSO/E commands, both authorized and unauthorized can be issued from an exec that runs in a TSO/E address space. For a description of these commands, see <i>z/OS TSO/E Command Reference</i> .		X
TSO/E External Functions:		
• GETMSG — retrieves system messages issued during an extended MCS console session		X
• LISTDSI — returns data set attributes		X
• MSG — controls the display of messages for TSO/E commands		X
• MVSVAR — returns information about MVS, TSO/E and the current session	X	X
• OUTTRAP — traps lines of TSO/E command output		X
• PROMPT — controls prompting for TSO/E interactive commands		X

Services Available to REXX Execs

Service	Non-TSO/E Address Space	TSO/E Address Space
• SETLANG — controls the language in which REXX messages are displayed	X	X
• STORAGE — retrieves and optionally changes the value in a storage address	X	X
• SYSCPUS — returns information about CPUs that are online	X	X
• SYSDSN — returns information about the availability of a data set		X
• SYSVAR — returns information about the user, the terminal, the exec, and the system		X
Interaction with CLISTs — Execs and CLISTs can call each other and pass information back and forth. For more information, see “Running an Exec from a CLIST” on page 175.		X
ISPF and ISPF/PDF services — An exec that is invoked from ISPF can use that dialog manager’s services.		X

Running Execs in a TSO/E Address Space

Earlier sections in this book described how to run an exec in TSO/E explicitly and implicitly in the **foreground**. When you run an exec in the foreground, you do not have use of your terminal until the exec completes. Another way to run an exec is in the **background**, which allows you full use of your terminal while the exec runs.

Running an Exec in the Foreground

Interactive execs and ones written that involve user applications are generally run in the foreground. You can invoke an exec in the foreground in the following ways:

- Explicitly with the EXEC command. For more information, see “Running an Exec Explicitly” on page 16.
- Implicitly by member name if the PDS containing the exec was previously allocated to SYSPROC or SYSEXEC. (Your installation might have a different name for the system file that contains execs. For the purposes of this book, it is called SYSEXEC.) For more information, see “Running an Exec Implicitly” on page 17 and “Appendix A. Allocating Data Sets” on page 185.
- From another exec as an external function or subroutine, as long as both execs are in the same PDS or the PDSs containing the execs are allocated to a system file, for example SYSPROC or SYSEXEC. For more information about external functions and subroutines, see “Chapter 6. Writing Subroutines and Functions” on page 69.
- From a CLIST or other program. For more information, see “Running an Exec from a CLIST” on page 175.

Running Execs in a TSO/E Address Space

Things to Consider When Allocating to a System File (SYSPROC or SYSEXEC)

Allocating a partitioned data set containing execs to a system file allows you to:

- Run execs implicitly - After a PDS is allocated to a system file, you can run the exec by simply entering the member name, which requires fewer keystrokes and is therefore faster to invoke.
- Invoke user-written external functions and subroutines written in REXX that are in PDSs also allocated to SYSEXEC or SYSPROC.
- Control search order - You can concatenate the data sets within the file to control search order. This is useful in testing a version of an exec placed earlier in the search order than the original version.
- Compression - In certain situations a REXX exec will be compressed to optimize usage of system storage. These situations can arise only when the exec is stored in either SYSPROC or the application-level CLIST file using the ALTLIB command. The compression removes comment text between the comment delimiters /* and */, removes leading and trailing blanks, and replaces blank lines with null lines. Blanks and comments within literal strings or DBCS strings are not removed. If the system finds the characters "SOURCELINE" outside of a comment, the exec is not compressed. Additionally, if you do not want an exec to be compressed, you can allocate the exec to the CLIST user-level file, or any of the levels used for execs.
- Improve performance - Depending on your installation's setup, you can affect the performance of execs you run by allocating the data sets that contain them to either SYSEXEC or SYSPROC. More about this technique appears in the following sections on allocating to a specific system file.

Allocating to SYSEXEC

SYSEXEC is a system file that can contain execs only. SYSEXEC precedes SYSPROC in the search order. Therefore execs in PDSs allocated to SYSEXEC are retrieved more rapidly than execs in PDSs allocated to SYSPROC.

Allocating to SYSPROC

SYSPROC is a system file that originally contained only CLISTs written for applications or for an individual's use. SYSPROC now can also contain execs as long as the execs are distinguishable from CLISTs.

The SYSEXEC file is searched first, followed by SYSPROC. If your installation uses a large number of CLISTs that are in data sets allocated to SYSPROC and you do not have a large number of REXX execs, you may want to use SYSPROC only and not use SYSEXEC. To use SYSPROC only, a system programmer can change the search order on an installation-wide basis, or an individual can change the search order using the EXECUTIL SEARCHDD(NO) command. You can issue the EXECUTIL SEARCHDD(NO) command directly from the terminal, from an exec or CLIST, and from the JCL input stream run in TSO/E background. The ALTLIB command can also affect search order. For general information about ALTLIB, see "Appendix B. Specifying Alternate Libraries with the ALTLIB Command" on page 195. For more information about the EXECUTIL and ALTLIB commands, see *z/OS TSO/E Command Reference*.

Running an Exec from a CLIST

A CLIST can invoke an exec with the EXEC command explicitly or implicitly. If it invokes an exec implicitly, the exec must be in a PDS allocated to SYSEXEC or SYSPROC. The CLIST that invokes the exec does not have to be allocated to SYSPROC. After the invoked exec and other programs it might call complete, control returns to the CLIST instruction following the invocation.

Similarly, an exec can invoke a CLIST with the EXEC command explicitly or implicitly. If it invokes a CLIST implicitly, the CLIST must be in a PDS allocated to SYSPROC, yet the exec does not have to be in a PDS allocated to a system file.

Note: Execs and CLISTs cannot access each other's variables and GLOBAL variables cannot be declared in a CLIST that is invoked from an exec.

The following examples demonstrate how a CLIST invokes an exec and how a number is returned to the invoking CLIST. The CLIST named TEST explicitly executes an exec named EXEC1. EXEC1 calls EXEC2, which returns the result "A OK". EXEC1 then returns to the CLIST with a numeric return code of 100 if information was passed correctly and 50 if information was not passed correctly.

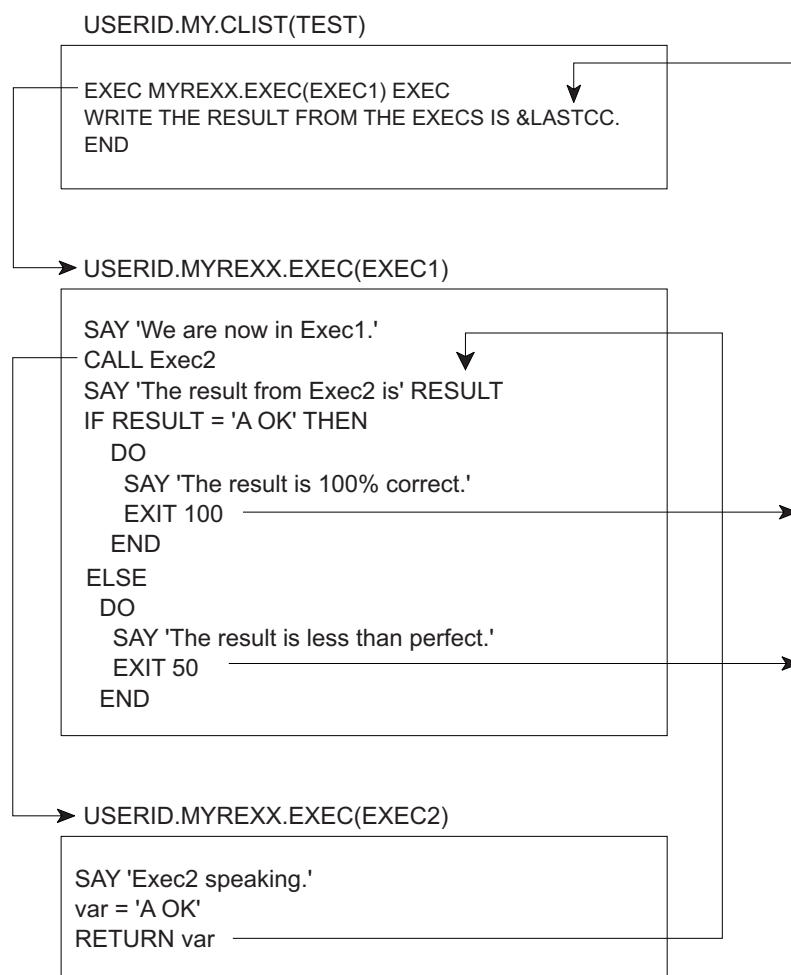

The results from this series of programs is as follows:

Running Execs in a TSO/E Address Space

```
We are now in Exec1.  
Exec2 speaking.  
The result from Exec2 is A OK  
The result is 100% correct.  
THE RESULT FROM THE EXECs IS 100
```

Sending a Return Code Back to the Calling CLIST: As demonstrated in the previous example, an exec can return a number to a CLIST with the EXIT instruction followed by the number or a variable representing the number. The CLIST receives the number in the variable &LASTCC.

When an exec invokes a CLIST, the CLIST can return a number to the exec by the EXIT CODE() statement with the number to be returned enclosed in parentheses after CODE. The exec receives the number in the REXX special variable RC.

Note: &LASTCC is set after each CLIST statement or command executes as compared to RC, which is set after each command executes. To save the values of each special variable, set a new variable with the value at the point where you want the special variable value saved.

In the following two examples, exec USERID.MYREXX.EXEC(TRANSFER) passes an argument to CLIST USERID.MY.CLIST(RECEIVE), and the CLIST returns a number through the CODE parameter of the EXIT statement.

USERID.MYREXX.EXEC(TRANSFER)

```
/****** REXX *****/  
/* This exec passes a percent sign to a CLIST and depending on */  
/* the success of the transfer, the CLIST returns 100 (if it was */  
/* successful) or 50 (if it was not successful). */  
/*******/  
  
SAY 'We are about to execute CLIST RECEIVE and pass it % '  
  
"EXEC my.clist(receive) '% ' clist"  
  
SAY 'We have returned from the CLIST.'  
IF RC = 100 THEN  
  SAY 'The transfer was a success.'  
ELSE  
  SAY 'The transfer was not a success.'
```

USERID.MY.CLIST(RECEIVE)

```
PROC 1 &VAR  
IF &VAR = % THEN SET SUCCESS = 100  
ELSE SET SUCCESS = 50  
EXIT CODE(&SUCCESS)
```

Running an Exec in the Background

Execs run in the background are processed when higher priority programs are not using the system. Background processing does not interfere with a person's use of the terminal. You can run time-consuming and low priority execs in the background, or execs that do not require terminal interaction.

Running Execs in a TSO/E Address Space

Running an exec in the background is the same as running a CLIST in the background. The program IKJEFT01 sets up a TSO/E environment from which you can invoke execs and CLISTs and issue TSO/E commands. For example, to run an exec named SETUP contained in a partitioned data set USERID.MYREXX.EXEC, submit the following JCL.

Example of JCL to Run an Exec in the Background

```
//USERIDA JOB 'ACCOUNT,DEPT,BLDG','PROGRAMMER NAME',
// CLASS=J,MSGCLASS=C,MSGLEVEL=(1,1)
//*
//TMP EXEC PGM=IKJEFT01,DYNAMNBR=30,REGION=4096K
//SYSEXEC DD DSN=USERID.MYREXX.EXEC,DISP=SHR
//SYSTSPRT DD SYSOUT=A
//SYSTSIN DD *
%SETUP
/*
//
```

The EXEC statement defines the program as IKJEFT01. In a DD statement, you can assign one or more PDSs to the SYSEXEC or SYSPROC system file. The SYSTSPRT DD allows you to print output to a specified data set or a SYSOUT class. In the input stream, after the SYSTSIN DD, you can issue TSO/E commands and invoke execs and CLISTs.

The preceding example must be written in a fixed block, 80 byte record data set. To start the background job, issue the SUBMIT command followed by the data set name, for example, REXX.JCL.

```
SUBMIT rexx.jcl
```

For more information about running jobs in the background, see *z/OS TSO/E User's Guide*.

Running Execs in a Non-TSO/E Address Space

Because execs that run in a non-TSO/E address space cannot be invoked by the TSO/E EXEC command, you must use other means to run them. Ways to run execs outside of TSO/E are:

- From a high level program using the IRXEXEC or IRXJCL processing routines.
- From MVS batch with JCL that specifies IRXJCL in the EXEC statement.

TSO/E provides the TSO/E environment service, IKJTSOEV. Using IKJTSOEV, you can create a TSO/E environment in a non-TSO/E address space. You can then run REXX execs in the environment and the execs can contain TSO/E commands, external functions, and services that an exec running in a TSO/E address space can use. For information about the TSO/E environment service and how to run REXX execs within the environment, see *z/OS TSO/E Programming Services*.

Using an Exec Processing Routine to Invoke an Exec from a Program

To invoke an exec from a high-level language program running in an MVS address space, use one of the exec processing routines (IRXEXEC or IRXJCL). If you use IRXEXEC, you must specify parameters that define the exec to be run and supply other related information. For more information, see *z/OS TSO/E REXX Reference*.

Running Execs in a Non-TSO/E Address Space

You can also use an exec processing routine to invoke an exec in a TSO/E address space. Two reasons to use them in TSO/E are:

- To pass more than one argument to an exec. When invoking an exec implicitly or explicitly, you can pass only one argument string. With IRXEXEC, you can pass multiple arguments.
- To call an exec from a program other than a CLIST or exec.

Using IRXJCL to Run an Exec in MVS Batch

To run a REXX exec in MVS batch, you must specify program IRXJCL in the JCL EXEC statement. SYSEXEC is the default load DD. Running an exec in MVS batch is similar in many ways to running an exec in the TSO/E background, however, there are significant differences. One major difference is that the exec running in MVS batch cannot use TSO/E services, such as TSO/E commands and most of the TSO/E external functions. Additional similarities and differences appear in “Summary of TSO/E Background and MVS Batch” on page 180.

The following series of examples show how an MVS batch job named USERIDA invokes a REXX exec in a PDS member named USERID.MYREXX.EXEC(JCLTEST). The member name, JCLTEST, is specified as the first word after the PARM parameter of the EXEC statement. Two arguments, TEST and IRXJCL, follow the member name. Output from the exec goes to an output data set named USERID.IRXJCL.OUTPUT, which is specified in the SYSTSPRT DD statement. The SYSTSIN DD statement supplies the exec with three lines of data in the input stream. This exec also uses EXECIO to write a 1-line timestamp to the end of the sequential data set USERID.TRACE.OUTPUT, which is allocated in the OUTDD statement.

USERID.JCL.EXEC

```
//USERIDA JOB 'ACCOUNT,DEPT,BLDG','PROGRAMMER NAME',
// CLASS=J,MSGCLASS=H,MSGLEVEL=(1,1)
//*
//MVSBACK EXEC PGM=IRXJCL,
//          PARM='JCLTEST Test IRXJCL'
//*
//* Name of exec      <-----> |
//* Argument         <-----> |
//OUTDD  DD  DSN=USERID.TRACE.OUTPUT,DISP=MOD
//SYSTSPRT DD DSN=USERID.IRXJCL.OUTPUT,DISP=OLD
//SYSEXEC DD DSN=USERID.MYREXX.EXEC,DISP=SHR
//SYSTSIN DD *
First line of data
Second line of data
Third line of data
/*
//
```

Running Execs in a Non-TSO/E Address Space

USERID.MYREXX.EXEC(JCLTEST)

```
/****** REXX ******/
/* This exec receives input from its invocation in JCL.EXEC, pulls*/
/* data from the input stream and sends back a condition code of */
/* 137. */
/*******/
TRACE error
SAY 'Running exec JCLTEST'
ADDRESS MVS
PARSE ARG input
SAY input
DATA = start

DO UNTIL DATA = '
  PARSE PULL data          /* pull data from the input stream */
  SAY data
END

/*******/
/* Now use EXECIO to write a timestamp to the sequential */
/* data set that was allocated to the OUTDD file by the JCL */
/* used to invoke this exec. */
/*******/
OUTLINE.1 = 'Exec JCLTEST has ended at' TIME()
"EXECIO 1 DISKW OUTDD (STEM OUTLINE. FINIS"    /* Write the line */

SAY 'Leaving exec JCLTEST'
EXIT 137          /* send a condition code of 137 */
```

USERID.TRACE.OUTPUT

Exec JCLTEST has ended at 15:03:06

USERID.IRXJCL.OUTPUT

```
Running exec JCLTEST
Test IRXJCL
  First line of data
  Second line of data
  Third line of data

Leaving exec JCLTEST
```

Running Execs in a Non-TSO/E Address Space

Segment of Output from the JCL Listing

```

ALLOC. FOR USERIDA MVSBACK
224 ALLOCATED TO OUTDD
954 ALLOCATED TO SYSTSPRT
7E0 ALLOCATED TO SYSEXEC
JES2 ALLOCATED TO SYSTSIN
USERIDA MVSBACK - STEP WAS EXECUTED - COND CODE 0137
USERID.TRACE.OUTPUT KEPT
VOL SER NOS= TS0032.
USERID.IRXJCL.OUTPUT KEPT
VOL SER NOS= TS0032.
USERID.MYREXX.EXEC KEPT
VOL SER NOS= TS0001.
JES2.JOB28359.I0000101 SYSIN
STEP / MVSBACK / START 88167.0826
STEP / MVSBACK / STOP 88167.0826 CPU 0MIN 00.16SEC SRB ...
JOB / USERIDA / START 88167.0826
JOB / USERIDA / STOP 88167.0826 CPU 0MIN 00.16SEC SRB ...

```

Using the Data Stack in TSO/E Background and MVS Batch

When an exec runs in the TSO/E background or MVS batch, it has the same use of the data stack as an exec that runs in the TSO/E foreground. The PULL instruction, however, works differently when the data stack is empty. In the TSO/E foreground, PULL goes to the terminal for input. In the TSO/E background and MVS batch, PULL goes to the input stream as defined by ddname SYSTSIN. When SYSTSIN has no data, the PULL instruction returns a null. If the input stream has no data and the PULL instruction is in a loop, the exec can result in an infinite loop.

Summary of TSO/E Background and MVS Batch

CAPABILITIES

TSO/E BACKGROUND (IKJEFT01)	MVS BATCH (IRXJCL)
Execs run without terminal interaction.	Execs run without terminal interaction.
Execs can contain: <ul style="list-style-type: none"> • REXX instructions • Built-in functions • TSO/E REXX commands • TSO/E commands • TSO/E external functions 	Execs can contain: <ul style="list-style-type: none"> • REXX instructions • Built-in functions • TSO/E REXX commands • The TSO/E external functions, STORAGE and SETLANG
Execs are invoked through the PARM parameter on the EXEC statement and through explicit or implicit use of the EXEC command in the input stream.	Execs are invoked through the PARM parameter on the EXEC statement. The first word on the PARM parameter is the member name of the PDS to be invoked. Following words are arguments to be passed.
Information in the input stream is processed as TSO/E commands and invocations of execs and CLISTS.	Information in the input stream is processed as input data for the exec that is running.
Output sent to a specified output data set or to a SYSOUT class.	Output sent to a specified output data set or to a SYSOUT class.

Summary of TSO/E Background and MVS Batch

TSO/E BACKGROUND (IKJEFT01)	MVS BATCH (IRXJCL)
Messages are displayed in the output file.	Messages may appear in two places; the JCL output listing and in the output file. To suppress messages in the output file, use the TRACE OFF instruction.

REQUIREMENTS

TSO/E BACKGROUND (IKJEFT01)	MVS BATCH (IRXJCL)
The default DDs are SYSTSPRT and SYSTSIN.	The default DDs are SYSTSPRT and SYSTSIN.
Initiated by executing program IKJEFT01.	Initiated by executing program IRXJCL.
JCL should be written in a fixed block, 80-byte record data set.	JCL should be written in a fixed block, 80-byte record data set.
Exec that is invoked can be either a member of a PDS or a sequential data set.	Exec that is invoked must be a member of a PDS.
Data set may be allocated to either SYSEXEC or SYSPROC.	Data set must be allocated to the SYSEXEC DD.

Defining Language Processor Environments

Before an exec can be processed, a language processor environment must exist. A language processor environment defines the way a REXX exec is processed and how it accesses system services. Because MVS contains different types of address spaces and each one accesses services a different way, REXX in TSO/E provides three default parameters modules that define language processor environments.

They are:

- IRXTSPRM - for TSO/E
- IRXPARMs - for non-TSO/E
- IRXISPRM - for ISPF

The defaults are set by TSO/E but they can be modified by a system programmer.

What is a Language Processor Environment?

A language processor environment defines characteristics, such as:

- The search order used to locate commands and external routines
- The ddnames for reading and writing data and from which execs are loaded
- The valid host command environments and the routines that process commands in each host command environment
- The function packages (user, local, and system) that are available in the environment and the entries in each package
- Whether execs running in the environment can use the data stack
- The names of routines that handle system services, such as I/O operations, loading of an exec, obtaining and freeing storage, and data stack requests

Note: A language processor environment is different from a host command environment. The language processor environment is the environment in which a REXX exec runs. The host command environment is the environment to which the language processor passes commands for execution. The valid host command environments are defined by the language processor environment.

Defining Language Processor Environments

For more information about defining language processor environments, see *z/OS TSO/E REXX Reference*.

Customizing a Language Processor Environment

An individual or an installation can customize a language processor environment in two ways:

- Change the values in the three default parameters modules, IRXTSPRM, IRXISPRM, and IRXPARMs.
- Call an initialization routine IRXINIT and specifying parameters to change default parameters.

For more information about customizing a language processor environment, see *z/OS TSO/E REXX Reference*.

Part 3. Appendixes

Appendix A. Allocating Data Sets

What is Allocation?	185
Where to Begin	186
Preliminary Checklist	186
Checklist #1: Creating and Editing a Data Set Using ISPF/PDF	187
Checklist #2: Creating a Data Set with the ALLOCATE Command.	190
Checklist #3: Writing an Exec that Sets up Allocation to SYSEXEC	191
Checklist #4: Writing an Exec that Sets up Allocation to SYSPROC	192

Execs can be stored in either sequential data sets or partitioned data sets (PDSs). A sequential data set contains only one exec, while a PDS can contain one or more execs. In a PDS, each exec is a member and has a unique member name. When a PDS consists entirely of execs, it is called an exec library.

Exec libraries make execs easy to maintain and execute. Your installation can keep commonly used execs in a system library and you can keep your own execs in a private exec library. To learn important information about data sets at your installation, use the “Preliminary Checklist” on page 186.

What is Allocation?

Before you can store execs in a data set, you must create the data set by allocation. Allocation can mean different things depending on your purpose. In this book allocation means two things:

- **Creating a new data set** in which to store REXX execs. You can create a new data set with the ISPF/PDF UTILITIES option or with the TSO/E ALLOCATE command.
Checklists for creating a data set appear in:
 - “Checklist #1: Creating and Editing a Data Set Using ISPF/PDF” on page 187
 - “Checklist #2: Creating a Data Set with the ALLOCATE Command” on page 190
- **Accessing an existing data set** and associating it, and possibly other data sets, to a system file. Allocating a data set to a system file (SYSEXEC or SYSPROC) enables you to execute the execs **implicitly** by simply typing their member names. When more than one PDS is specified in the allocation, they are **concatenated** or logically connected in the order in which they are specified. The association of the PDS to the system file remains for the duration of your terminal session or until another ALLOCATE command alters the association. You can allocate a data set to a system file in the foreground with the TSO/E ALLOCATE command or in the background with a JCL DD statement. You *cannot* use ISPF/PDF to allocate a data set to a system file.
Checklists for allocating a data set to SYSEXEC and SYSPROC appear in:
 - “Checklist #3: Writing an Exec that Sets up Allocation to SYSEXEC” on page 191
 - “Checklist #4: Writing an Exec that Sets up Allocation to SYSPROC” on page 192

Where to Begin

Before creating a PDS in which to store your execs, use the “Preliminary Checklist” to find out information that you can use to make your PDS compatible with other PDSs at your installation. Then create a PDS with either “Checklist #1: Creating and Editing a Data Set Using ISPF/PDF” on page 187 or “Checklist #2: Creating a Data Set with the ALLOCATE Command” on page 190.

After the PDS is created, if you want to be able to invoke those execs implicitly during that terminal session, you must allocate the PDS to a system file (SYSEXEC or SYSPROC). The allocation is temporary and must be established for each terminal session. One way to establish the allocation is to write a setup exec that automatically executes when you log on. Information about how to write a setup exec is in Checklist #3 on page 191 and Checklist #4 on page 192. If you do not know which checklist to use, use Checklist #3.

The following checklists assume that the defaults shipped with TSO/E have not been altered by your installation. Also if your installation changes system allocations after you have used the checklists to set up your private allocation, you might need to use the checklists again to keep your allocations up-to-date.

Preliminary Checklist

1. **Issue the LISTALC STATUS command to see the names of all data sets allocated to SYSEXEC and SYSPROC.**

To see what data sets are already defined to SYSEXEC and SYSPROC at your installation, issue the LISTALC command with the STATUS keyword.

```
READY
listalc status
```

You then see several screens of data set names that might look something like the following. Scroll until you find SYSEXEC and SYSPROC.

```
--DDNAME---DISP--
ICQ.INFOCTR.LOAD.
  STEPLIB  KEEP
CATALOG.VTS0022
  SYS00006  KEEP,KEEP
CATALOG.VTS0028
  KEEP,KEEP
ISP.PHONE.EXEC
  SYSEXEC  KEEP
ICQ.INFOCTR.ICQCLIB
  SYSPROC  KEEP
SYS1.TSO.CLIST
  KEEP
ISP.ISPF.CLISTS
  KEEP
```

In this example, one data set ISP.PHONE.EXEC is allocated to SYSEXEC, and three data sets ICQ.INFOCTR.ICQCLIB, SYS1.TSO.CLIST, and ISP.ISPF.CLISTS are allocated to SYSPROC. (When a space appears below the data set name, the data set is allocated to the previously-specified file (DDNAME)).

2. **Write down the names of the data sets at your installation that are allocated to SYSEXEC.**

First data set: _____
Remaining data sets: _____

- _____
- _____
3. **Write down the names of the data sets at your installation that are allocated to SYSPROC.**

First data set: _____
 Remaining data sets: _____

4. **Issue the LISTDS command for the first data set in each system file to display the record format, logical record length, and block size.**

To see the attributes of data sets used at your installation, issue the LISTDS command for the first data set in each system file concatenation to display something like the following:

```
READY
LISTDS 'sysexec.first.exec'
```

```
SYSEXEC.FIRST.EXEC
--RECFM-LRECL-BLKSIZE-DSORG
  VB   255  5100   PO
--VOLUMES--
  TS0026
```

```
READY
LISTDS 'sysproc.first.clist'
```

```
SYSPROC.FIRST.CLIST
--RECFM-LRECL-BLKSIZE-DSORG
  FB    80  19040   PO
--VOLUMES--
  TS0L07
```

5. **Write down the attributes of the first data set in your SYSEXEC concatenation.**

RECFM = _____
 LRECL = _____
 BLKSIZE = _____

6. **Write down the attributes of the first data set in your SYSPROC concatenation.**

RECFM = _____
 LRECL = _____
 BLKSIZE = _____

Please Note

Save this information for use with the following checklists.

Checklist #1: Creating and Editing a Data Set Using ISPF/PDF

1. **Select the ISPF/PDF DATASET UTILITIES option (option 3.2).**
 From the ISPF/PDF Primary Option Menu, select the UTILITIES option (option 3) and press the Enter key.

Checklist #1

```
----- ISPF/PDF PRIMARY OPTION MENU -----
OPTION ==> 3
0 ISPF PARMS - Specify terminal and user parameters   USERID - YOURID
1 BROWSE     - Display source data or output listings  TIME    - 12:47
2 EDIT      - Create or change source data           TERMINAL - 3277
3 UTILITIES - Perform utility functions              PF KEYS - 12
4 FOREGROUND - Invoke language processors in foreground
5 BATCH     - Submit job for language processing
6 COMMAND   - Enter TSO command or CLIST
7 DIALOG TEST - Perform dialog testing
8 LM UTILITIES- Perform library administrator utility functions
9 IBM PRODUCTS- Additional IBM program development products
C CHANGES  - Display summary of changes for this release
T TUTORIAL  - Display information about ISPF/PDF
X EXIT      - Terminate ISPF using log and list defaults

Enter END command to terminate ISPF.
```

Then select the DATASET option (option 2) and press the Enter key.

```
----- UTILITY SELECTION MENU -----
OPTION ==> 2
1 LIBRARY - Compress or print data set. Print index listing.
           Print, rename, delete, or browse members
2 DATASET - Allocate, rename, delete, catalog, uncatalog, or
           display information of an entire data set
3 MOVE/COPY - Move, copy, or promote members or data sets
4 DSLIST   - Print or display (to process) list of data set names
           Print or display VTOC information
5 RESET    - Reset statistics for members of ISPF library
6 HARDCOPY - Initiate hardcopy output
8 OUTLIST  - Display, delete, or print held job output
9 COMMANDS - Create/change an application command table
10 CONVERT - Convert old format menus/messages to new format
11 FORMAT  - Format definition for formatted data Edit/Browse
12 SUPERC  - Compare data sets (Standard dialog)
13 SUPERCE - Compare data sets (Extended dialog)
14 SEARCH-FOR - Search data sets for strings of data
D DATA MGMT - Data Management Tools
```

2. **Specify a new data set name on the Data Set Utility panel and type A on the OPTION line.**

On the next panel that appears, type the name of the data set you want to allocate, for example USERID.REXX.EXEC, and enter A on the OPTION line.

```
----- DATA SET UTILITY -----
OPTION ==> a
A - Allocate new data set           C - Catalog data set
R - Rename entire data set          U - Uncatalog data set
D - Delete entire data set          S - Data set information (short)
blank - Data set information

ISPF LIBRARY:
PROJECT ==>  userid
GROUP   ==>  rexx
TYPE    ==>  exec

OTHER PARTITIONED OR SEQUENTIAL DATA SET:
DATA SET NAME ==>
VOLUME SERIAL ==>  left 0If not cataloged, required for option "C")

DATA SET PASSWORD ==>  (If password protected)
```

3. **Specify the data set attributes on the Allocate New Data Set panel.**

Checklist #1

After you name the data set, a panel appears on which you define the attributes of the data set. Use the attributes recommended by your installation for REXX libraries, and include the record format (RECFM), record length (LRECL), and block size (BLKSIZE) from the appropriate system file from the Preliminary Checklist #5 on page 187. If you are unsure about which system file is appropriate, use the values from SYSEXEC.

If your installation has no attribute recommendations and you have no attributes from the Preliminary Checklist, you can use the following attributes on the ISPF/PDF Allocate New Data Set panel:

```
----- ALLOCATE NEW DATA SET -----
COMMAND ==>

DATA SET NAME:  USERID.REXX.EXEC

VOLUME SERIAL   ==>          (Blank for authorized default volume)*
GENERIC UNIT    ==>          (Generic group name or unit address)*
SPACE UNITS     ==> blks    (BLKS, TRKS or CYLS)
PRIMARY QUAN    ==> 50      (in above units)
SECONDARY QUAN  ==> 20      (in above units)
DIRECTORY BLOCKS ==> 10      (Zero for sequential data set)
RECORD FORMAT   ==> VB
RECORD LENGTH   ==> 255
BLOCK SIZE      ==> 6120
EXPIRATION DATE ==>          (YY/MM/DD
                               YY.DDD in julian form
                               DDDD for retention period in days
                               or blank)

( * Only one of these fields may be specified)
```

4. Edit a member of the newly created PDS by selecting the EDIT option (option 2) and specifying the PDS name with a member name.

After you have allocated a PDS, you can press the RETURN PF key (PF4) to return to the Primary Option Menu and begin an edit session. Select the EDIT option (option 2) from the ISPF/PDF Primary Option Menu.

```
----- ISPF/PDF PRIMARY OPTION MENU -----
OPTION ==> 2

                                USERID - YOURID
0  ISPF PARMS - Specify terminal and user parameters    TIME - 12:47
1  BROWSE    - Display source data or output listings  TERMINAL - 3277
2  EDIT      - Create or change source data            PF KEYS - 12
3  UTILITIES - Perform utility functions
4  FOREGROUND - Invoke language processors in foreground
5  BATCH     - Submit job for language processing
6  COMMAND   - Enter TSO command or CLIST
7  DIALOG TEST - Perform dialog testing
8  LM UTILITIES- Perform library administrator utility functions
9  IBM PRODUCTS- Additional IBM program development products
C  CHANGES  - Display summary of changes for this release
T  TUTORIAL  - Display information about ISPF/PDF
X  EXIT      - Terminate ISPF using log and list defaults

Enter END command to terminate ISPF.
```

Then specify the data set name and member name on the Edit - Entry Panel. In the example that follows, the member name is **timegame**.

Checklist #1

```
----- EDIT - ENTRY PANEL -----
COMMAND ==>

ISPF LIBRARY:
  PROJECT ==> userid
  GROUP   ==> rexx      ==>          ==>          ==>
  TYPE    ==> exec
  MEMBER  ==> timegame  (Blank for member selection list)

OTHER PARTITIONED OR SEQUENTIAL DATA SET:
  DATA SET NAME ==>
  VOLUME SERIAL  ==>      (If not cataloged)

  DATA SET PASSWORD ==>      (If password protected)

  PROFILE NAME    ==>      (Blank defaults to data set type)

  INITIAL MACRO   ==>      LOCK      ==> YES (YES, NO or NEVER)

  FORMAT NAME     ==>      MIXED MODE ==> NO (YES or NO)
```

In the edit session, you can type REXX instructions, such as the ones that follow.

```
EDIT ---- USERID.REXX.EXEC(TIMEGAME)----- COLUMNS 009 080
COMMAND ==>                                SCROLL ==> HALF
***** ***** TOP OF DATA *****
000001 /***** REXX *****/
000002 /* This is an interactive REXX exec that compares the time */
000003 /* from a user's watch with computer time. */
000004 /*****
000005
000006 SAY 'What time is it?'
000007 PULL usertime /* Put the user's response
000008                  into a variable called
000009                  "usertime" */
000010 IF usertime = '' THEN
000011   SAY "O.K. Game's over."
000012 ELSE
000013   DO
000014     SAY "The computer says:"
000015     /* TSO system */ "time" /* command */
000016   END
000017
000018 EXIT
***** ***** BOTTOM OF DATA *****
```

Checklist #2: Creating a Data Set with the ALLOCATE Command

1. Type an **ALLOCATE** command at the **READY** prompt to define the attributes of the new data set.

You can use the **ALLOCATE** command to create a PDS instead of using ISPF/PDF panels. If you noted attributes in the Preliminary Checklist #5 on page 187, substitute the attributes from the appropriate system file in the following example. If you are unsure about which system file is appropriate, use the values from **SYSEXEC**.

Note: In the **ALLOCATE** command, specify a record format of VB as **RECFM(v,b)** and a record format of FB as **RECFM(f,b)**.

If your installation has no attribute recommendations and you have no attributes from the Preliminary Checklist, you can use the attributes in the following example.

```
ALLOCATE DA(rexx.exec) NEW DIR(10) SPACE(50,20) DSORG(po)
RECFM(v,b) LRECL(255) BLKSIZE(6120)
```

For more information about the ALLOCATE command, see *z/OS TSO/E REXX User's Guide* and *z/OS TSO/E Command Reference*.

2. **Edit a member of the newly created PDS by selecting the ISPF/PDF EDIT option (option 2) and specifying the PDS name with a member name.**

See the description for this step in the previous checklist #4 on page 189.

Checklist #3: Writing an Exec that Sets up Allocation to SYSEXEC

1. **Write an exec named SETUP that allocates data sets to SYSEXEC.**

Create a data set member named SETUP in your exec PDS. In SETUP issue an ALLOCATE command that concatenates your PDS to the beginning of all the data sets already allocated to SYSEXEC. Include the data sets allocated to SYSEXEC from the list in the "Preliminary Checklist" on page 186. If there are no other data sets allocated to SYSEXEC, specify your PDS only. Your SETUP exec could look like the following example.

Sample SETUP Exec

```

/***** REXX *****/
/* This exec is an example of how to allocate a private PDS named */
/* USERID.REXX.EXEC to the beginning of a concatenation to SYSEXEC */
/* that consists of one other data set named 'ISP.PHONE.EXEC'. To */
/* make sure that SYSEXEC is available, the exec issues EXECUTIL */
/* SEARCHDD(yes) command. After the ALLOCATE command executes, a */
/* message indicates whether the command was successful or not. */
/*****/
"EXECUTIL SEARCHDD(yes)" /* to ensure that SYSEXEC is available*/

"ALLOC FILE(SYSEXEC) DATASET(rexx.exec,",
" 'isp.phone.exec') SHR REUSE"

IF RC = 0 THEN
  SAY 'Allocation to SYSEXEC completed.'
ELSE
  SAY 'Allocation to SYSEXEC failed.'
```

Note: The order in which you list data sets in an ALLOCATE command is the order in which they are concatenated and searched. To give your execs priority in the search order, list your data set of execs before other data sets.

Generally all the data sets in the list should have the same record format (either RECFM=VB or RECFM=FB) and logical record length, LRECL. Also, the first data set in the list can determine the block size, BLKSIZE, for the data sets that follow. If the block size of the first data set is smaller than the block sizes of subsequent data sets, you might end in error. To avoid error, use the Preliminary Checklist and the other checklists provided, and follow directions carefully.

2. **Execute SETUP by entering the following EXEC command:**

```
READY
EXEC rexx.exec(setup) exec
```

If the allocation was successful, you should then see displayed on your screen:

Checklist #3

Allocation to SYSEXEC completed.

To have SETUP execute when you log on and automatically allocate your data set to SYSEXEC, type the same EXEC command in the COMMAND field of your LOGON panel.

```
----- TSO/E LOGON -----
PF1/PF13 ==> Help  PF3/PF15 ==> Logoff  PA1 ==> Attention  PA2 ==> Reshow
You may request specific HELP information by entering a '?' in
any entry field.

ENTER LOGON PARAMETERS BELOW:                RACF LOGON PARAMETERS:

USERID   ==>> YOURID

PASSWORD ==>>

PROCEDURE ==>> MYPROC                        GROUP IDENT ==>>

ACCT NMBR ==>> 00123

SIZE     ==>> 5800

PERFORM  ==>>

COMMAND  ==>> EXEC rexx.exec(setup) exec

ENTER AN 'S' BEFORE EACH OPTION DESIRED BELOW:

-NOMAIL      -NONOTICE      -RECONNECT      -OIDCARD
```

Checklist #4: Writing an Exec that Sets up Allocation to SYSPROC

1. Write an exec named SETUP that allocates data sets to SYSPROC.

Create a data set member named SETUP in your exec PDS. In SETUP issue an ALLOCATE command that concatenates your PDS to the beginning of all the data sets already allocated to SYSPROC. Include the data sets allocated to SYSPROC from the list in the "Preliminary Checklist" on page 186. If there are no other data sets allocated to SYSPROC, specify your PDS only. Your SETUP exec could look like the following example.

Sample SETUP Exec

```

/***** REXX *****/
/* This exec is an example of how to allocate a private PDS named */
/* USERID.REXX.EXEC to the beginning of a concatenation to SYSPROC */
/* that consists of 3 other data sets named 'ICQ.INFOCNTR.ICQCLIB' */
/* 'SYS1.TSO.CLIST', and 'ISP.ISPF.CLISTS'. After the ALLOCATE */
/* command executes, a message indicates whether the command was */
/* successful or not. */
/*****/

      "ALLOC FILE(SYSPROC) DATASET(rexx.exec,",
        "'icq.infocntr.icqclib'",
        "'sys1.tso.clist'",
        "'isp.ispf.clists') SHR REUSE"

IF RC = 0 THEN
  SAY 'Allocation to SYSPROC completed.'
ELSE
  SAY 'Allocation to SYSPROC failed.'

```

Note: The order in which you list data sets in an ALLOCATE command is the order in which they are concatenated and searched. To give your execs priority in the search order, list your data set of execs before other data sets.

Generally all the data sets in the list should have the same record format, (either RECFM=VB or RECFM=FB) and logical record length, LRECL. Also, the first data set in the list can determine the block size, BLKSIZE, for the data sets that follow. If the block size of the first data set is smaller than the block sizes of subsequent data sets, you might end in error. To avoid error, use the Preliminary Checklist and the other checklists provided, and follow directions carefully.

2. **Execute SETUP by entering the following EXEC command:**

```

READY
EXEC rexx.exec(setup) exec

```

If the allocation was successful, you should then see displayed on your screen:

```

Allocation to SYSPROC completed.

```

To have SETUP execute when you log on and automatically allocate your data set to SYSPROC, type the same EXEC command in the COMMAND field of your LOGON panel.

Checklist #4

```
----- TSO/E LOGON -----
PF1/PF13 ==> Help PF3/PF15 ==> Logoff PA1 ==> Attention PA2 ==> Reshow
You may request specific HELP information by entering a '?' in
any entry field.

ENTER LOGON PARAMETERS BELOW:                RACF LOGON PARAMETERS:

USERID   ==> YOURID

PASSWORD ==>

PROCEDURE ==> MYPROC                          GROUP IDENT ==>

ACCT NMBR ==> 00123

SIZE     ==> 5800

PERFORM  ==>

COMMAND  ==> EXEC rexx.exec(setup) exec

ENTER AN 'S' BEFORE EACH OPTION DESIRED BELOW:

        -NOMAIL          -NONOTICE          -RECONNECT          -OIDCARD
```

Appendix B. Specifying Alternate Libraries with the ALTLIB Command

Specifying Alternative Exec Libraries with the ALTLIB Command	195
Using the ALTLIB Command	195
Stacking ALTLIB Requests	196
Using ALTLIB with ISPF	196
Examples of the ALTLIB Command	196

The ALTLIB command gives you more flexibility in specifying exec libraries for implicit execution. With ALTLIB, a user or ISPF application can easily activate and deactivate exec libraries for implicit execution as the need arises. This flexibility can result in less search time when fewer execs are activated for implicit execution at the same time.

In addition to execs, the ALTLIB command lets you specify libraries of CLISTs for implicit execution.

Specifying Alternative Exec Libraries with the ALTLIB Command

The ALTLIB command lets you specify *alternative libraries* to contain implicitly executable execs. You can specify alternative libraries on the user, application, and system levels.

- The *user level* includes exec libraries previously allocated to the file SYSUEXEC or SYSUPROC. During implicit execution, these libraries are searched first.
- The *application level* includes exec libraries specified on the ALTLIB command by data set or file name. During implicit execution, these libraries are searched after user libraries.
- The *system level* includes exec libraries previously allocated to file SYSEXEC or SYSPROC. During implicit execution, these libraries are searched after user or application libraries.

Using the ALTLIB Command

The ALTLIB command offers several functions, which you specify using the following operands:

- | | |
|-------------------|---|
| ACTIVATE | Allows implicit execution of execs in a library or libraries on the specified level(s), in the order specified. |
| DEACTIVATE | Excludes the specified level from the search order. |
| DISPLAY | Displays the current order in which exec libraries are searched for implicit execution. |
| RESET | Resets searching to the system level only (execs allocated to SYSEXEC or SYSPROC). |

For complete information about the syntax of the ALTLIB command, see *z/OS TSO/E Command Reference*.

Notes:

1. With ALTLIB, data sets concatenated to each of the levels can have differing characteristics (logical record length and record format), but the data sets within the same level must have the same characteristics.

Specifying Alternative Exec Libraries ...

2. At the application and system levels, ALTLIB uses the virtual lookaside facility (VLF) to provide potential increases in library search speed.

Stacking ALTLIB Requests

On the application level, you can stack up to eight activate requests with the top, or current, request active. Application-level libraries you define while running an ISPF application are in effect only while that application has control. When the application completes, the original application-level libraries are automatically reactivated.

Using ALTLIB with ISPF

Under ISPF, ALTLIB works the same as in line mode TSO/E. However, if you use ALTLIB under line mode TSO/E and start ISPF, the alternative libraries you specified under line mode TSO/E are unavailable until ISPF ends.

When you use ALTLIB under ISPF, you can pass the alternative library definitions from application to application by using ISPEXEC SELECT with the PASSLIB operand; for example:

```
ISPEXEC SELECT NEWAPPL(ABC) PASSLIB
```

The PASSLIB operand passes the ALTLIB definitions to the invoked application. When the invoked application completes and the invoking application regains control, the ALTLIB definitions that were passed take effect again, regardless of whether the invoked application changed them. If you omit the PASSLIB operand, ALTLIB definitions are not passed to the invoked application.

For more information about writing ISPF applications, see *z/OS ISPF Services Guide*.

Examples of the ALTLIB Command

In the following example, an application issues the ALTLIB command to allow implicit execution of execs in the data set NEW.EXEC, to be searched ahead of SYSPROC:

```
ALTLIB ACTIVATE APPLICATION(exec) DATASET(new.exec)
```

The application could also allow searching for any private execs that the user has allocated to the file SYSUEXEC or SYSUPROC, with the following command:

```
ALTLIB ACTIVATE USER(exec)
```

To display the active libraries in their current search order, use the DISPLAY operand as follows:

```
ALTLIB DISPLAY
```

For more information about the search order EXEC uses for execs and CLISTs, see *z/OS TSO/E Command Reference*.

To deactivate searching for a certain level, use the DEACTIVATE operand; for example, to deactivate searching for execs on the system level (those allocated to SYSEXEC or SYSPROC), issue:

```
ALTLIB DEACTIVATE SYSTEM(exec)
```

And, to reset exec searching back to the system level, issue:

```
ALTLIB RESET
```

Appendix C. Comparisons Between CLIST and REXX

Accessing System Information	198
Controlling Program Flow	199
Debugging	200
Execution	200
Interactive Communication	201
Passing Information.	201
Performing File I/O	202
Syntax	202
Using Functions	203
Using Variables	203

Both the CLIST language and the REXX language can be used in TSO/E as procedures languages. Some major features of REXX that are different from CLIST are:

- Host command environments - TSO/E REXX has the ability to invoke commands from several environments in MVS and ISPF, as well as from TSO/E. The ADDRESS instruction sets the environment for commands. For more information, see “Issuing Other Types of Commands from an Exec” on page 101.
- Parsing capabilities - For separating data into variable names and formatting text, REXX provides extensive parsing through templates. For more information, see “Parsing Data” on page 87.
- Use of a data stack - REXX offers the use of a data stack in which to store data. For more information, see “Chapter 11. Storing Information in the Data Stack” on page 135.
- Use of mixed and lowercase characters - Although variables and most input are translated to uppercase, REXX provides ways to maintain mixed and lowercase representation. For more information, see “Preventing Translation to Uppercase” on page 20.

In some ways CLIST and REXX are similar. The following tables show similarities and differences in the areas of:

- Accessing system services
- Controlling program flow
- Debugging
- Execution
- Interactive communication
- Passing information
- Performing file I/O
- Syntax
- Using functions
- Using variables

Accessing System Information

CLIST	REXX
LISTDSI statement LISTDSI &BASEDS	LISTDSI external function x = LISTDSI(baseds)
&SYSOUTTRAP and &SYSOUTLINE SET SYSOUTTRAP = 100	OUTTRAP external function x = OUTTRAP(var,100)
CONTROL statement CONTROL PROMPT	PROMPT external function x = PROMPT(on)
&SYSDSN built-in function IF &SYSDSN('SYS1.MYLIB') = OK THEN : :	SYSDSN external function IF SYSDSN('SYS1.MYLIB') = OK THEN : :
Control Variables: For User Information &SYSPREF WRITE &SYSPREF &SYSPROC &SYSUID For Terminal Information &SYSLTERM &SYSWTERM For CLIST Information &SYSENV &SYSICMD &SYSISPF &SYSNEST &SYSPCMD &SYSSCMD For System Information &SYSCPU &SYSHSM &SYSJES &SYSLRACF &SYSNODE &SYSRACF &SYSSRV &SYSTEMID &SYSTS0E	Arguments of the SYSVAR external function: For User Information SYSPREF SAY SYSVAR(syspref) SYSPROC SYSUID For Terminal Information SYSLTERM SYSWTERM For Exec Information SYSENV SYSICMD SYSISPF SYSNEST SYSPCMD SYSSCMD For System Information SYSCPU SYSHSM SYSJES SYSLRACF SYSNODE SYSRACF SYSSRV SYSTEMID SYSTS0E

CLIST	REXX
Control Variables:	Arguments of the MVSVAR external function:
For System Information	For System Information
&SYSAPPCLU	SYSAPPCLU
&SYSDFP	SYSDFP
&SYSMVS	SYSMVS
&SYSNAME	SYSNAME
&SYSSECLAB	SYSSECLAB
&SYSSMFID	SYSSMFID
&SYSSMS	SYSSMS
&SYSCLONE	SYSCLONE
&SYSPLEX	SYSPLEX
&SYSSYMDEF	SYMDEF

Controlling Program Flow

CLIST	REXX
Branching	Branching
IF/THEN/ELSE statements	IF/THEN/ELSE instructions
SELECT/WHEN/OTHERWISE/END statements	SELECT/WHEN/OTHERWISE/END instructions
Looping	Looping
Iterative DO	Iterative DO
DO/WHILE/END statements	DO/WHILE/END instructions
DO/UNTIL/END statements	DO/UNTIL/END instructions
Interrupting	Interrupting
END, EXIT statements	EXIT instruction
GOTO statement	SIGNAL instruction
	LEAVE instruction
	CALL instruction
Calling another CLIST	Calling another exec as an external subroutine
EXEC command	CALL instruction
:	:
EXEC MYNEW.CLIST(CLIST1) 'VAR'	call exec1 var
:	:
END	exit
PROC 1 VAR	arg var
:	:
EXIT	return
Calling a subprocedure	Calling an internal subroutine

Controlling Program Flow

CLIST	REXX
SYSCALL statement : SYSCALL SOMESUB VAR : END SOMESUB: PROC 1 VAR : EXIT	CALL instruction : call sub1 var : exit sub1: arg var : return

Debugging

CLIST	REXX
Debugging a CLIST	Debugging an exec
CONTROL SYMLIST LIST CONLIST MSG	TRACE instruction trace i Interactive debug facility (EXECUTIL TS and TRACE ?R)
Return codes for commands and statements	Return codes for commands
&LASTCC, &MAXCC SET ECODE = &LASTCC	RC ecode = RC
Trapping TSO/E command output	Trapping TSO/E command output
&SYSOUTTRAP, &SYSOUTLINE	OUTTRAP external function
Error handling	Error handling
ERROR and ATTN statements	SIGNAL ON ERROR, SIGNAL ON FAILURE, SIGNAL ON HALT, SIGNAL ON NOVALUE, and SIGNAL ON SYNTAX instructions. CALL ON ERROR, CALL ON FAILURE, and CALL ON HALT instructions. ¹
:	
1	For more information about REXX error handling instructions, see <i>z/OS TSO/E REXX Reference</i> .

Execution

CLIST	REXX
Explicit	Explicit
EXEC command EXEC MYNEW.CLIST(CLIST1)	EXEC command EXEC MYNEW.EXEC(FIRST) EXEC

CLIST	REXX
Implicit	Implicit
1. Allocate/concatenate to SYSPROC 2. Specify member name of PDS with or without %	1. Allocate/concatenate to SYSPROC or SYSEXEC 2. Specify member name of PDS with or without %

Interactive Communication

CLIST	REXX
Reading from the terminal	Reading from the terminal
READ, READDVAL statements READ INPUTA, INPUTB, INPUTC	PULL, PARSE PULL, PARSE UPPER PULL, PARSE EXTERNAL instructions pull inputa, inputb, inputc
Writing to the terminal	Writing to the terminal
WRITE statement WRITE Your previous entry was not valid.	SAY instruction say 'Your previous entry was not valid.'

Passing Information

CLIST	REXX
Receiving parameters in a CLIST	Receiving arguments in an exec
PROC statement PROC 1 DSNAME MEMBER() DISP(SHR) CLISTs can receive positional, keyword, and keyword value parameters.	ARG, PARSE ARG, PARSE UPPER ARG instructions arg dsname member disp An exec receives positional parameters. Use the PARSE ARG and PARSE UPPER ARG instructions to receive keywords, for example: my.data member(member1) disp(old) parse upper arg dsname . parse upper arg 'MEMBER('mem')' parse upper arg 'DISP('disp)''
Recognizing comments within a parameter	Recognizing comments within a parameter
A CLIST PROC statement recognizes a comment within a parameter sent by the EXEC command and ignores that comment.	An ARG instruction does not recognize a comment within a parameter sent by the EXEC command. It is treated as part of the argument.
Sending parameters to a CLIST	Sending arguments to an exec
EXEC command EXEC MY.CLIST(NEW) - 'MY.DATA MEMBER(MEMBER1) DISP(OLD)'	EXEC command from TSO/E READY 'EXEC MY.EXEC(NEW)', "'my.data member(member1) disp(old)' EXEC"
Sending information to a subprocedure	Sending information to a subroutine

Passing Information

CLIST	REXX
SYSCALL statement SYSCALL SOMESUB &VAR	CALL instruction call somsub var
Sending information from a subprocedure	Sending information from a subroutine
RETURN statement : : SYSCALL SOMESUB &VAR SET ANSWER = &LASTCC : : END SOMESUB: PROC 1 V1 : : RETURN CODE(33) /* code goes to &LASTCC	RETURN instruction : : call somsub var answer = RESULT exit somesub: arg v1 : : value = 4 * v1 / 3 return value /* value goes to RESULT */

Performing File I/O

CLIST	REXX
Reading from a file	Reading from a file
OPENFILE, GETFILE, CLOFILE statements OPENFILE PAYCHEKS SET COUNTER=1 DO WHILE &COUNTER \> 3 GETFILE PAYCHEKS SET EMPLOYEE&COUNTER=&PAYCHEKS SET COUNTER=&COUNTER+1; END CLOFILE PAYCHEKS	EXECIO DISKR, EXECIO DISKRU commands 'EXECIO 3 DISKR indd (stem employee. FINIS' /* Read 3 records from the data set in indd. */ /* The 3 records go to a list of compound */ /* variables with the stem of employee. They */ /* are employee.1, employee.2 and employee.3 */
Writing to a file	Writing to a file
OPENFILE, PUTFILE, CLOFILE statements OPENFILE PRICES OUTPUT SET PRICES = \$2590.00 PUTFILE PRICES CLOFILE PRICES	EXECIO DISKW push '\$2590.00' /* put amount on data stack */ 'EXECIO 1 DISKW outdd (finis' /*Write from data stack to data set in outdd */

Syntax

CLIST	REXX
Continuing a statement over more than one line	Continuing an instruction over more than one line

CLIST	REXX
Use - or + IF &STR(SYSDATE)=&STR(10/13/87) THEN + WRITE On &SYSDATE the system was down.	Use , say 'This instruction', 'covers two lines.'
Separating statements within a line	Separating instructions within a line
No more than one statement per line	Use ; do 5; Say 'Hello'; end
Character set of statements	Character set of instructions
Must be in uppercase	Can be upper, lower, or mixed case
Comments	Comments
Enclose between /* */, closing delimiter optional at the end of a line.	Enclose between /* */, closing delimiter always required.

Using Functions

CLIST	REXX
Calling a function	Calling a function
&FUNCTION(expression) SET A = &LENGTH(ABCDE) /* &A = 5 */	function(arguments) a = length('abcde') /* a = 5 */

Using Variables

CLIST	REXX
Assigning value to a variable	Assigning value to a variable
SET statement SET X = 5 /* &X gets the value 5 */ SET NUMBER = &X /* &NUMBER gets the value 5 */ SET Y = NUMBER /* &Y gets the value NUMBER */	assignment instruction x = 5 /* X gets the value 5 */ NUMBER = x /* NUMBER gets the value 5 */ Y = 'number' /* Y gets the value number */

Using Variables

Appendix D. Notices

This information was developed for products and services offered in the U.S.A.

IBM may not offer the products, services, or features discussed in this document in other countries. Consult your local IBM representative for information on the products and services currently available in your area. Any reference to an IBM product, program, or service is not intended to state or imply that only that IBM product, program, or service may be used. Any functionally equivalent product, program, or service that does not infringe any IBM intellectual property right may be used instead. However, it is the user's responsibility to evaluate and verify the operation of any non-IBM product, program, or service.

IBM may have patents or pending patent applications covering subject matter described in this document. The furnishing of this document does not give you any license to these patents. You can send license inquiries, in writing, to:

IBM Director of Licensing
IBM Corporation
North Castle Drive
Armonk, NY 10504-1785
USA

For license inquiries regarding double-byte (DBCS) information, contact the IBM Intellectual Property Department in your country or send inquiries, in writing, to:

IBM World Trade Asia Corporation
Licensing
2-31 Roppongi 3-chome, Minato-ku
Tokyo 106, Japan

The following paragraph does not apply to the United Kingdom or any other country where such provisions are inconsistent with local law:

INTERNATIONAL BUSINESS MACHINES CORPORATION PROVIDES THIS PUBLICATION "AS IS" WITHOUT WARRANTY OF ANY KIND, EITHER EXPRESS OR IMPLIED, INCLUDING, BUT NOT LIMITED TO, THE IMPLIED WARRANTIES OF NON-INFRINGEMENT, MERCHANTABILITY OR FITNESS FOR A PARTICULAR PURPOSE. Some states do not allow disclaimer of express or implied warranties in certain transactions, therefore, this statement may not apply to you.

This information could include technical inaccuracies or typographical errors. Changes are periodically made to the information herein; these changes will be incorporated in new editions of the publication. IBM may make improvements and/or changes in the product(s) and/or the program(s) described in this publication at any time without notice.

Any references in this information to non-IBM Web sites are provided for convenience only and do not in any manner serve as an endorsement of those Web sites. The materials at those Web sites are not part of the materials for this IBM product and use of those Web sites is at your own risk.

IBM may use or distribute any of the information you supply in any way it believes appropriate without incurring any obligation to you.

Notices

Licensees of this program who wish to have information about it for the purpose of enabling: (i) the exchange of information between independently created programs and other programs (including this one) and (ii) the mutual use of the information which has been exchanged, should contact:

IBM Corporation
Mail Station P300
2455 South Road
Poughkeepsie, NY 12601-5400
USA

Such information may be available, subject to appropriate terms and conditions, including in some cases, payment of a fee.

The licensed program described in this information and all licensed material available for it are provided by IBM under terms of the IBM Customer Agreement, IBM International Program License Agreement, or any equivalent agreement between us.

Any performance data contained herein was determined in a controlled environment. Therefore, the results obtained in other operating environments may vary significantly. Some measurements may have been made on development-level systems and there is no guarantee that these measurements will be the same on generally available systems. Furthermore, some measurement may have been estimated through extrapolation. Actual results may vary. Users of this document should verify the applicable data for their specific environment.

Information concerning non-IBM products was obtained from the suppliers of those products, their published announcements or other publicly available sources. IBM has not tested those products and cannot confirm the accuracy of performance compatibility or any other claims related to non-IBM products. Questions on the capabilities of non-IBM products should be addressed to the suppliers of those products.

All statements regarding IBM's future direction or intent are subject to change without notice, and represent goals and objectives only.

This information contains examples of data and reports used in daily business operations. To illustrate them as completely as possible, the examples include the names of individuals, companies, brands, and products. All of these names are fictitious and any similarity to the names and addresses used by an actual business enterprise is entirely coincidental.

COPYRIGHT LICENSE:

This information contains sample application programs in source language, which illustrates programming techniques on various operating platforms. You may copy, modify, and distribute these sample programs in any form without payment to IBM, for the purposes of developing, using, marketing or distributing application programs conforming to the application programming interface for the operating platform for which the sample programs are written. These examples have not been thoroughly tested under all conditions. IBM, therefore, cannot guarantee or imply reliability, serviceability, or function of these programs. You may copy, modify, and distribute these sample programs in any form without payment to IBM for the purposes of developing, using, marketing, or distributing application programs conforming to IBM's application programming interfaces.

If you are viewing this information softcopy, the photographs and color illustrations may not appear.

Programming Interface Information

This book documents intended Programming Interfaces that allow the customer to write programs to obtain the services of z/OS TSO/E REXX language processor.

Trademarks

The following terms are trademarks of the IBM Corporation in the United States or other countries or both:

- CICS
- DFSMS/MVS
- IBM
- IBMLink
- IMS
- MVS
- MVS/DFP
- MVS/ESA
- Operating System/2
- Operating System/400
- OS/2
- OS/400
- RACF
- Resource Link
- SAA
- Systems Application Architecture
- z/OS
- zSeries

UNIX is a registered trademark of The Open Group in the United States and other countries.

Other company, product, and service names may be trademarks or service marks of others.

Bibliography

This section lists the books in the TSO/E library and related publications.

TSO/E Publications

TSO/E Publications

- *z/OS TSO/E Administration*, SA22-7780
- *z/OS TSO/E CLISTs*, SA22-7781
- *z/OS TSO/E Command Reference*, SA22-7782
- *z/OS TSO/E Customization*, SA22-7783
- *z/OS TSO/E General Information*, SA22-7784
- *z/OS TSO/E Guide to SRPI*, SA22-7785
- *z/OS TSO/E Messages*, SA22-7786
- *z/OS TSO/E Primer*, SA22-7787
- *z/OS TSO/E Programming Guide*, SA22-7788
- *z/OS TSO/E Programming Services*, SA22-7789
- *z/OS TSO/E REXX Reference*, SA22-7790
- *z/OS TSO/E REXX User's Guide*, SA22-7791
- *z/OS TSO/E System Programming Command Reference*, SA22-7793
- *z/OS TSO/E System Diagnosis: Data Areas*, GA22-7792
- *z/OS TSO/E User's Guide*, SA22-7794

Related Publications

z/OS MVS Publications

- *z/OS MVS Planning: APPC/MVS Management*, SA22-7599
- *z/OS MVS Programming: Writing Transaction Programs for APPC/MVS*, SA22-7621
- *z/OS MVS Initialization and Tuning Reference*, SA22-7592
- *z/OS MVS Programming: Authorized Assembler Services Guide*, SA22-7608
- *z/OS MVS Programming: Authorized Assembler Services Reference ALE-DYN*, SA22-7609
- *z/OS MVS System Messages, Vol 1 (ABA-AOM)*, SA22-7631
- *z/OS MVS System Messages, Vol 2 (ARC-ASA)*, SA22-7632
- *z/OS MVS System Messages, Vol 3 (ASB-BPX)*, SA22-7633
- *z/OS MVS System Messages, Vol 4 (CBD-DMO)*, SA22-7634
- *z/OS MVS System Messages, Vol 5 (EDG-GFS)*, SA22-7635
- *z/OS MVS System Messages, Vol 6 (GOS-IEA)*, SA22-7636
- *z/OS MVS System Messages, Vol 7 (IEB-IEE)*, SA22-7637
- *z/OS MVS System Messages, Vol 8 (IEF-IGD)*, SA22-7638
- *z/OS MVS System Messages, Vol 9 (IGF-IWM)*, SA22-7639
- *z/OS MVS System Messages, Vol 10 (IXC-IZP)*, SA22-7640
- *z/OS MVS System Codes*, SA22-7626
- *z/OS MVS Data Areas, Vol 1 (ABEP-DALT)*, GA22-7581
- *z/OS MVS Data Areas, Vol 2 (DCCB-ITZYRETC)*, GA22-7582

Bibliography

- *z/OS MVS Data Areas, Vol 3 (IVT-RCWK)*, GA22-7583
- *z/OS MVS Data Areas, Vol 4 (RD-SRRA)*, GA22-7584
- *z/OS MVS Data Areas, Vol 5 (SSAG-XTLST)*, GA22-7585

ISPF Publications

- *z/OS ISPF Services Guide*, SC34-4819
- *z/OS ISPF Dialog Developer's Guide and Reference*, SC34-4821

Index

Special Characters

/ 28
* 28
= 31
// 28
** 28
\ 33
% 18, 28
== 31

A

ADDRESS built-in function 107
ADDRESS instruction 106
ALLOCATE command 190, 191, 192
allocation
 description 185
 to a system file 17, 174, 185
 to SYSEXEC 191
 to SYSPROC 192
allocation checklist
 creating a data set with ALLOCATE 190
 creating and editing a data set using ISPF/PDF 187
 preliminary 186
 writing an exec to allocate to SYSEXEC 191
 writing an exec to allocate to SYSPROC 192
ALTLIB command 195
 using under ISPF 196
APPC/MVS services
 using, examples
 APPC/MVS calls 106
 CPI Communications calls 106
ARG built-in function 75, 82
ARG instruction 22, 74, 82, 88
argument 24
 ARG instruction 74, 82
 data set name 98
 definition 24
 in the EXEC command 98
 passing to an exec 24
 used to pass information to a function 82
 used to pass information to a subroutine 74

arguments
 passing 24
 using CALL instruction 24
 using EXEC command 24
 using REXX function call 24
arithmetic operator
 division, type of 29
 priority 29
 type of 28
array 156
assignment instruction 13
ATTACH host command environment 102
ATTCHMVS host command environment 102
ATTCHPGM host command environment 102

B

background (TSO)
 JCL 177
 running an exec 176
batch (MVS)
 JCL 178
 running an exec 178
blank line 14
Boolean 33
built-in function
 ADDRESS 107
 ARG 75
 comparison 63
 conversion 64
 DATATYPE 66
 description 61
 formatting 64
 QUEUED 137, 144
 REXX language 63
 arithmetic 63
 comparison 63
 conversion 64
 formatting 64
 string manipulating 64
 SUBSTR 70

C

CALL/RETURN instruction 57, 71
character, uppercase
 preventing with PARSE 20, 23
 preventing with quotation mark 20
checklist
 creating a data set with ALLOCATE 190
 creating and editing a data set using ISPF/PDF 187
 preliminary 186
 writing an exec to allocate to SYSEXEC 191
 writing an exec to allocate to SYSPROC 192
checklist #1 - creating and editing a data set using
 ISPF/PDF 187
checklist #2 - creating a data set with ALLOCATE 190

- checklist #3 - writing an exec to allocate to SYSEXEC 191
- checklist #4 - writing an exec to allocate to SYSPROC 192
- clause
 - as a subset of an instruction 13
- CLIST
 - comparison to REXX 197
 - invoking an exec 175
 - returning information to an exec 176
 - running from an exec 175
- comma
 - to continue an instruction 10
- commands
 - ALLOCATE 190, 191, 192
 - ALTLIB 195
 - as an instruction 14
 - CONSOLE 102
 - DELSTACK 149
 - DROPBUF 144
 - enclosing in quotation marks 20, 98
 - EXEC 16, 17, 22, 149
 - prompt option 100
 - with data set name as argument 98
 - EXECIO 154
 - EXECUTIL HI 49
 - EXECUTIL SEARCHDD 174
 - EXECUTIL TE 117
 - EXECUTIL TS 114, 115
 - issuing from an exec 101
 - LISTALC STATUS 186
 - LISTDS 187
 - MAKEBUF 143
 - NEWSTACK 148
 - QBUF 144
 - QELEM 145
 - QSTACK 149
 - SUBCOM 107
 - TSO/E REXX 97
- comment
 - beginning an exec 8, 14
 - distinguishing an exec from a CLIST 14
 - identifying as an exec 14
 - to clarify the purpose of an exec 14
- comparison operator
 - equal 31
 - false (0) 31
 - strictly equal 31
 - true (1) 31
 - types of 31
- compiler
 - benefits 5
- Compiler Runtime Processor
 - portability 6
- compound variable
 - changing all variables in an array 86
 - description 85
 - initializing 85
 - used in EXECIO command 156, 158, 161
 - used in LISTDSI 124
 - using stems 86

- concatenation
 - of data sets 185
- concatenation operator
 - type of
 - || 34
 - abuttal 34
 - blank 34
- CONSOLE host command environment 102
- console session 102
- continuation
 - of an instruction 10
- control variable 119
- copy
 - information to and from data sets 159
 - information to compound variables 161
 - information to the end of a data set 160
- CPICOMM host command environment 102, 104

D

- data set
 - adding information with EXECIO command 160
 - adding to SYSEXEC 191
 - adding to SYSPROC 192
 - allocating 7, 185
 - attributes 189
 - concatenation 191, 192
 - copying information with EXECIO command 159
 - creating 7, 185
 - creating in ISPF/PDF 187
 - creating with ALLOCATE 190
 - creating with the ALLOCATE command 190
 - editing 189
 - finding the allocation status of 186
 - fully-qualified vs. non fully-qualified 98
 - library 185
 - name as argument 98
 - naming convention 98
 - partitioned (PDS) 185
 - prefix 98
 - reading information from with EXECIO 155
 - sequential 185
 - to contain an exec 7
 - updating information with EXECIO command 162
 - writing information to with EXECIO 157
- data stack
 - adding an element 136
 - characteristic 140
 - creating a buffer 142
 - creating a new stack 148
 - deleting a private stack 149
 - description 135
 - determining the number of elements on the stack 137
 - dropping one or more buffers 144
 - finding the number of buffers 144
 - finding the number of elements in 145
 - finding the number of stacks 149
 - manipulating 136
 - passing information between an exec and a routine 140
 - passing information to an interactive command 142

- data stack (*continued*)
 - protecting an element 147
 - removing an element 137
 - removing an element from a stack with a buffer 143
 - search order for processing 139
 - type of input 139
 - using in MVS batch 180
 - using in TSO/E background 180
- DATATYPE built-in function 66
- DBCS 14
- ddname
 - allocating to for I/O 156, 158
 - use in EXECIO command 156, 158
- debug
 - for error 111
 - interactive debug facility 113, 114
 - with REXX special variable 112, 113
- DELSTACK command 149
- diagnosis
 - problem within an exec 111
- DO/END instruction 47
- DO FOREVER loop 49
- DO UNTIL loop
 - flowchart 53
- DO WHILE loop
 - flowchart 52
- double-byte character set names
 - in execs 14
- DROPBUF command 144

E

- edit
 - an exec 189
- environment
 - defining in REXX 181
 - host command 101
 - language processor 181
- error
 - debugging 37, 111
 - tracing command 111
 - tracing expression 37
- error message
 - getting more information 19
 - interpreting 19
 - syntax error 19
- example
 - use of uppercase and lowercase xiv
- exclusive OR 33
- exec
 - allocating to a file 17
 - comment line 8
 - description xiii, 8
 - editing in ISPF 189
 - example 8
 - identifying as an exec 8
 - interactive 8
 - invoking a CLIST 175
 - invoking as a command 100
 - passing information to 21
 - prompting a user for input to a TSO/E command 100

- exec (*continued*)
 - prompting the user for input to a TSO/E command 124, 149
 - receiving input 22
 - returning information to a CLIST 176
 - running
 - error message 19
 - explicitly 16, 173
 - from a CLIST 173, 175
 - from another exec 173
 - implicitly 17, 173, 185
 - implicitly with ALTLIB 195
 - in a TSO/E address space 173
 - in non-TSO/E address space 177
 - in the background 176
 - in the foreground 173
 - where to run 16, 17
 - with % 18
 - with IKJEFT01 176, 177
 - with IRXEXEC 177
 - with IRXJCL 178
 - with JCL 177
 - service available 171
 - using blank line 14
 - using double-byte character set names 14
 - writing 8
- EXEC command 16, 17, 22, 149
 - prompt option 100
 - with data set name as argument 98
- exec identifier 8, 14, 174
- EXECIO command
 - adding information to a data set 160
 - copying information to a data set 159
 - copying information to and from compound variables 161
 - description 154
 - example 163
 - reading information from a data set 155
 - return code 159
 - updating information to a data set 162
 - writing information to a data set 157
- EXECUTIL HI command 49
- EXECUTIL SEARCHDD 174
- EXECUTIL TE command 117
- EXECUTIL TS command 114, 115
- EXIT instruction 57, 71, 78
- explicit execution
 - EXEC command 16, 17
 - from ISPF/PDF command line 17
 - from ISPF/PDF command option 16
 - from READY 16
- expression
 - arithmetic 28
 - order of evaluation 29
 - Boolean 32
 - comparison 30
 - concatenation 34
 - definition 28
 - logical 32
 - tracing 37

- external function
 - TSO/E
 - description 119
 - GETMSG 120
 - LISTDSI 120
 - MSG 122
 - OUTTRAP 123
 - PROMPT 124
 - SETLANG 125
 - STORAGE 126
 - SYSDSN 126
 - SYSVAR 127
- external subroutine 71

F

- FIFO (first in first out) 135
- file 195
- file I/O 154
- foreground processing
 - explicit execution 173
 - implicit execution 173
 - of an exec 173
- function
 - ADDRESS built-in 107
 - ARG built-in 75, 82
 - argument 61
 - built-in
 - arithmetic 63
 - comparison 63
 - conversion 64
 - formatting 64
 - string manipulating 64
 - testing input with 66
 - comparison to a subroutine 69, 83
 - description 69
 - built-in 61
 - function package 61, 133
 - TSO/E external 61, 119
 - user-written 61
 - exposing a specific variable 81
 - external 78
 - internal 78
 - passing information to 81
 - possible problem 80
 - using a variable 79
 - PROMPT 100
 - protecting a variable 80
 - QUEUED built-in 137, 144
 - receiving information from 83
 - using the ARG built-in function 82
 - returning a value 62
 - search order 134
 - TSO/E external
 - description 119
 - GETMSG 120
 - LISTDSI 120
 - MSG 122
 - MVSVAR 123
 - OUTTRAP 123
 - PROMPT 124
 - SETLANG 125

- function (*continued*)
 - TSO/E external (*continued*)
 - STORAGE 126
 - SYSCPUS 126
 - SYSDSN 126
 - SYSVAR 127
 - using EXIT 78
 - using PROCEDURE 80
 - using PROCEDURE EXPOSE 81
 - using RETURN 78
 - when to make internal or external 79
 - writing 77
- function package
 - description 133
 - local 134
 - system 134
 - user 134

G

- GETMSG external function 119, 120
- GOTO 58

H

- HE (halt execution) 49
- HI (halt interpretation) 49
- host command environment 101
 - APPC/MVS 104
 - changing 106
 - checking if it is available 107
 - compared to language processor environment 181
 - default 101, 103
 - description 101
 - finding the active environment 107

I

- IBM Compiler for REXX/370
 - benefits 5
- IBM Library for REXX/370
 - benefits 5
- identifier
 - of an exec 8, 14, 174
- IF/THEN/ELSE instruction
 - flowchart 42
 - matching clauses 43
 - nested 43
 - using DO and END 43
 - using NOP 43
- IKJEFT01 176, 177
- implicit execution 17, 185
 - from ISPF/PDF command line 18
 - from ISPF/PDF command option 17
 - from READY 17
 - speeding up search time 18
 - using % 18
- inclusive OR 33
- infinite loop
 - from TSO/E background and MVS batch 180
 - stopping 48

- input
 - passing argument 24
 - preventing translation to uppercase 23
 - receiving with ARG 22
 - receiving with PULL 21
 - sending with EXEC command 22
 - to an exec
 - preventing translation to uppercase 20, 23
 - using a period as a place holder 23
- input/output (I/O)
 - allocating a ddname 156, 158
 - reading from a data set 155
 - reading to compound variables 156, 158
 - using the EXECIO command 154
 - writing from compound variables 158
 - writing to a data set 157
- instruction 71
 - adding during interactive trace 116
 - ADDRESS 106
 - ARG 22, 74, 82, 88
 - blank 14
 - CALL/RETURN 57
 - comment 14
 - conditional 41
 - continuing to the next line 10
 - DO/END 47
 - DO FOREVER 49
 - DO UNTIL 53
 - DO WHILE 52
 - entering 9
 - EXIT 57, 71, 78, 117
 - formatting 10
 - IF/THEN/ELSE 42
 - INTERPRET 153
 - interrupt 41
 - ITERATE 50
 - LEAVE 50, 55
 - literal string 9
 - looping 41
 - PARSE 20, 23
 - PARSE ARG 88
 - PARSE EXTERNAL 140
 - PARSE PULL 88, 137
 - PARSE UPPER ARG 88
 - PARSE UPPER PULL 88
 - PARSE UPPER VALUE 89
 - PARSE UPPER VAR 89
 - PARSE VALUE...WITH 89
 - PARSE VAR 89
 - PROCEDURE 73, 80
 - PROCEDURE EXPOSE 74, 81
 - PULL 21, 88, 137
 - PUSH 136
 - QUEUE 136
 - re-executing during interactive trace 116
 - SAY 8
 - SELECT/WHEN/OTHERWISE/END 44
 - SIGNAL 58
 - SIGNAL ON ERROR 113
 - syntax 9
- instruction 71 (*continued*)
 - TRACE
 - ending tracing 117
 - interactive tracing 114
 - tracing command 111
 - tracing expression 37
 - type of
 - assignment 13
 - command 14
 - keyword 13
 - label 14
 - null 14
 - using blank 10
 - using comma 10
 - using quotation mark 9, 98
 - using semicolon 11
 - writing 9
- interactive debug facility
 - adding an instruction 116
 - continuing 116
 - description 113
 - ending 116
 - option 116
 - re-executing the last instruction traced 116
 - starting 114
- interactive trace 116
- internal function 78
- internal subroutine 71
- INTERPRET instruction 153
- IRXEXEC 177
- IRXJCL 178
- ISPEXEC host command environment 102
- ISREDIT host command environment 102
- ITERATE instruction 50

J

- JCL (job control language)
 - in MVS batch 178
 - in TSO background 177

K

- keyword instruction 13

L

- label instruction 14
- language processor environment 181
 - compared to host command environment 181
 - customizing 182
 - definition 181
 - IRXISPRM 181
 - IRXPARMs 181
 - IRXTSPRM 181
- LEAVE instruction 50, 55
- library
 - alternative (ALTLIB) 195
 - application level 195
 - exec 185
 - system 185

- library (*continued*)
 - SYSEXEC 17, 174
 - SYSPROC 17, 174
 - system level 195
 - user-level 195
- LIFO (last in first out) 135
- LINK host command environment 102
- LINKMVS host command environment 102
- LINKPGM host command environment 102
- LISTALC STATUS command 186
- LISTDS command 187
- LISTDSI external function 120
- literal string 9
- logical (Boolean) operator
 - false (0) 33
 - true (1) 33
 - type of 33
- logical AND 33
- logical NOT 33
- loop
 - altering the flow 50
 - combining types 55
 - conditional 52
 - DO/END 47
 - DO FOREVER 49
 - DO UNTIL 53
 - DO WHILE 52
 - exiting prematurely 50
 - infinite 48, 49
 - ITERATE 50
 - LEAVE 50
 - nested DO loop 55
 - repetitive 47
 - stopping 48
- lowercase character
 - changing to uppercase 20, 23
 - preventing the change to uppercase 20, 23
- LU62 host command environment 102, 105

M

- MAKEBUF command 143
- message
 - error 19
 - getting more information 19
 - explanation 19
 - interpreting 19
 - tracing 37
- MFJOB 129
- MFOSNM 129
- MFSNMJBX 129
- MFTIME 129
- move
 - information from one data set to another 159
- MVS batch
 - comparison to TSO/E background 180
 - running an exec 178
 - using IRXJCL 178
 - using the data stack 180
- MVS host command environment 102
- MVSVAR external function 123

N

- name for variable
 - restriction on naming 26
 - valid name 26
- NEWSTACK command 148
- non-TSO/E address space
 - running an exec 177
- Notices 205
- null instruction 14
- numeric constant
 - decimal number 28
 - floating point number 28
 - signed number 28
 - whole number 28

O

- operator
 - arithmetic 28
 - order of priority 29
 - Boolean 33
 - comparison 30
 - concatenation 34
 - logical 33
 - order of priority 35
- OUTTRAP external function 123

P

- parameter 24
- parentheses 98
- PARSE ARG instruction 88
- PARSE EXTERNAL instruction 140
- PARSE instruction
 - preventing translation to uppercase 20, 23
- PARSE PULL instruction 88, 137
- PARSE UPPER ARG instruction 88
- PARSE UPPER PULL instruction 88
- PARSE UPPER VALUE instruction 89
- PARSE UPPER VAR instruction 89
- PARSE VALUE...WITH instruction 89
- PARSE VAR instruction 89
- parsing
 - description 87
 - instruction
 - ARG 88
 - PARSE ARG 88
 - PARSE PULL 88
 - PARSE UPPER ARG 88
 - PARSE UPPER PULL 88
 - PARSE UPPER VALUE 89
 - PARSE UPPER VAR 89
 - PARSE VALUE...WITH 89
 - PARSE VAR 89
 - PULL 88
- multiple strings 92
- separator
 - blank 89
 - number 90
 - string 90
 - variable 90

- parsing (*continued*)
 - template 89
- partitioned data set
 - creating in ISPF/PDF 187
 - creating with ALLOCATE 190
 - description 185
 - for an exec 7
- passing arguments 24
- PDS 7
- period
 - as place holder 23
- portability of compiled REXX programs 6
- prefix
 - in a data set name 7, 98
- preliminary checklist 186
- PROCEDURE instruction 73, 74, 80, 81
- Procedures Language xiii
- prompt
 - from TSO/E command 100, 124
 - overridden by an item in the data stack 147
 - overridden by item in the data stack 100
 - overridden by NOPROMPT in the PROFILE 100, 125
- PROMPT external function 124
- PROMPT function 100, 149
- protection
 - of an element on a data stack 147
- PULL instruction 21, 88, 137
- PUSH instruction 136

Q

- QBUF command 144
- QELEM command 145
- QSTACK command 149
- queue
 - description 135
 - FIFO order 135
- QUEUE instruction 136
- QUEUED built-in function 137, 144
- quotation mark 98
 - around a literal string 9
 - around command 20, 98
 - in an instruction 9
 - to prevent translation to uppercase 20

R

- RC special variable
 - for debugging 112
 - used with a command 97
 - used with stack command 144, 145, 149
- repetitive loop 47
- RESULT special variable 75, 100
 - used with EXIT 57
- REXX compiler
 - benefits 5
- REXX environment
 - definition 181
- REXX exec identifier 8, 14, 174
- REXX instruction 71
 - adding during interactive trace 116

- REXX instruction 71 (*continued*)
 - ADDRESS 106
 - ARG 22, 74, 82, 88
 - blank 14
 - CALL/RETURN 57
 - comment 14
 - conditional 41
 - continuing to the next line 10
 - DO/END 47
 - DO FOREVER 49
 - DO UNTIL 53
 - DO WHILE 52
 - entering 9
 - EXIT 57, 71, 78, 117
 - formatting 10
 - IF/THEN/ELSE 42
 - INTERPRET 153
 - interrupt 41
 - ITERATE 50
 - LEAVE 50, 55
 - literal string 9
 - looping 41
 - PARSE 20, 23
 - PARSE ARG 88
 - PARSE EXTERNAL 140
 - PARSE PULL 88, 137
 - PARSE UPPER ARG 88
 - PARSE UPPER PULL 88
 - PARSE UPPER VALUE 89
 - PARSE UPPER VAR 89
 - PARSE VALUE...WITH 89
 - PARSE VAR 89
 - PROCEDURE 73, 80
 - PROCEDURE EXPOSE 74, 81
 - PULL 21, 88, 137
 - PUSH 136
 - QUEUE 136
 - re-executing during interactive trace 116
 - SAY 8
 - SELECT/WHEN/OTHERWISE/END 44
 - SIGNAL 58
 - SIGNAL ON ERROR 113
 - syntax 9
 - TRACE
 - ending tracing 117
 - interactive tracing 114
 - tracing command 111
 - tracing expression 37
 - type of
 - assignment 13
 - command 14
 - keyword 13
 - label 14
 - null 14
 - using blank 10
 - using comma 10
 - using quotation mark 9, 98
 - using semicolon 11
 - writing 9
- REXX language
 - comparison to CLIST 197

- REXX language *(continued)*
 - description 3
 - example
 - use of uppercase and lowercase xiv
 - exec
 - description xiii, 8
 - feature of 3
 - program (exec) xiii
 - REstructured eXtended eXecutor xiii
 - SAA (Systems Application Architecture) xiii, 4
- REXX program
 - portability of 6
- REXX special variable
 - RC
 - for debugging 112
 - used with a command 97
 - used with stack command 144, 145, 149
 - RESULT 75, 100
 - used with EXIT 57
 - SIGL
 - for debugging 112, 113
- rules
 - syntax 9

S

- SAA (Systems Application Architecture) xiii
 - general description 6
 - Procedures Language 4
- SAA Procedures Language 6
- SAY instruction 8
- SELECT/WHEN/OTHERWISE/END instruction
 - flowchart 44
- semicolon
 - to end an instruction 11
- service
 - for REXX in MVS 171
- SETLANG external function
 - valid language codes 125
- SIGL special variable
 - for debugging 112, 113
- SIGNAL instruction 58
- SIGNAL ON ERROR instruction 113
- SOLDISP 129
- SOLNUM 129
- special variable 100
- stack 135
- stem
 - used with OUTTRAP function 123
- STORAGE external function 126
- string 9
- SUBCOM command 107
- subcommand environment 101
- SUBMIT command 177
- subroutine
 - calling 57
 - comparison to a function 69, 83
 - description 69
 - exposing a specific variable 74
 - external 71
 - internal 71

- subroutine *(continued)*
 - passing information
 - using an argument 74
 - passing information to
 - possible problem 72
 - using a variable 72
 - protecting variable 73
 - receiving information from
 - RESULT 75
 - using the ARG built-in function 75
 - returning a value 57
 - using CALL/RETURN 70
 - using PROCEDURE 73
 - using PROCEDURE EXPOSE 74
 - when to make internal or external 71
 - writing 70
- SUBSTR built-in function 70
- SYMDEF 123
- syntax
 - rules of REXX 9
- SYSAPPCLU 123
- SYSCLONE 123
- SYSCPU 128
- SYSCPUS external function 126
- SYSDFP 123
- SYSDSN external function 126
- SYSDTERM 128
- SYSENV 128
- SYSEXEC 17, 174
 - allocating to 191
- SYSEXEC system file
 - reason to allocate to 174
- SYSHSM 129
- SYSICMD 128
- SYSISPF 128
- SYSJES 129
- SYKTERM 128
- SYSLRACF 129
- SYSLTERM 128
- SYSMVS 123
- SYSNAME 123
- SYSNEST 128
- SYSNODE 129
- SYSPCMD 128
- SYSPLANG 128
- SYSPLEX 123
- SYSREF 128
- SYSPROC 14, 17, 128, 174
 - allocating to 192
- SYSPROC system file
 - reason to allocate to 174
- SYSRACF 129
- SYSSCMD 128
- SYSSECLAB 123
- SYSSLANG 128
- SYSSMFID 123
- SYSSMS 123
- SYSSRV 129
- system file
 - allocating to 17, 174, 185
 - reason to allocate to 174

system file (*continued*)
 SYSEXEC 17, 174, 195
 SYSPROC 14, 17, 174, 195
 SYSUEXEC 195
 SYSUPROC 195
 Systems Application Architecture (SAA)
 Procedures Language xiii
 SYSTEMID 129
 SYSTSOE 129
 SYSUEXEC 195
 SYSUID 128
 SYSUPROC 195
 SYSVAR external function 127
 SYSWTERM 128

T

template 89
 trace 116
 TRACE instruction 111
 ending tracing 117
 interactive tracing 114
 tracing operation 37
 tracing result 38
 TSO/E background
 comparison to MVS batch 180
 using the data stack 180
 TSO/E commands
 ALLOCATE 190, 191, 192
 ALTLIB 195
 EXEC 16, 17, 22, 149
 prompt option 100
 with data set name as argument 98
 EXECUTIL HI 49
 EXECUTIL SEARCHDD 174
 EXECUTIL TE 117
 EXECUTIL TS 114, 115
 issuing from an exec 98
 LISTALC STATUS 186
 LISTDS 187
 prompting 100, 124
 overridden by item in the data stack 100
 overridden by NOPROMPT in the PROFILE 100
 SUBMIT 177
 using parentheses 98
 using quotation mark 98
 using variable 99
 with interactive prompt 100, 124, 149
 TSO/E environment service
 description 119
 JCL example 177
 running an exec 177
 TSO/E external function
 description 119
 GETMSG 120
 LISTDSI 120
 MSG 122
 MVSVAR 123
 OUTTRAP 123
 PROMPT 124
 SETLANG 125
 STORAGE 126

TSO/E external function (*continued*)
 SYSCPUS 126
 SYSDSN 126
 SYSVAR 127
 TSO/E REXX command
 DELSTACK 149
 description 97
 DROPBUF 144
 EXECIO 154
 EXECUTIL HI 49
 EXECUTIL SEARCHDD 174
 EXECUTIL TE 117
 EXECUTIL TS 114, 115
 MAKEBUF 143
 NEWSTACK 148
 QBUF 144
 QELEM 145
 QSTACK 149
 SUBCOM 107
 TSO host command environment 102

U

UNSDISP 129
 UNSNUM 129
 uppercase character
 changing from lowercase 20, 23
 preventing the change to 20, 23

V

variable
 compound 85
 control 48
 description 25
 naming 26
 RC 26
 representing a value in quotation marks 99
 restriction on naming 26
 RESULT 26
 shared variable in an internal function 79
 shared variable in an internal subroutine 72
 SIGL 26
 stem 86
 type of value 27
 used to pass information to a function 79
 used to pass information to a subroutine 72
 valid name 26
 value 27
 within TSO/E command 99
 variable of a stem
 description 86, 123
 used with EXECIO function 156, 158
 used with OUTTRAP function 86, 123
 VLF data repository
 file compression 174

Readers' Comments — We'd Like to Hear from You

z/OS
TSO/E
REXX User's Guide

Publication No. SA22-7791-01

Overall, how satisfied are you with the information in this book?

	Very Satisfied	Satisfied	Neutral	Dissatisfied	Very Dissatisfied
Overall satisfaction	<input type="checkbox"/>	<input type="checkbox"/>	<input type="checkbox"/>	<input type="checkbox"/>	<input type="checkbox"/>

How satisfied are you that the information in this book is:

	Very Satisfied	Satisfied	Neutral	Dissatisfied	Very Dissatisfied
Accurate	<input type="checkbox"/>	<input type="checkbox"/>	<input type="checkbox"/>	<input type="checkbox"/>	<input type="checkbox"/>
Complete	<input type="checkbox"/>	<input type="checkbox"/>	<input type="checkbox"/>	<input type="checkbox"/>	<input type="checkbox"/>
Easy to find	<input type="checkbox"/>	<input type="checkbox"/>	<input type="checkbox"/>	<input type="checkbox"/>	<input type="checkbox"/>
Easy to understand	<input type="checkbox"/>	<input type="checkbox"/>	<input type="checkbox"/>	<input type="checkbox"/>	<input type="checkbox"/>
Well organized	<input type="checkbox"/>	<input type="checkbox"/>	<input type="checkbox"/>	<input type="checkbox"/>	<input type="checkbox"/>
Applicable to your tasks	<input type="checkbox"/>	<input type="checkbox"/>	<input type="checkbox"/>	<input type="checkbox"/>	<input type="checkbox"/>

Please tell us how we can improve this book:

Thank you for your responses. May we contact you? Yes No

When you send comments to IBM, you grant IBM a nonexclusive right to use or distribute your comments in any way it believes appropriate without incurring any obligation to you.

Name

Address

Company or Organization

Phone No.



Fold and Tape

Please do not staple

Fold and Tape



NO POSTAGE
NECESSARY
IF MAILED IN THE
UNITED STATES

BUSINESS REPLY MAIL

FIRST-CLASS MAIL PERMIT NO. 40 ARMONK, NEW YORK

POSTAGE WILL BE PAID BY ADDRESSEE

IBM Corporation
Department 55JA, Mail Station P384
2455 South Road
Poughkeepsie, NY
12601-5400



Fold and Tape

Please do not staple

Fold and Tape



Program Number: 5694-A01



Printed in the United States of America
on recycled paper containing 10%
recovered post-consumer fiber.

SA22-7791-01

