

z/OS



TSO/E CLISTS

z/OS



TSO/E CLISTS

Note

Before using this information and the product it supports, be sure to read the general information under "Notices" on page 183.

Third Edition, September 2002

This edition applies to Version 1 Release 4 of z/OS (5694-A01), and Version 1, Release 4 of z/OS.e (5655-G52), and to all subsequent releases and modifications until otherwise indicated in new editions.

This is a major revision of SA22-7781-01.

IBM® welcomes your comments. A form for readers' comments may be provided at the back of this document, or you may address your comments to the following address:

International Business Machines Corporation
Department 55JA, Mail Station P384
2455 South Road
Poughkeepsie, NY 12601-5400
United States of America

FAX (United States & Canada): 1+845+432-9405

FAX (Other Countries):

Your International Access Code +1+845+432-9405

IBMLink™ (United States customers only): IBMUSM10(MHVRCFS)

Internet e-mail: mhvrdfs@us.ibm.com

World Wide Web: <http://www.ibm.com/servers/eserver/zseries/zos/webqs.html>

If you would like a reply, be sure to include your name, address, telephone number, or FAX number.

Make sure to include the following in your comment or note:

- Title and order number of this document
- Page number or topic related to your comment

When you send information to IBM, you grant IBM a nonexclusive right to use or distribute the information in any way it believes appropriate without incurring any obligation to you.

© **Copyright International Business Machines Corporation 1988, 2002. All rights reserved.**

US Government Users Restricted Rights – Use, duplication or disclosure restricted by GSA ADP Schedule Contract with IBM Corp.

Contents

Figures	ix
Tables	xi
About this document	xiii
Who should use this document	xiii
How this document is organized	xiii
Where to find more information	xiv
Accessing licensed books on the Web	xiv
Using LookAt to look up message explanations	xiv
Summary of changes	xvii
Chapter 1. Introduction	1
Features of the CLIST Language	1
Categories of CLISTs	1
CLISTs That Perform Routine Tasks	1
CLISTs That Are Structured Applications	2
CLISTs That Manage Applications Written in Other Languages	2
Chapter 2. Creating, Editing, and Executing CLISTs	3
CLIST Data Sets and Libraries	3
Creating and Editing CLIST Data Sets	3
CLIST Data Set Attributes	4
Considerations for Copying CLIST Data Sets	4
Executing CLISTs	5
Passing Parameters to CLISTs	6
Allocating CLIST Libraries for Implicit Execution	6
Specifying Alternative CLIST Libraries with the ALTLIB Command	7
Examples of the ALTLIB Command	8
Chapter 3. Writing CLISTs - Syntax and Conventions	9
Overview of CLIST Statements	9
Syntax Rules	10
Delimiters	10
Continuation Symbols	10
Capitalization	10
Formatting	11
Length	11
Labels	11
Comments	11
Characters Supported in CLISTs	12
TSO/E Commands and JCL Statements	12
TSO/E Commands	12
JCL Statements	12
Operators and Expressions	13
Order of Evaluations	14
Valid Numeric Ranges	15
The Double-Byte Character Set (DBCS)	15
DBCS Delimiters	15
DBCS Restrictions	15
Chapter 4. Using Symbolic Variables	17

What is a Symbolic Variable?	17
Valid Names of Variables	18
Valid Values of Variables	18
Defining Symbolic Variables and Assigning Values to Them	19
Using the SET Statement	19
Using the READ Statement	19
Using the PROC Statement	20
Examples	22
More Advanced Uses of Variables	22
Combining Symbolic Variables	23
Using a Variable to Preserve Leading Spaces in a CLIST	23
Nesting Symbolic Variables	24
Chapter 5. Using Control Variables.	27
Overview of using Control Variables	28
Getting the Current Date and Time	32
&SYSDATE, &SYSSDATE, and &SYSJDATE	32
&SYS4DATE, &SYS4SDATE, and &SYS4JDATE	33
&SYSTIME and &SYSSTIME	33
Getting Terminal Characteristics	33
&SYSTEMID	34
&SYSLTERM and &SYSWTERM	34
Getting Information about the User	34
&SYSUID	34
&SYSPREF	34
&SYSPROC	35
Getting Information about the System	35
&SYSCLONE	35
&SYSCPU and &SYSSRV	36
&SYSDFP	36
&SYSHSM	36
&SYSISPF	37
&SYSJES	37
&SYSLRACF	37
&SYSAPPCLU	37
&SYSMVS	38
&SYSNAME	38
&SYSNODE	38
&SYSOPSYS	39
&SYSRACF	39
&SYSPLEX	39
&SYSSECLAB	40
&SYSSMS	40
&SYSSMFID	40
&SYSSYMDEF	40
&SYSTSOE	41
Getting Information about the CLIST	41
&SYSENV	41
&SYSSCAN	42
&SYSICMD	42
&SYSPCMD	42
&SYSSCMD	42
Relationship between &SYSPCMD and &SYSSCMD	42
&SYSNEST	42
Setting Options of the CLIST CONTROL Statement	42
&SYSPROMPT	43

&SYSSYMLIST	43
&SYSCONLIST	43
&SYSLIST	43
&SYSASIS	44
&SYSMSG	44
&SYSFLUSH	44
Getting Information about User Input	45
&SYSDLM	45
&SYSDVAL	45
Trapping TSO/E Command Output	46
&SYSOUTTRAP	46
&SYSOUTLINE	46
Considerations for Using &SYSOUTTRAP and &SYSOUTLINE	47
Getting Return Codes and Reason Codes	47
&LASTCC	47
&MAXCC	48
Getting Results of the TSOEXEC Command	49
Getting Data Set Attributes	49
The LISTDSI Statement	49
Chapter 6. Using Built-in Functions	51
Determining the Data Type of an Expression - &DATATYPE	52
Forcing Arithmetic Evaluations - &EVAL	53
Determining an Expression's Length in Bytes - &LENGTH	53
Suppressing Arithmetic Evaluations	53
Including Leading and Trailing Blanks and Leading Zeros	54
Determining an Expression's Length in Characters - &SYSLENGTH	54
Preserving Double Ampersands - &NRSTR	54
Double Ampersands	54
One Level of Symbolic Substitution	54
Records Containing JCL Statements	55
Defining Character Data - &STR	55
Using &STR with &SYSDATE or &SYSSDATE	56
Using &STR with Leading and Trailing Blanks	56
Using &STR with Strings that Match CLIST Statement Names	56
Using &STR When Supplying Input Using SYSIN JCL Statements	56
Defining a Substring - &SUBSTR	57
Defining a Substring - &SYSCSUBSTR	59
Converting Character Strings to Uppercase Characters - &SYSCAPS	59
Converting Character Strings to Lowercase Characters - &SYSLC	59
Determining Data Set Availability - &SYSDSN	59
Locating One Character String Within Another - &SYSINDEX	60
Using &SYSINDEX with DBCS Strings	61
Limiting the Level of Symbolic Substitution - &SYSNSUB	62
Converting DBCS Data to EBCDIC - &SYSONEBYTE	63
Converting EBCDIC Data to DBCS - &SYSTWOBYTE	63
Chapter 7. Structuring CLISTs	65
Making Selections	66
The IF-THEN-ELSE Sequence	66
Nesting IF-THEN-ELSE Sequences	67
The SELECT Statement	68
Loops	70
The DO-WHILE-END Sequence	70
The DO-UNTIL-END Sequence	71
The Iterative DO Sequence	71

Compound DO Sequences	72
Nesting Loops	73
Distinguishing END Statements from END Commands or Subcommands	74
Subprocedures	75
Calling a Subprocedure.	75
Returning Information from a Subprocedure	76
Sharing Variables among Subprocedures	77
Restricting Variables to a Subprocedure.	78
Considerations for Using Other Statements in Subprocedures	78
Nesting CLISTS.	79
Protecting the Input Stack from Errors or Attention Interrupts	79
Global Variables	80
Exiting from a Nested CLIST.	80
GOTO Statements	81
Chapter 8. Communicating with the Terminal User	83
Prompting the User for Input	83
Prompting with the PROC Statement.	83
Prompting with the WRITE and WRITENR Statements	84
Prompting with TSO/E Commands.	84
Writing Messages to the Terminal	86
Using the WRITE and WRITENR Statements.	87
Controlling the Display of Informational Messages	87
Receiving Responses from the Terminal	88
Using the READ Statement	88
Using the READDVAL Statement	91
Passing Control to the Terminal.	92
Returning Control After a TERMIN or TERMING Statement	93
Entering Input After a TERMIN or TERMING Statement	93
Using ISPF Panels	94
ISPF Restrictions	94
Sample CLIST with ISPF Panels	94
Chapter 9. Performing File I/O	95
Characters Supported in I/O	95
Opening a File	95
Closing a File	96
Reading a Record from a File	96
Writing a Record to a File	97
Updating a File	98
End-of-File Processing	98
Special Considerations for Performing I/O	99
Chapter 10. Writing ATTN and ERROR Routines	101
Writing Attention Routines	101
Cancelling Attention Routines	102
Protecting the Input Stack from Attention Interrupts	102
Sample CLIST with an Attention Routine	102
Subprocedures and Attention Routines.	104
CLIST Attention Facility	104
Writing Error Routines.	105
Cancelling Error Routines	105
Protecting the Input Stack from Errors	106
Sample CLIST with an Error Routine	106
Subprocedures and Error Routines	106

Chapter 11. Testing and Debugging CLISTs	109
Using Diagnostic Options of the CONTROL Statement	109
Messages in Diagnostic Output	110
How to Make Diagnostic Output Optional in a CLIST	111
Getting Help for CLIST Messages	111
Obtaining CLIST Error Codes	111
Chapter 12. Sample CLISTs	117
Including TSO/E Commands - The LISTER CLIST	118
Simplifying Routine Tasks - The DELETEDS CLIST	118
Creating Arithmetic Expressions from User-Supplied Input - The CALC CLIST	119
Using Front-End Prompting - The CALCFTND CLIST	119
Initializing and Invoking System Services - The SCRIPTDS CLIST	121
Invoking CLISTs to Perform Subtasks - The SCRIPTN CLIST	122
Including JCL Statements - The SUBMITDS CLIST	125
Analyzing Input Strings with &SUBSTR - The SUBMITFQ CLIST	125
Allowing Foreground and Background Execution of Programs - The RUNPRICE CLIST	126
Including Options - The TESTDYN CLIST	127
Simplifying System-Related Tasks - The COMPRESS CLIST	129
Simplifying Interfaces to Applications - The CASH CLIST	131
Using &SYSDVAL When Performing I/O - The PHONE CLIST	132
Allocating Data Sets to SYSPROC - The SPROC CLIST	133
Writing Full-Screen Applications Using ISPF Dialogs - The PROFILE CLIST	137
Allocating a Data Set with LISTDSI Information - The EXPAND CLIST	146
Chapter 13. Reference	149
How to Read the CLIST Statement Syntax	149
ATTN Statement	152
CLOSEFILE Statement	153
CONTROL Statement	154
DATA-ENDDATA Sequence	156
DATA PROMPT-ENDDATA Sequence	156
DO Statement	156
END Statement	158
ERROR Statement	158
EXIT Statement	159
GETFILE Statement	160
GLOBAL Statement	160
GOTO Statement	161
IF-THEN-ELSE Sequence	162
LISTDSI Statement	162
CLIST Variables Set by LISTDSI	165
Return Codes	168
Reason Codes	168
NGLOBAL Statement	170
OPENFILE Statement	170
PROC Statement	171
PUTFILE Statement	172
READ Statement	173
READDVAL Statement	173
RETURN Statement	173
SELECT Statement	174
Simple SELECT	174
Compound SELECT	175
SET Statement	176

SYSCALL Statement	176
SYSREF Statement.	177
TERMIN and TERMING Statement	178
WRITE and WRITENR Statements	179
END Command	180
EXEC Command.	180
Appendix. Accessibility.	181
Using assistive technologies	181
Keyboard navigation of the user interface.	181
Notices	183
Programming Interface Information	185
Trademarks.	185
Bibliography	187
TSO/E Publications	187
Related Publications	187
Index	189

Figures

1. Sample CLIST Consisting of TSO/E Commands	2
2. How a CLIST Executes a Compound DO Sequence	73
3. Nested CLISTs	79
4. A CLIST Containing an Attention Routine - The ALLOCATE CLIST	103
5. An Attention Handling CLIST - The HOUSKPNG CLIST	104
6. The COPYDATA CLIST	107
7. Sample CLIST with Diagnostic CONTROL Options	110
8. Diagnostic Output from Sample CLIST	110
9. Error Messages in Diagnostic Output from Sample CLIST	110
10. The LISTER CLIST	118
11. The DELETEDS CLIST	118
12. The CALC CLIST	119
13. The CALCFTND CLIST	120
14. The SCRIPTDS CLIST	121
15. The SCRIPTN CLIST	123
16. The SCRIPTD CLIST	123
17. The OUTPUT CLIST	124
18. The SUBMITDS CLIST	125
19. The SUBMITFQ CLIST	126
20. The RUNPRICE CLIST	127
21. The TESTDYN CLIST	128
22. The COMPRESS CLIST	130
23. The CASH CLIST	132
24. The PHONE CLIST	133
25. The SPROC CLIST	135
26. The PROFILE CLIST	138
27. The Terminal Characteristics Panel Definition (XYZABC10)	140
28. The LOG/LIST Characteristics Panel Definition (XYZABC20)	141
29. The PF Keys 1-12 Panel Definition (XYZABC30)	143
30. The PF Keys 13-24 Panel Definition (XYZABC40)	145
31. The EXPAND CLIST	147

Tables

1. CLIST Statement Categories	10
2. Arithmetic, Comparative, and Logical Operators	13
3. Control Variable by Category	29
4. Modifiable Control Variables (alphabetically)	30
5. Non-modifiable Control Variables (alphabetically)	30
6. Built-in Functions	51
7. TERMIN and TERMING Statement Comparison	92
8. CLIST Statement Error Codes (Decimal)	111
9. Sample CLISTs and Their Functions	117
10. Purpose of, and Figures Containing, PROFILE CLIST and Supporting Panels	138
11. Variables Set by LISTDSI	165
12. LISTDSI Return Codes	168
13. LISTDSI Reason Codes	169

About this document

This document supports z/OS (5694-A01) and z/OS.e (5655-G52).

This document describes how to use the TSO/E CLIST language to write programs called CLISTs. You can use CLISTs to perform a wide range of programming tasks on TSO/E.

Who should use this document

This document is intended for new and experienced CLIST programmers.

If you are a new user of the CLIST language, read each chapter and try coding the examples.

If you are experienced with CLISTs, review the chapters and familiarize yourself with the organization of this document. Then you'll be able to refer to the appropriate chapter when you have a question or want to refresh your memory.

To use the CLIST language effectively, you should be familiar with TSO/E commands. Familiarity with the Interactive System Productivity Facility (ISPF) is also helpful. For information about TSO/E commands, see *z/OS TSO/E Command Reference*.

How this document is organized

- Chapter 1, "Introduction" on page 1 describes the types of functions CLISTs perform.
- Chapter 2, "Creating, Editing, and Executing CLISTs" on page 3 describes how to create and edit CLIST data sets, and how to execute CLISTs.
- Chapter 3, "Writing CLISTs - Syntax and Conventions" on page 9 describes the rules for using CLIST statements, TSO/E commands, and JCL statements in CLISTs.
- Chapter 4, "Using Symbolic Variables" on page 17 describes how to define symbolic variables and assign values to them.
- Chapter 5, "Using Control Variables" on page 27 describes how to use CLIST control variables to obtain current information about the processing environment.
- Chapter 6, "Using Built-in Functions" on page 51 describes how to use CLIST string-handling functions to process numeric data and character strings.
- Chapter 7, "Structuring CLISTs" on page 65 describes how to use CLIST statements to make decisions and loops, and how to use CLIST subprocedures and nested CLISTs.
- Chapter 8, "Communicating with the Terminal User" on page 83 describes how to write interactive CLISTs.
- Chapter 9, "Performing File I/O" on page 95 describes how to read and write records to and from files.
- Chapter 10, "Writing ATTN and ERROR Routines" on page 101 describes how to write routines that receive control when errors occur or when the user presses the attention key while a CLIST is running.
- Chapter 11, "Testing and Debugging CLISTs" on page 109 describes how to find and correct CLIST errors. This chapter includes a list of error codes and their meanings.

- Chapter 12, “Sample CLISTs” on page 117 provides sample CLISTs that perform a broad range of application tasks. Each CLIST comes with a description of the concepts that it illustrates. Generally, the more advanced CLISTs expand upon concepts introduced in the simpler examples.
- Chapter 13, “Reference” on page 149 contains complete syntax descriptions of all of the CLIST statements.

Where to find more information

Please see *z/OS Information Roadmap* for an overview of the documentation associated with z/OS, including the documentation available for z/OS TSO/E.

Accessing licensed books on the Web

z/OS licensed documentation in PDF format is available on the Internet at the IBM Resource Link Web site at:

<http://www.ibm.com/servers/resourceLink>

Licensed books are available only to customers with a z/OS license. Access to these books requires an IBM Resource Link Web userid and password, and a key code. With your z/OS order you received a memo that includes this key code.

To obtain your IBM Resource Link Web userid and password log on to:

<http://www.ibm.com/servers/resourceLink>

To register for access to the z/OS licensed books:

1. Log on to Resource Link using your Resource Link userid and password.
2. Click on **User Profiles** located on the left-hand navigation bar.
3. Click on **Access Profile**.
4. Click on **Request Access to Licensed books**.
5. Supply your key code where requested and click on the **Submit** button.

If you supplied the correct key code you will receive confirmation that your request is being processed. After your request is processed you will receive an e-mail confirmation.

Note: You cannot access the z/OS licensed books unless you have registered for access to them and received an e-mail confirmation informing you that your request has been processed.

To access the licensed books:

1. Log on to Resource Link using your Resource Link userid and password.
2. Click on **Library**.
3. Click on **zSeries**.
4. Click on **Software**.
5. Click on **z/OS**.
6. Access the licensed book by selecting the appropriate element.

Using LookAt to look up message explanations

LookAt is an online facility that allows you to look up explanations for most messages you encounter, as well as for some system abends and codes. Using LookAt to find information is faster than a conventional search because in most cases LookAt goes directly to the message explanation.

You can access LookAt from the Internet at:

<http://www.ibm.com/eserver/zseries/zos/bkserv/lookat/>

or from anywhere in z/OS where you can access a TSO/E command line (for example, TSO/E prompt, ISPF, z/OS UNIX System Services running OMVS). You can also download code from the *z/OS Collection* (SK3T-4269) and the LookAt Web site that will allow you to access LookAt from a handheld computer (Palm Pilot VIIx suggested).

To use LookAt as a TSO/E command, you must have LookAt installed on your host system. You can obtain the LookAt code for TSO/E from a disk on your *z/OS Collection* (SK3T-4269) or from the **News** section on the LookAt Web site.

Some messages have information in more than one document. For those messages, LookAt displays a list of documents in which the message appears.

Summary of changes

Summary of changes for SA22-7781-02 z/OS Version 1 Release 4

This document contains information previously presented in *z/OS TSO/E CLISTS*, SA22-7781-01, which supports z/OS TSO/E Version 1 Release 3 and subsequent releases.

The following summarizes the changes to that information.

New information

Information is added to indicate this document supports z/OS.e.

A new LISTDSI reason code was added.

This document contains terminology, maintenance, and editorial changes. Technical changes or additions to the text and illustrations are indicated by a vertical line to the left of the change.

Starting with z/OS V1R2, you may notice changes in the style and structure of some content in this document—for example, headings that use uppercase for the first letter of initial words only, and procedures that have a different look and format. The changes are ongoing improvements to the consistency and retrievability of information in our books.

Summary of changes for SA22-7781-01 z/OS Version 1 Release 3

This document contains information previously presented in *z/OS TSO/E CLISTS*, SA22-7781-00, which supports z/OS TSO/E Version 1 Release 1 and subsequent releases.

The following summarizes the changes to that information.

New information

“Considerations for Using &SYSOUTTRAP and &SYSOUTLINE” on page 47 (APAR OW48606).

An appendix with z/OS product accessibility information has been added.

Changed information

“&SYSHSM” on page 36 (APAR OW47697).

“&SYSOPSYS” on page 39 (Readers’ Comments).

This document contains terminology, maintenance, and editorial changes, including changes to improve consistency and retrievability.

Starting with z/OS V1R2, you may notice changes in the style and structure of some content in this document—for example, headings that use uppercase for the first letter of initial words only, and procedures that have a different look and format. The changes are ongoing improvements to the consistency and retrievability of information in our books.

Chapter 1. Introduction

Features of the CLIST Language	1
Categories of CLISTs	1
CLISTs That Perform Routine Tasks	1
CLISTs That Are Structured Applications	2
CLISTs That Manage Applications Written in Other Languages	2

The CLIST language enables you to work more efficiently with TSO/E. You can write programs, called CLISTs, that perform given tasks or groups of tasks. From then on, you can simply invoke the CLISTs to do those tasks.

The term *CLIST* (pronounced “sea list”) is short for *Command LIST*, because the most basic CLISTs are lists of TSO/E commands. When you invoke such a CLIST, it issues the TSO/E commands in sequence.

Besides issuing TSO/E commands, CLISTs can perform more complex programming tasks. The CLIST language includes the programming tools you need to write extensive, structured applications. CLISTs can perform any number of complex tasks, from displaying a series of full-screen panels to managing programs written in other languages.

The CLIST language is an interpretive language. Like programs in other high-level interpretive languages, CLISTs are easy to write and test. You don’t have to compile and link-edit them. To test a CLIST, you execute it, correct any errors, and re-execute it.

The CLIST language is one of two command languages available in TSO/E. For information about the other command language, REXX, see *z/OS TSO/E REXX User’s Guide*, and *z/OS TSO/E REXX Reference*.

Features of the CLIST Language

The CLIST language provides a wide range of programming functions. Its features include:

- An extensive set of arithmetic and logical operators for processing numeric data
- String-handling functions for processing character data
- CLIST statements that let you structure your programs, perform I/O, define and modify variables, and handle errors and attention interrupts

Categories of CLISTs

A CLIST can perform a wide range of tasks. Three general categories of CLISTs are:

- CLISTs that perform routine tasks
- CLISTs that are structured applications
- CLISTs that manage applications written in other languages

CLISTs That Perform Routine Tasks

As a user of TSO/E, you probably perform certain tasks on a regular basis. These tasks may involve entering TSO/E commands to check on the status of data sets, to allocate data sets for particular programs, and to print files.

Categories of CLISTs

You can write CLISTs that significantly reduce the amount of time that you have to spend on these routine tasks. By grouping together in a CLIST the instructions required to complete a task, you reduce the time, number of keystrokes, and errors involved in performing the task; thus, you increase your productivity. Such a CLIST can consist of TSO/E commands only, or a combination of TSO/E commands, JCL statements, or CLIST statements.

Figure 1 is an example of a CLIST that consists of TSO/E commands only.

```
allocate file(ABC) dataset(name1)
allocate file(DEF) dataset(name2)
call (prog1)
free file(ABC DEF)
```

Figure 1. Sample CLIST Consisting of TSO/E Commands

The CLIST in Figure 1 issues TSO/E commands to allocate files for a program, call the program, and free the files when the program is finished. Whenever you wanted to perform these related tasks, you could simply execute the CLIST instead of retyping the commands.

If tasks require specific input from a user, you can obtain the input in a CLIST by using CLIST statements or TSO/E commands to prompt the user for the input.

CLISTs That Are Structured Applications

The CLIST language includes the basic tools you need to write complete, structured applications. Any CLIST can invoke another CLIST, which is referred to as a nested CLIST. CLISTs can also contain separate routines called subprocedures. Nested CLISTs and subprocedures let you separate your CLISTs into logical units and put common functions in a single location. Specific CLIST statements let you:

- Define common data for subprocedures and nested CLISTs
- Restrict data to certain subprocedures and CLISTs
- Pass specific data to a subprocedure or nested CLIST

For interactive applications, CLISTs can issue commands of the Interactive System Productivity Facility (ISPF) to display full-screen panels. Conversely, ISPF panels can invoke CLISTs, based on input that a user types on the panel. When the user changes a value on a panel, the change applies to the value in the CLIST that displayed the panel. With ISPF, CLISTs can manage extensive panel-driven dialogs.

CLISTs That Manage Applications Written in Other Languages

You might have access to applications that are written in other programming languages. However, the interfaces to these applications might not be easy to use or remember. Rather than write new applications, you can write CLISTs that provide easy-to-use interfaces between the user and such applications.

A CLIST can send messages to, and receive messages from, the terminal to determine what the user wants to do. Then, based on this information, the CLIST can set up the environment and issue the commands required to invoke the program that performs the requested tasks.

Chapter 2. Creating, Editing, and Executing CLISTS

CLIST Data Sets and Libraries	3
Creating and Editing CLIST Data Sets	3
CLIST Data Set Attributes	4
Considerations for Copying CLIST Data Sets	4
Executing CLISTS	5
Passing Parameters to CLISTS	6
Allocating CLIST Libraries for Implicit Execution	6
Specifying Alternative CLIST Libraries with the ALTLIB Command	7
Using the ALTLIB Command	7
Using ALTLIB with ISPF	7
Stacking ALTLIB Requests	8
Examples of the ALTLIB Command	8

CLIST Data Sets and Libraries

CLISTS reside in either sequential or partitioned data sets (PDSs). A sequential CLIST data set consists of only one CLIST, while a PDS can contain one or more CLISTS. In a PDS, each CLIST is a member and has a unique member name. When a PDS consists entirely of CLISTS, it is called a CLIST library.

CLIST libraries make CLISTS easy to maintain and execute. Your installation can keep commonly used CLISTS in a system CLIST library, and you can keep your own CLISTS in a private CLIST library. If you allocate a CLIST library to the file SYSPROC, or specify the library on the ALTLIB command, you can execute the CLISTS *implicitly* by simply typing their member names.

Implicit execution frees you from having to code the name of the CLIST library on an EXEC command. Besides saving keystrokes, implicit execution lets you keep different versions of a CLIST in different libraries and control which version executes at a given time. For more information, see “Allocating CLIST Libraries for Implicit Execution” on page 6.

CLISTS invoked implicitly, and command processors invoked from CLISTS, should not have names equal to reserved CLIST words. If name conflicts can not be avoided, consider using the &STR built-in function to solve the problem. See “Defining Character Data - &STR” on page 55. For example, in the case of the SELECT subcommand of the RACFRW command, you could specify the subcommand name as follows, to avoid confusion with the CLIST SELECT statement:

```
&STR(SELECT) VIOLATIONS
```

Creating and Editing CLIST Data Sets

Before coding your first CLIST, you must create a CLIST data set. There are two ways to create and edit a CLIST data set:

1. Using options 3 (UTILITIES) and 2 (EDIT) of ISPF/PDF:
 - a. Create a data set using the allocate panel in ISPF (usually option 3.2 on the primary menu).
 - To simplify execution, specify CLIST as the data set type.

Creating and Editing CLIST Data Sets

- To create a data set with the same attributes as another, such as a system CLIST library, use option 3.2 to view the attributes of the existing data set and then allocate the new data set.
- b. Code your CLIST in the full-screen environment using the ISPF/PDF editor (usually option 2).
- c. Modify the CLIST by making corrections directly to the data on the screen.

For more information about creating and editing data sets under ISPF/PDF, see *z/OS TSO/E Primer*.

2. Using the TSO/E EDIT command and its subcommands (this method includes option 6 of ISPF/PDF.):
 - a. Include the CLIST keyword on the EDIT command.
 - b. Enter and save your CLIST statements, TSO/E commands, and TSO/E subcommands.
 - c. Use subcommands of EDIT to modify the CLIST.

CLISTs created with the EDIT command cannot contain characters of the double-byte character set (DBCS).

More information about creating and editing data sets under TSO/E can be found in *z/OS TSO/E Command Reference*.

CLIST Data Set Attributes

If a CLIST data set is created by one of the previously described methods, and the CLIST keyword is specified on the EDIT command, the data set will be assigned the following default attributes (provided that your installation has not changed the default values):

- A variable-length record format
If you specify a LINE value on the EDIT command, the data set will be of a fixed-length record format in the specified length.
- A logical record size of 255 characters
- A block size of 3120 bytes
- Line numbers are contained in the last eight bytes of all fixed-length records and in the first eight bytes of all variable-length records
- All input data and modified data are converted to uppercase characters.

Your installation may have changed these default attributes and may have established CLIST data set conventions to ease data set tasks.

If you concatenate CLIST data sets, specify the same RECFM and LRECL values for these data sets.

For a complete description of edited data sets see, the EDIT command in *z/OS TSO/E Command Reference*. For a discussion of the formats and characteristics of the RECFM subparameter of the DCB parameter, see *z/OS MVS JCL Reference*. If you want to obtain information about a data set for use in CLIST variables, see "LISTDSI Statement" on page 162.

Considerations for Copying CLIST Data Sets

When creating and editing CLISTs, you might copy an existing CLIST data set into a new data set. If you do so under ISPF/PDF, be aware of the record formats of the data sets. Variable-blocked data sets might contain line numbers in columns 1-8

that do not normally appear when you edit the data sets. If you copy a variable-blocked data set into a fixed-blocked data set, the line numbers are copied as part of the data. This data must then be removed. To find out if a data set contains line numbers, use the ISPF EDIT command PROFILE.

If you copy a fixed-blocked data set with line numbers into a variable-blocked data set, the system copies sequence numbers from columns 73-80 into the variable-blocked data set. This data must also be removed. For information about how to remove the sequence numbers from a variable-blocked data set, see *z/OS ISPF Edit and Edit Macros*.

Executing CLISTS

To execute a CLIST, use the EXEC command. From an ISPF command line, type TSO in front of the command. In TSO/E EDIT or TEST mode, use the EXEC subcommand as you would use the EXEC command. (CLISTS executed under EDIT or TEST can issue only EDIT or TEST subcommands and CLIST statements, but you can use the END subcommand in a CLIST to end EDIT or TEST mode and allow the CLIST to issue TSO/E commands.)

The EXEC command (or subcommand) has two forms:

1. **Explicit form:** Enter “exec” or “ex” followed by the data set name and the optional CLIST operand. By default, the EXEC command assumes that the data set type is CLIST and automatically suffixes all specified names with **.CLIST**, unless the name is in quotes. For example:

- If a CLIST, LISTPGM, is a member of a PDS named PREFIX.CLISTLIB.CLIST, enter:

```
{exec} clistlib(listpgm) [CLIST]
{ex }
```

- If a CLIST, LISTPGM, is a member of a PDS named PREFIX.CLIST, enter:

```
{exec} (listpgm) [CLIST]
{ex }
```

- If the CLIST is in a sequential data set named PREFIX.LISTPGM.CLIST, enter:

```
{exec} (listpgm) [CLIST]
{ex }
```

- If the CLIST is in a sequential data set named PREFIX.LISTPGM, enter:

```
{exec} 'prefix.listpgm' [CLIST]
{ex }
```

If the EXEC command is used to execute a CLIST in a sequential data set, but the data set is found to be a partitioned one, it will assume a member TEMPNAME. The system will notify you if this member is not found, otherwise it will execute it.

2. **Implicit form:** Enter only the name of the CLIST, optionally preceded by a percent sign (%). The CLIST must be a member of a PDS allocated to the file SYSPROC, or an alternative library specified with the ALTLIB command. The two implicit forms are as follows:

- a. Enter only the member name, for example:

```
listpgm
```

When you use this form, TSO/E first searches command libraries to ensure that the name you entered is not a TSO/E command, then searches CLIST libraries:

Executing CLISTS

- Specified with the ALTLIB command or
 - Allocated to the SYSPROC file
- b. Enter the member name prefixed with a percent sign (%), for example:
- ```
%listpgm
```

When you use this form, called the extended implicit form, TSO/E searches only the ALTLIB or SYSPROC libraries for the name, thus reducing the amount of search time.

For information about preparing a CLIST for implicit execution, see “Allocating CLIST Libraries for Implicit Execution”.

You can execute a CLIST in either the foreground (from your terminal) or in the background (submit it as a batch job). You can also execute a CLIST from another CLIST (using the EXEC command) or from a program. To invoke a CLIST from a program, use the TSO/E service facility described in *z/OS TSO/E Programming Services*.

## Passing Parameters to CLISTS

You can pass parameters to a CLIST when you execute it. Parameters are variable input that may change from one execution to the next. To receive parameters, a CLIST must begin with a PROC statement that assigns the parameters to variables. “Using the PROC Statement” on page 20 explains how to code a PROC statement to receive parameters.

To pass parameters to a CLIST, include them on the EXEC command or subcommand as follows:

- For the explicit form, pass parameters in single quotes:  

```
EX clistname 'parm1 parm2'
```
- For the implicit or extended implicit form, omit the quotes:  

```
%clistname parm1 parm2
```

For more information about the types of parameters you can pass, and how to use them in a CLIST, see “Using the PROC Statement” on page 20.

For a complete syntactical definition of the EXEC command, including special considerations for passing parameters that contain single quotes, see Chapter 13, “Reference” on page 149.

---

## Allocating CLIST Libraries for Implicit Execution

After you have written CLISTS and executed them to make sure they run correctly, you can allocate them to special files to make them easier to execute.

When CLISTS are members of a partitioned data set (PDS) allocated to a special file, users and applications can execute the CLISTS implicitly by simply invoking the member names. How you can allocate CLIST libraries for implicit execution depends on the feature of TSO/E installed on your system.

The ALTLIB command gives you more flexibility in specifying CLIST libraries for implicit execution. With ALTLIB, a user or ISPF application can easily activate and deactivate CLIST libraries for implicit execution as the need arises. This flexibility can result in less search time when fewer CLISTS are activated for implicit execution at the same time.

## Allocating CLIST Libraries for Implicit Execution

In addition to CLISTS, the ALTLIB command lets you specify libraries of REXX execs for implicit execution. For information about using ALTLIB with REXX execs, see *z/OS TSO/E REXX User's Guide*.

### Specifying Alternative CLIST Libraries with the ALTLIB Command

The ALTLIB command lets you specify *alternative libraries* to contain implicitly executable CLISTS. You can specify alternative libraries on the user, application, and system levels.

- The *user level* includes CLIST libraries allocated to the file SYSUPROC. During implicit execution, these libraries are searched first.
- The *application level* includes CLIST libraries specified on the ALTLIB command by data set or file name. During implicit execution, these libraries are searched after user libraries.
- The *system level* includes CLIST libraries allocated to file SYSPROC. During implicit execution, these libraries are searched after user or application libraries.

#### Using the ALTLIB Command

The ALTLIB command offers several functions, which you specify using the following operands:

##### ACTIVATE

allows implicit execution of CLISTS in a library or libraries on the specified level(s), in the order specified.

##### DEACTIVATE

excludes the specified level(s) from the search order.

##### DISPLAY

displays the current order in which CLIST libraries are searched for implicit execution.

##### RESET

resets searching to the system level only, for CLISTS and REXX execs.

For complete information about the syntax of the ALTLIB command, see *z/OS TSO/E Command Reference*.

##### Notes:

1. With ALTLIB, data sets concatenated to each of the levels can have differing characteristics (logical record length and record format), but the data sets within the same level must have the same characteristics.
2. At the application and system levels, ALTLIB uses the virtual lookaside facility (VLF) to provide potential increases in library search speed.

#### Using ALTLIB with ISPF

ALTLIB works the same in line mode TSO/E and in ISPF. However, if you use ALTLIB under line mode TSO/E and start ISPF, the alternative libraries you specified under line mode TSO/E are unavailable until ISPF ends.

Application-level libraries that you define while running an ISPF application are in effect only while that application has control. When the application completes, the original application-level libraries are automatically reactivated.

Under ISPF, you can pass the alternative library definitions from application to application by using ISPEXEC SELECT with the PASSLIB operand. For example, to pass ALTLIB definitions to a new ISPF application (ABC), code:

```
ISPEXEC SELECT NEWAPPL(ABC) PASSLIB
```

## Allocating CLIST Libraries for Implicit Execution

The PASSLIB operand passes the ALTLIB definitions to the invoked application. When the invoked application completes and the invoking application regains control, the ALTLIB definitions that were passed take effect again, regardless of whether the invoked application changed them. If you omit the PASSLIB operand, ALTLIB definitions are not passed to the invoked application.

For more information about writing ISPF applications, see *z/OS ISPF Services Guide*.

### Stacking ALTLIB Requests

On the application level, you can stack up to eight activate requests with the top, or current, request active.

## Examples of the ALTLIB Command

In the following example, an application issues the ALTLIB command to allow implicit execution of CLISTs in the data set NEW.CLIB, to be searched ahead of SYSPROC:

```
ALTLIB ACTIVATE APPLICATION(CLIST) DATASET(new.clib)
```

The application could also allow searching for any private CLISTs that the user has allocated to the file SYSUPROC, with the following command:

```
ALTLIB ACTIVATE USER(CLIST)
```

To display the active libraries in their current search order, use the DISPLAY operand as follows:

```
ALTLIB DISPLAY
```

To deactivate searching for a certain level, use the DEACTIVATE operand; for example, to deactivate searching for CLISTs on the system level (those allocated to SYSPROC), issue:

```
ALTLIB DEACTIVATE SYSTEM(CLIST)
```

And, to reset CLIST and REXX exec searching back to the system level, issue:

```
ALTLIB RESET
```

For more information about the search order EXEC uses for CLISTs and REXX execs, see *z/OS TSO/E Command Reference*.

---

## Chapter 3. Writing CLISTs - Syntax and Conventions

|                                                |    |
|------------------------------------------------|----|
| Overview of CLIST Statements . . . . .         | 9  |
| Syntax Rules . . . . .                         | 10 |
| Delimiters . . . . .                           | 10 |
| Continuation Symbols . . . . .                 | 10 |
| Capitalization . . . . .                       | 10 |
| Formatting . . . . .                           | 11 |
| Length . . . . .                               | 11 |
| Labels . . . . .                               | 11 |
| Comments . . . . .                             | 11 |
| Characters Supported in CLISTs . . . . .       | 12 |
| TSO/E Commands and JCL Statements . . . . .    | 12 |
| TSO/E Commands . . . . .                       | 12 |
| JCL Statements . . . . .                       | 12 |
| Operators and Expressions . . . . .            | 13 |
| Order of Evaluations . . . . .                 | 14 |
| Valid Numeric Ranges . . . . .                 | 15 |
| The Double-Byte Character Set (DBCS) . . . . . | 15 |
| DBCS Delimiters . . . . .                      | 15 |
| DBCS Restrictions . . . . .                    | 15 |

This chapter provides an overview of CLIST statements and describes how to use the following:

- Syntax rules of the CLIST language
- TSO/E commands and JCL statements in CLISTs
- CLIST operators and expressions
- The double-byte character set (DBCS) in CLISTs

When you are familiar with the contents of this chapter, read the following chapters for information about how to use variables and terminal input in CLISTs.

---

### Overview of CLIST Statements

CLIST statements set controls, assign values to variables, monitor the conditions under which CLISTs execute, and perform I/O. CLIST statements execute in both the command and subcommand environment (under the TSO/E EXEC command and the EXEC subcommand of TSO/E EDIT). They fall into the categories shown in Table 1 on page 10.

## Overview of CLIST Statements

Table 1. CLIST Statement Categories

| Control                                                                                                                                                           | Assignment                         | Conditional                  | I/O                                         |
|-------------------------------------------------------------------------------------------------------------------------------------------------------------------|------------------------------------|------------------------------|---------------------------------------------|
| ATTN<br>CONTROL<br>DATA-ENDDATA<br>DATA-PROMPT<br>ERROR<br>EXIT<br>GLOBAL<br>GOTO<br>NGLOBAL<br>PROC<br>RETURN<br>SYSCALL<br>SYSREF<br>TERMIN<br>WRITE<br>WRITENR | READ<br>READDVAL<br>SET<br>LISTDSI | DO<br>IF-THEN-ELSE<br>SELECT | CLOSEFILE<br>GETFILE<br>OPENFILE<br>PUTFILE |

Subsequent topics in this document describe all of the statements in detail.

**Note:** In addition to these CLIST statements, IBM provides an installation exit that lets your installation add its own CLIST statements. For information about this exit, see *z/OS TSO/E Customization*.

---

## Syntax Rules

This section describes the syntax rules for CLIST statements relative to those for TSO/E commands.

## Delimiters

Most CLIST statements have operands. Operands are variables or data that provide information to be used in processing the statement. Include one or more blanks between a CLIST statement and its first operand. Also, separate operands from each other by one or more blanks, a comma, or tabs.

## Continuation Symbols

Line continuation symbols are the same as for TSO/E commands. If used, the continuation symbol must be the last non-blank character on the line. A hyphen (-) indicates that leading blanks in the next line are not ignored. A plus sign (+) indicates that leading blanks in the next line are ignored. For example, the following command executes successfully:

```
alloc da(jc1.cnt1) shr-
 reuse file(input)
```

However, if you substitute a plus sign for the hyphen in this example, the command fails because, when the lines are joined logically, there is no blank between the end of the **shr** keyword and the beginning of the **reuse** keyword. You would have to insert a blank before the plus sign for correct execution.

## Capitalization

All CLIST statement names must be capitalized. If you use lowercase letters for CLIST statement names, the CLIST fails. Capitalization of CLIST variable names

and built-in function names is optional. Capitalization of TSO/E commands and subcommands in a CLIST is also optional.

## Formatting

You can use blank lines in a CLIST as a formatting aid, to separate parts of the CLIST and make the CLIST easier to read. Blank lines do not affect CLIST processing, except that a blank line after a continuation symbol ends continuation, unless the blank line is also continued.

## Length

The maximum length of a CLIST statement is 32756 bytes.

## Labels

You can prefix CLIST statements and TSO/E commands with a label. Other statements can use the label to pass control to the statement or command. Labels can consist of 1-31 alphanumeric characters (A-Z, 0-9, #, \$, @, \_) beginning with an alphabetic character (A-Z). The label can appear on the same line as the statement or command, or on the preceding line. A colon must immediately follow the label name. For example,

```
label: IF A= ...
```

or

```
label: +
 IF A= ...
```

## Comments

You can include a comment:

- On a line by itself
- Before, in the middle of, or after a CLIST statement or TSO/E command.

You define a comment by coding a slash-asterisk (comment delimiter) followed by the descriptive text. If you include the comment before or in the middle of a CLIST statement or TSO/E command, you must end the comment with a closing comment delimiter (asterisk-slash). The following example shows a comment included before a CLIST statement:

```
/*get return code */ SET RC = &LASTCC
```

If you include a comment after a CLIST statement or TSO/E command, or on a line by itself, the closing comment delimiter is not needed, as shown in the following example:

```
alloc file(in) da(accounts.data) shr /* Input data set
```

If a comment appears after a CLIST statement or TSO/E command that continues on the following line, the comment must end with a closing comment delimiter and the continuation character must appear *after* the comment delimiter, as shown in the following example:

```
IF &LASTCC ^= 0 THEN /* error occurred */ +
 DO ...
```

CLISTs can begin with a comment, but the first line of a CLIST must not be a comment containing the acronym REXX; if the first line contains "REXX" in any

## Syntax Rules

position, the EXEC command attempts to process the CLIST as a REXX exec. Note that comments can be in both uppercase and lowercase letters. Comments are unaffected by CLIST processing.

## Characters Supported in CLISTs

CLIST statements can process all data characters represented by hexadecimal codes 40 through FF. It should be noted that CLISTs translate lowercase letters to uppercase letters, unless controlled by NOCAPS or ASIS, and translate lowercase numbers (B0-B9) to standard numbers (F0-F9). CLISTs also support the following control characters:

| Hexadecimal code | Control character                            |
|------------------|----------------------------------------------|
| 05               | HT (horizontal tab)                          |
| 0E               | Shift Out (starting delimiter for DBCS data) |
| 0F               | Shift In (ending delimiter for DBCS data)    |
| 14               | RES (restore)                                |
| 16               | BS (backscore)                               |
| 17               | IL (idle)                                    |
| 24               | BYP (bypass)                                 |
| 25               | LF (line feed).                              |

All other hexadecimal codes from 00 to 3F are reserved for internal processing and can cause errors if they appear in CLIST data. The use of I/O statements to process data sets containing these codes is not supported. For example, OBJ and LOAD type data sets contain unsupported characters and must not be used for CLIST I/O.

**Note:** Some characters supported in CLIST, such as { (X'C0') and } (X'D0'), cannot be written to the terminal because of TSO/E output processing. To write such characters to a terminal, create TSO/VTAM translate tables and invoke the tables with the TSO/E TERMINAL command. For more information about creating translate tables, see *z/OS TSO/E Customization*. For CLISTs executed under the TSO/E Session Manager, these restrictions do not apply.

---

## TSO/E Commands and JCL Statements

You can include TSO/E commands and subcommands, and JCL statements in a CLIST as needed.

### TSO/E Commands

You can include TSO/E commands and subcommands (and user-written commands and subcommands) in a CLIST at any point where the specific functions (for example, allocate, free, and so on) are required. For certain applications, a CLIST might consist entirely of commands and subcommands. You can also substitute CLIST variables as operands in commands and subcommands, or as commands themselves. For more information about CLIST variables, see Chapter 4, "Using Symbolic Variables" on page 17.

### JCL Statements

From a CLIST, you might want to submit a jobstream for execution. In the CLIST, you can include the required JCL statements (EXEC, DD, and so on). However,



when you include the following JCL statements in a CLIST, you must use a particular CLIST function to prevent the CLIST from modifying the statements and causing subsequent JCL errors.

1. Statements following the SYSIN statement - use the &STR built-in function to preserve leading blanks and statements that have the same names as CLIST statements.
2. A statement containing a single ampersand (&) or a double ampersand (&&) - use the &SYSNSUB or &NRSTR built-in functions.
3. JCL comments - use the &STR built-in function. Because CLIST processing detects the JCL comment as a comment for the CLIST, you must set a variable equal to &STR(/\*) and use this variable in place of the JCL comment.
4. JCL imbedded in a CLIST can use the SUBMIT \* form of the SUBMIT command; however, *all* JCL is converted to uppercase. If JCL conversion to uppercase is inappropriate or undesirable, use the SUBMIT (dataset\_name) form of the SUBMIT command. For a description of the SUBMIT command, see *z/OS TSO/E Command Reference*.

Examples of using these built-in functions with JCL are provided in Chapter 6, "Using Built-in Functions" on page 51 and in Figure 18 on page 125.

## Operators and Expressions

Operators cause a CLIST to perform evaluations on data; the data can be numeric or character, or can be a variable or a built-in function. Operators fall into three categories: arithmetic, comparative, and logical, as shown in Table 2.

- Arithmetic operators perform integer arithmetic on numeric operands. The operators connect integers, variables, or built-in functions to form expressions, such as 4-2.
- Comparative operators perform comparisons between two expressions, to form comparative expressions, such as 4-2=3. The "=" is a comparative operator. The comparison produces a true or false condition. Comparative expressions are often used to determine conditional branching within a CLIST.
- Logical operators perform a logical comparison between the results of two comparative expressions, to form logical expressions, such as &A=4 AND &B=&C. The 'AND' is a logical operator.  
Logical expressions produce true or false conditions. Logical expressions are often used to determine conditional branching within a CLIST.

In Table 2, if more than one accepted value exists for an operator, the values are separated by commas.

Table 2. Arithmetic, Comparative, and Logical Operators

|            | For the function:                                                                                                              | Enter:                                                       |
|------------|--------------------------------------------------------------------------------------------------------------------------------|--------------------------------------------------------------|
| Arithmetic | Addition<br>Subtraction<br>Multiplication<br>Division<br>Exponentiation<br>Remainder<br>Prioritization the order of evaluation | +<br>-<br>*<br>/<br>** (See note 1)<br>//<br>() (See note 2) |

## Operators and Expressions

Table 2. Arithmetic, Comparative, and Logical Operators (continued)

|                                                                                                                                                                                                                                                             | For the function:                                                                                          | Enter:                                                        |
|-------------------------------------------------------------------------------------------------------------------------------------------------------------------------------------------------------------------------------------------------------------|------------------------------------------------------------------------------------------------------------|---------------------------------------------------------------|
| Comparative                                                                                                                                                                                                                                                 | Equal<br>Not equal<br>Less than<br>Greater than<br>Less than or equal<br>Not greater than<br>Not less than | =,EQ<br>≠,NE<br><,LT<br>>,GT<br>≤,LE<br>≥,GE<br>↯,NG<br>↯<,NL |
| Logical                                                                                                                                                                                                                                                     | And<br>Or                                                                                                  | AND,&&<br>OR,                                                 |
| <b>Notes:</b> <ol style="list-style-type: none"> <li>1. Negative exponents are handled as exponents of zero, thus the result is always set to 1.</li> <li>2. Put parentheses around operations to give them priority in the order of evaluation.</li> </ol> |                                                                                                            |                                                               |

CLISTs try to perform evaluation wherever an operator is found, including the equal sign (=) in assignment statements. If you want CLISTs to treat operators as character data instead, use the &STR built-in function. For more information, see “Defining Character Data - &STR” on page 55.

## Order of Evaluations

A CLIST evaluates operations in the following default order. (Wherever more than one operation is listed below, the CLIST performs the operations sequentially, left to right in the order in which they appear on the CLIST statement.)

1. Exponentiation remainder
2. Multiplication, division
3. Addition, subtraction
4. Comparative operators
5. Logical AND
6. Logical OR

You can override the default order by placing parentheses around the operations you want executed first. For example, without any parentheses, the following example performs multiplication, division, then addition. The statement sets *X* to the value 24.

```
SET X = 4+5*8/2
```

By placing parentheses around *4+5*, you indicate to the CLIST that it should perform addition first and then proceed with the default order (multiplication, then division). The following statement sets *X* to the value 36.

```
SET X = (4+5)*8/2
```

You can place parentheses around expressions that are themselves enclosed in parentheses. This process is called nesting parenthesized expressions. The CLIST evaluates the deepest level of nesting first and proceeds outward until all nesting has been evaluated. In the following example, *X* is set to the value 7.

```
SET X=((1+4)*2+4)/2
```

The parentheses around  $1+4$  indicate that the CLIST should add these numbers before performing multiplication. The parentheses around the compound expression to the left of the division operator indicate that the CLIST should evaluate the compound expression before performing division.

In the preceding example, if you omit the outer-level parentheses, the CLIST performs division as the third operation ( $4/2$ ) and sets  $X$  to the value 12:

```
SET X=(1+4)*2+4/2
```

### Valid Numeric Ranges

The values of numeric variables must be integers in the range from  $-2,147,483,647$  ( $-2^{31}+1$ ) to  $+2,147,483,647$  ( $+2^{31}-1$ ).

A CLIST terminates and issues an error message in the following situations:

- You explicitly code a value outside the valid range.
- The evaluation of an expression produces an intermediate or final value outside the valid range.

---

### The Double-Byte Character Set (DBCS)

The CLIST language allows data to contain characters of the double-byte character set. The double-byte character set (DBCS) is used in national languages such as Japanese and Korean which have more than 256 characters, the maximum number that can be represented with one byte of data. As the name implies, double-byte characters are each composed of two bytes, allowing a vastly increased number of characters.

### DBCS Delimiters

The CLIST language uses the hexadecimal codes  $X'0E'$  and  $X'0F'$  to distinguish double-byte characters from EBCDIC characters. The hexadecimal code  $X'0E'$  indicates the beginning of a string of DBCS characters, and the code  $X'0F'$  indicates the end of a DBCS string. Properly delimited DBCS character strings can be passed as character data in CLIST variables, in comments, and in the operands of CLIST statements.

This document commonly refers to the beginning and ending DBCS delimiters as *shift-out* and *shift-in* characters, respectively. In examples, this document uses the convention  $\langle d1d2 \rangle$  to represent DBCS strings enclosed in their shift-out and shift-in characters, where  $d1$  and  $d2$  each represent a DBCS character,  $\langle$  represents  $X'0E'$ , and  $\rangle$  represents  $X'0F'$ .

When DBCS strings are joined by continuation symbols, their contiguous shift-in and shift-out characters are removed to create a single DBCS string. For example:

```
SET A = ABC<d1d2> +
 <d3d4>DEF /* result: &A = ABC<d1d2d3d4>DEF
```

### DBCS Restrictions

The following restrictions apply to DBCS data in CLISTs:

- DBCS data cannot appear in any names, including the names of variables, functions, statements, data sets, or labels.
- DBCS data cannot be used in variables or operands where numeric data is expected, nor in any arithmetic operations.

## Double-Byte Character Set (DBCS)

This document lists further DBCS considerations and restrictions wherever they apply.

Two CLIST built-in functions, &SYSONEBYTE and &SYSTWOBYTE, convert data between the DBCS and EBCDIC character sets. These functions are described in Chapter 6, "Using Built-in Functions" on page 51.

---

## Chapter 4. Using Symbolic Variables

|                                                                    |    |
|--------------------------------------------------------------------|----|
| What is a Symbolic Variable? . . . . .                             | 17 |
| Valid Names of Variables . . . . .                                 | 18 |
| Valid Values of Variables . . . . .                                | 18 |
| Defining Symbolic Variables and Assigning Values to Them . . . . . | 19 |
| Using the SET Statement . . . . .                                  | 19 |
| Using the READ Statement . . . . .                                 | 19 |
| Using the PROC Statement . . . . .                                 | 20 |
| Passing Parameters to a PROC Statement . . . . .                   | 20 |
| Using PROC with Positional Parameters . . . . .                    | 20 |
| Using PROC with Keyword Parameters . . . . .                       | 20 |
| Keywords with Values . . . . .                                     | 20 |
| Keywords without Values . . . . .                                  | 21 |
| Using PROC with both Positional and Keyword Parameters . . . . .   | 21 |
| Examples . . . . .                                                 | 22 |
| More Advanced Uses of Variables . . . . .                          | 22 |
| Combining Symbolic Variables . . . . .                             | 23 |
| Using a Variable to Preserve Leading Spaces in a CLIST . . . . .   | 23 |
| Nesting Symbolic Variables . . . . .                               | 24 |
| Combining Nested Variables with Character Strings . . . . .        | 24 |
| Substitution of Nested Variables . . . . .                         | 25 |
| Combining Variables Containing DBCS Data . . . . .                 | 25 |

The CLIST language includes several types of variables. This chapter describes how to use symbolic CLIST variables. Later chapters discuss other types of variables, including control variables and variables set by CLIST built-in functions.

---

### What is a Symbolic Variable?

A symbolic variable is a string of characters that you define as a symbol. Because the variable is a symbol, you can assign different values to it at different times. By assigning different values, you can do the same processing with different data.

For example, you could use the SET statement to assign different values to a symbolic variable named PAY\_RAISE:

```
SET PAY_RAISE = 20 /* Set the value of PAY_RAISE equal to 20
```

or

```
SET PAY_RAISE = 30 /* Set the value of PAY_RAISE equal to 30
```

You could use those different values of PAY\_RAISE in the following equation, to calculate your total annual raise based on various weekly raises:

```
SET ANNUAL_RAISE = &PAY_RAISE * 52
```

In CLISTs, the ampersand (&) means “the value of.” In the example above, the CLIST multiplies the value of PAY\_RAISE (20 or 30) by 52 and assigns the resulting value to another variable, ANNUAL\_RAISE. (In a SET statement, the ampersand is required on variables to the right of the equal sign, and is optional on variables to the left of the equal sign.)

When you execute a CLIST, it scans each line and replaces the symbolic variables with their actual values. This process is called symbolic substitution.

## What is a Symbolic Variable?

In a CLIST, you can use symbolic variables to include variable data on TSO/E commands and subcommands, on JCL statements, and on many of the CLIST statements.

## Valid Names of Variables

You can define symbolic variables with meaningful names. Meaningful variable names, like PAY\_RAISE, describe the contents of the variable and make CLISTs easy to read and maintain. Note that an ampersand (&) is not part of a variable name; it simply tells the CLIST to use the value of the variable. Follow these rules when naming a symbolic variable:

1. The first character must be one of the following: A-Z, (a-z), \_, #, \$, @.

**Note:** The system recognizes the following hexadecimal codes for these characters: \_ (X'6D'), # (X'7B'), \$ (X'5B'), @ (X'7C'). In countries other than the U.S., these characters on a keyboard might generate different hexadecimal codes and cause an error. For example, in some countries the \$ character might generate a X'4A'.

2. The remaining characters can be any of the above, and 0 through 9.
3. The variable name can be up to 252 characters in length (not counting the ampersand).
4. Variable names must not match the character equivalents of CLIST operators, such as "EQ" and "NE" (see Table 2 on page 13 for a list).
5. Special rules apply to the PROC statement. On PROC statements:
  - All variables must begin with A-Z, and be in uppercase only.
  - Names of keyword variables cannot contain the underscore (\_), or be longer than 31 characters. For more information, see "Using the PROC Statement" on page 20.
6. If variables are used on ISPF panels, they cannot exceed eight characters in length.
7. Do not use the names of *statements or their keywords* as variable names. This may cause unexpected results if used in a conditional statement, as in the following sequence:

```
SET WHILE = &STR(ABC)
DO UNTIL &WHILE = &STR(ABC) WHILE (&COUNT<5)
 SET &COUNT = &COUNT + 1
END
```

The results are also unpredictable if a keyword is used within a string, as in the following:

```
SET COUNT = 0
SET VAR = ABC
DO UNTIL &VAR = &SUBSTR(3:3,WHILE) WHILE &COUNT < 5
 SET COUNT = &COUNT + 1
END
```

## Valid Values of Variables

The values of CLIST variables can generally include any characters you can enter on a keyboard. See "Characters Supported in CLISTs" on page 12 for information on special characters.

Values of symbolic variables can be up to 32756 bytes long, minus the length of the CLIST statement that assigns the value. For example, if the assignment statement is six bytes long (SET A=), the value can contain 32750 bytes.

---

## Defining Symbolic Variables and Assigning Values to Them

There are several ways to define symbolic variables and assign values to them in a CLIST. Here are some basic methods:

- Use the SET statement to define variables and give them specific values.
- Use the READ statement to define variables and get their values from a user.
- Use the PROC statement to define variables and get their values from parameters passed to the CLIST.

The previous statements define variables explicitly. You can also define a variable implicitly by referring to it in a CLIST statement before you explicitly define it. The CLIST assigns a null value to such a variable.

### Using the SET Statement

You can use the SET statement to define a symbolic variable and assign a value to it. For example, to assign the character string JOHN to the variable NAME, code:

```
SET NAME=JOHN
```

The variable NAME *contains* the value JOHN.

You can also use the SET statement to assign an initial value to a variable, then increase or decrease the value as necessary. For example, to control a loop you can initialize a counter:

```
SET COUNTER = 1
```

For each execution of the loop, you can increment the counter:

```
SET COUNTER = &COUNTER + 1
```

In the SET statement, the ampersand is required when a variable appears in the expression on the right side of the equal sign, but is optional when a variable appears on the left-hand side of the equal sign.

In addition to symbolic variables, you can also use CLIST control variables and built-in functions in SET statements. For information about control variables and built-in functions, see Chapter 5, “Using Control Variables” on page 27 and Chapter 6, “Using Built-in Functions” on page 51.

### Using the READ Statement

You can use the READ statement to define a variable and give it a value provided by the CLIST user. To prompt the user for input, issue a WRITE statement before the READ statement, for example:

```
WRITE What is your name?
READ &NAME;
```

The user sees the question “What is your name?” displayed on the terminal. The user’s typed response, for example, JOHN, becomes the value of the variable NAME. Your CLIST can then use this value in subsequent statements, such as:

```
WRITE HELLO &NAME! /* (result: HELLO JOHN!)
```

For more information about the READ and WRITE statements, see Chapter 8, “Communicating with the Terminal User” on page 83.

## Defining Symbolic Variables

### Using the PROC Statement

The PROC statement lets you pass parameters to a CLIST at invocation. The PROC statement defines symbolic variables and assigns the parameters to the variables. To do so, the PROC statement must be the first functional line of the CLIST (only comments or blank lines can precede the PROC statement).

#### Passing Parameters to a PROC Statement

When invoking a CLIST explicitly, pass parameters in single quotes, for example:

```
EX clistname 'parm1 parm2(value)'
```

When invoking the CLIST implicitly, omit the quotes:

```
%clistname parm1 parm2(value)
```

To pass parameters that contain single quotes, you must follow special rules that are discussed in *z/OS TSO/E Command Reference*.

The PROC statement accepts two types of parameters: positional parameters and keyword parameters. Parameter values in lowercase are changed to uppercase.

#### Using PROC with Positional Parameters

You can use the PROC statement to assign parameters to variables by position. First, type a number on the PROC statement telling how many positional parameters to expect (type 0 if none). Then specify the variables that you want to use. For example, in the following PROC statement, the number 1 tells the CLIST to assign the first parameter it receives to the variable NAME.

```
PROC 1 NAME
```

Thus, if you invoke the CLIST with the parameter JOE:

```
EX clistname 'JOE'
```

the variable NAME contains the value JOE.

Suppose you wanted the PROC statement to assign a second parameter to the variable ADDRESS. You could write the statement as follows:

```
PROC 2 NAME ADDRESS
```

The invoker must know the correct order in which to pass positional parameters, and must pass as many as you specify by number on the PROC statement. If the invoker doesn't pass a positional parameter as expected, the CLIST prompts for it. Positional parameters can have up to 252 characters (A-Z, 0-9, #, \$, @, \_).

#### Using PROC with Keyword Parameters

When input parameters are optional or can have default values, use the PROC statement to assign the parameters to variables by name rather than by position. Such parameters (*keyword parameters*) must match a variable name that you specify on the PROC statement. See item 5 on page 18 for special rules on naming variables specified on the PROC statement. The PROC statement can accept keyword parameters with or without values.

Keyword parameters and their matching variables have up to 31 alphanumeric characters (A-Z, 0-9, #, \$, @). Keyword parameter *values* have the same length restriction as symbolic variable values: 32768 bytes.

#### Keywords with Values

If a CLIST has a value that applies to most but not all uses of the CLIST, you can provide a default value and allow invokers to override it with a keyword parameter.



## Defining Symbolic Variables

In the following example, the 0 tells the CLIST to expect no positional parameters. (If there are no positional parameters, a zero is required.) The notation STATE(NY) gives the variable STATE the default value of NY.

```
PROC 0 STATE(NY)
```

The invoker can override the default value by passing the keyword parameter with another value, for example:

```
EX clistname 'STATE(NJ)'
```

or

```
%clistname STATE(NJ)
```

Then the variable STATE takes the value NJ.

If you want a variable to have no default value but allow invokers to specify a value, use empty parentheses. The following PROC statement lets invokers pass keyword parameters such as STATE(NY) or STATE(NJ).

```
PROC 0 STATE()
```

In the example above, if an invoker passes the keyword parameter STATE without a value, the CLIST prompts for the value. If an invoker does not pass the keyword STATE at all, the variable STATE takes a null value.

### Keywords without Values

You can use keyword parameters without values to let invokers specify a CLIST option. For example, to let an invoker tell a CLIST to print its results, you could code the following:

```
PROC 0 PRINT
```

Then, if the invoker passes the keyword parameter PRINT:

```
EX clistname 'PRINT'
```

the variable PRINT takes the value PRINT. If the invoker does not pass the parameter PRINT, the variable PRINT takes a null value. Your CLIST can test the value to see if the invoker wants the print option. You can code this test using an IF-THEN-ELSE sequence:

```
PROC 0 PRINT
IF &PRINT = PRINT THEN (print results) /* If the value of PRINT = print ...*/
ELSE ...
```

(For more information about the IF-THEN-ELSE sequence, see “The IF-THEN-ELSE Sequence” on page 66.)

### Using PROC with both Positional and Keyword Parameters

The following PROC statement receives both positional and keyword parameters:

```
PROC 2 NAME ADDRESS STATE(NY) ZIP() PRINT
```

The number 2 indicates that the invoker must pass positional parameters for the first two variables, NAME and ADDRESS. Invokers can also pass keyword parameters with values for the variables STATE (the default value is NY) and ZIP (which has no default). In addition, invokers can pass the keyword parameter PRINT without a value, to specify a print option.

## Defining Symbolic Variables

### Examples

The following CLIST addresses a memo based on PROC variables, displaying the address at the terminal. You could also use I/O statements (described in Chapter 9, "Performing File I/O" on page 95) to write the address to a data set.

```
/******
/* Memo-addressing CLIST
/******
PROC 2 NAME ADDRESS STATE(NY) ZIP()
WRITE TO: &NAME
WRITE AT: &ADDRESS
WRITE &STATE &ZIP
```

Assume that the CLIST resides in the member MEMO of a partitioned data set called PROC.CLIST. If you invoked it as follows:

```
ex proc(memo) 'Perry_Gordon 22_Oak_St._Pokville ZIP(10101)'
```

You would see the following output at your terminal:

```
TO: PERRY_GORDON
AT: 22_OAK_ST._POKVILLE
NY 10101
```

If you invoked it without parameters, for example,

```
ex proc(memo)
```

the CLIST would prompt you for a name and address. The state would default to NY, and there would be no zip code.

The following CLIST issues the LISTDS command using the PROC, READ, and SET statements to define variables and assign values to them.

```
/******
/* This CLIST issues the LISTDS command, using a data set name and */
/* any options requested by the user. If the user enters OPTIONS */
/* as a parameter, READ and WRITE statements prompt for the options. */
/* The CLIST gets a LISTDS return code from the &LASTCC control */
/* variable, and writes the return code to the screen. */
/******
PROC 1 DATASET OPTIONS /* Get a data set name */
IF &OPTIONS = OPTIONS THEN /* If the user wants options, */ +
 DO /* prompt for input */
 WRITE Type LISTDS options (MEMBER, HISTORY, or STATUS)
 READ OPT
 END
LISTDS &DATASET &OPT /* List data set with any options */
SET RETURN_CODE = &LASTCC /* Get return code from LISTDS */
WRITE RETURN_CODE WAS &RETURN_CODE
```

---

## More Advanced Uses of Variables

The previous sections of this chapter discussed several basic ways to define and assign values to symbolic variables, using the SET, READ, and PROC statements. Other chapters describe how to use symbolic variables in more advanced applications with other CLIST statements:

- The GLOBAL, NGLOBAL, SYSCALL, and SYSREF statements let you define variables for use in nested CLISTs and CLIST subprocedures. See Chapter 7, "Structuring CLISTs" on page 65 for information about using variables with these statements.

## More Advanced Uses of Variables

- The I/O statements OPENFILE, CLOSEFILE, GETFILE, and PUTFILE use symbolic variables to send and receive input between files. See Chapter 9, “Performing File I/O” on page 95 for information about using variables with these statements.
- The LISTDSI statement uses a special set of CLIST variables for retrieving information about data set attributes. See Chapter 5, “Using Control Variables” on page 27 for information about this statement and its variables.

## Combining Symbolic Variables

You can combine one symbolic variable with another symbolic variable to form a compound variable.

Suppose a CLIST invokes programs that reside in nine data sets named PROGRAM1 through PROGRAM9. By combining &PROGRAM and &I; you can use the iterative DO loop structure to invoke PROGRAM1 through PROGRAM9 as follows:

```
SET PROGRAM = PROGRAM
DO &I = 1 to 9
 call mylib(&PROGRAM&I)
END
```

(For more information about using an iterative DO loop, see “The Iterative DO Sequence” on page 71.) By increasing the value of I from one to nine in a loop, a CLIST could invoke the following set of programs without having to modify the CALL command.

```
PROGRAM1
PROGRAM2
 ⋮
PROGRAM9
```

You can also combine symbolic variables and character strings. When the variable precedes the character string, place a period after the symbolic variable to distinguish it from the character string:

```
&PROGRAM.A
```

No period is required when the character string precedes the symbolic variable because the ampersand distinguishes the variable from the string:

```
A&PROGRAM
```

## Using a Variable to Preserve Leading Spaces in a CLIST

When TSO/E processes a job in a CLIST, statements following the *DD \** statement are left adjusted to column 1, thereby removing leading spaces. (This is unique to CLIST processing and is not a batch concern.) If you need to preserve the blanks, set a variable to a single blank or a string of blanks to provide as many blanks as required, that is *&STR( )* and precede all statements following the *DD \** with that variable. The following example shows how to include the variable within your CLIST.

```
PROC01
CONTROL
SET &A = STR()
SUBMIT * END(XX)
//JOB CARD
//OTHER
//JCL
//CARDS
// DD *
```

## More Advanced Uses of Variables

```
&A COPY ...
&A ...
&A ...
&A ...
```

## Nesting Symbolic Variables

In some situations, you might want to store the name of a variable in another variable. For example, if you had to process two variables in the same way, you could assign their names to a third variable.

When you store the name of a variable in another variable, you are “nesting” variables.

To nest one variable in another variable, use an assignment statement with double ampersands. For example, to nest the variable &CAT in the variable &MAMMAL, code:

```
SET MAMMAL = &&CAT /* result: &MAMMAL contains &CAT */
```

The double ampersands (&&) prevent the CLIST from performing symbolic substitution on the variable string &CAT. In the assignment statement, the CLIST removes only the first ampersand, setting &MAMMAL to the value &CAT.

It is most useful to nest variables when you have to process many variables that have similar names. For example, if you have to set &VARIABLE to different variables such as &LINE1, &LINE2, during processing, you could code many SET statements, or code the following sequence:

```
SET NUMBER=0
SET VARIABLE=&&LINE&NUMBER /* Initialize &VARIABLE to &LINE0 */
DO WHILE &NUMBER<8 /* Process from &LINE1-&LINE8 */
 SET NUMBER = &NUMBER+1 /* Increase &NUMBER to create next
 /* variable name */
 SET VARIABLE=&&LINE&NUMBER /* Set &VARIABLE to next variable
 /* name */
 (processing)
END
```

For more examples of using nested variables, see “&SYSOUTLINE” on page 46, and “Allocating Data Sets to SYSPROC - The SPROC CLIST” on page 133.

If you nest variables whose values contain double ampersands, the outermost variable contains the name of the innermost variable. For example, after the following statements execute, VARIABLE contains &LINE1 and DATA contains the value 430.

```
SET LINE1=430
SET NUMBER=1
SET VARIABLE=&&LINE&NUMBER
SET DATA=&VARIABLE
```

## Combining Nested Variables with Character Strings

As previously stated, you can combine a preceding variable with a character string by placing a period between them (&PROGRAM.A). If the preceding variable is nested, place an additional period after the variable for each level of nesting. For example,

```
SET &BUDGET = June
SET &PROGRAM = &budget
call mylib(&PROGRAM.A) /* result: call mylib(JuneA)
```

If the character string precedes the variable, no period is required:

```
SET &BUDGET = June
SET &PROGRAM = &budget
call mylib(A&PROGRAM) /* result: call mylib(AJune)
```

### Substitution of Nested Variables

If a CLIST encounters nested symbolic variables in a line, it normally scans the line (performs symbolic substitution) multiple times until all symbolic variables are resolved. For example:

```
SET A = 50
SET B = &&C /* result: &B contains &C
SET C = &A+50 /* result: &C contains 100
SET D = &&A /* result: &D contains &A
SET X = (&D+&B)/&D /* result: &X contains 3
```

To resolve the fifth expression the CLIST uses the values assigned to the symbolic variables A-D and assigns the value 3 to X.

You can limit the number of times the CLIST scans a line of nested variables, using the &SYSNSUB built-in function. For example, you could specify that the CLIST scan the fifth expression in the preceding example only once, so the variables were resolved to only one level of symbolic substitution. As a result, the CLIST would resolve &X from (&D+&B)/&D to (&A+&C)/&A, and go no further. See Chapter 6, “Using Built-in Functions” on page 51 for a description and examples of &SYSNSUB.

### Combining Variables Containing DBCS Data

When variables containing data of the double-byte character set (DBCS) are combined with other DBCS data, contiguous DBCS delimiters are removed to create a single DBCS string. For example:

```
SET A = <d1d2>
SET B = <d3d4>&A<d5d6> /* result: &B = <d3d4d1d2d5d6>
```

## More Advanced Uses of Variables

---

## Chapter 5. Using Control Variables

|                                                          |    |
|----------------------------------------------------------|----|
| Overview of using Control Variables . . . . .            | 28 |
| Getting the Current Date and Time . . . . .              | 32 |
| &SYSDATE, &SYSSDATE, and &SYSJDATE . . . . .             | 32 |
| &SYS4DATE, &SYS4SDATE, and &SYS4JDATE . . . . .          | 33 |
| &SYSTIME and &SYSSTIME . . . . .                         | 33 |
| Getting Terminal Characteristics . . . . .               | 33 |
| &SYSTEMID . . . . .                                      | 34 |
| &SYSLTERM and &SYSWTERM . . . . .                        | 34 |
| Getting Information about the User . . . . .             | 34 |
| &SYSUID . . . . .                                        | 34 |
| &SYSPREF . . . . .                                       | 34 |
| &SYSPROC . . . . .                                       | 35 |
| Getting Information about the System . . . . .           | 35 |
| &SYSCLONE . . . . .                                      | 35 |
| &SYSCPU and &SYSSRV . . . . .                            | 36 |
| &SYSDFP . . . . .                                        | 36 |
| &SYSHSM . . . . .                                        | 36 |
| &SYSISPF . . . . .                                       | 37 |
| &SYSJES . . . . .                                        | 37 |
| &SYSLRACF . . . . .                                      | 37 |
| &SYSAPPCLU . . . . .                                     | 37 |
| &SYSMVS . . . . .                                        | 38 |
| &SYSNAME . . . . .                                       | 38 |
| &SYSNODE . . . . .                                       | 38 |
| &SYSOPSYS . . . . .                                      | 39 |
| &SYSRACF . . . . .                                       | 39 |
| &SYSPLEX . . . . .                                       | 39 |
| &SYSSECLAB . . . . .                                     | 40 |
| &SYSSMS . . . . .                                        | 40 |
| &SYSSMFID . . . . .                                      | 40 |
| &SYSSYMDEF . . . . .                                     | 40 |
| &SYSTSOE . . . . .                                       | 41 |
| Getting Information about the CLIST . . . . .            | 41 |
| &SYSENV . . . . .                                        | 41 |
| &SYSSCAN . . . . .                                       | 42 |
| &SYSICMD . . . . .                                       | 42 |
| &SYSPCMD . . . . .                                       | 42 |
| &SYSSCMD . . . . .                                       | 42 |
| Relationship between &SYSPCMD and &SYSSCMD . . . . .     | 42 |
| &SYSNEST . . . . .                                       | 42 |
| Setting Options of the CLIST CONTROL Statement . . . . . | 42 |
| &SYSPROMPT . . . . .                                     | 43 |
| &SYSSYMLIST . . . . .                                    | 43 |
| &SYSCONLIST . . . . .                                    | 43 |
| &SYSLIST . . . . .                                       | 43 |
| &SYSASIS . . . . .                                       | 44 |
| &SYSMSG . . . . .                                        | 44 |
| &SYSFLUSH . . . . .                                      | 44 |
| Getting Information about User Input . . . . .           | 45 |
| &SYSDLM . . . . .                                        | 45 |
| &SYSDVAL . . . . .                                       | 45 |
| Trapping TSO/E Command Output . . . . .                  | 46 |
| &SYSOUTTRAP . . . . .                                    | 46 |

|                                                                |    |
|----------------------------------------------------------------|----|
| &SYSOUTLINE . . . . .                                          | 46 |
| Considerations for Using &SYSOUTTRAP and &SYSOUTLINE . . . . . | 47 |
| Getting Return Codes and Reason Codes . . . . .                | 47 |
| &LASTCC . . . . .                                              | 47 |
| &MAXCC . . . . .                                               | 48 |
| Getting Results of the TSOEXEC Command . . . . .               | 49 |
| Getting Data Set Attributes . . . . .                          | 49 |
| The LISTDSI Statement . . . . .                                | 49 |

The CLIST language includes a set of control variables. Control variables provide information about MVS, TSO/E, and the current session, such as levels of software available, the time of day, and the date. Your CLISTs can use the control variables to obtain such current information.

You code a control variable as you would a symbolic variable. For example, to get the time of day, your CLIST could use the control variable &SYSTIME as follows:

```
WRITE It's &SYSTIME
```

If your CLIST was executing at 2:32:58 PM, the result would be:

```
It's 14:32:58
```

You do not have to define control variables. Control variables have constant names; you simply refer to the variable name to obtain information.

Control variables to which you can assign values are called *modifiable* control variables. The variable &SYSOUTTRAP is an example of a modifiable control variable. &SYSOUTTRAP tells how many lines of TSO/E command output should be saved in a CLIST. If you want to save 100 lines of output from each TSO/E command in your CLIST, you can set &SYSOUTTRAP to 100, as follows:

```
SET &SYSOUTTRAP = 100
```

Your CLIST would then be able to retrieve and process up to 100 lines of output from each command in the CLIST. If you did not want to save output from some commands, you would reset &SYSOUTTRAP to zero before issuing those commands.

---

## Overview of using Control Variables

Table 3 on page 29 lists the control variables in related categories, and indicates what page they are on, whether they are modifiable, and whether they are retrievable by the variable access routine, IKJCT441. For more information about IKJCT441, refer to *z/OS TSO/E Programming Services*.

Table 4 on page 30 briefly describes the modifiable control variables, and Table 5 on page 30 briefly describes the control variables you cannot modify.

---

1. Lets you test or modify the CLIST CONTROL statement values.



## Overview of using Control Variables

Table 3. Control Variable by Category

| Category                   | Variable    | Modifiable | Retrievable by IKJCT441 | Page |
|----------------------------|-------------|------------|-------------------------|------|
| Current date and time      | &SYSDATE    | No         | No                      | 32   |
|                            | &SYSJDATE   | No         | No                      | 32   |
|                            | &SYSSDATE   | No         | No                      | 32   |
|                            | &SYS4DATE   | No         | No                      | 33   |
|                            | &SYS4JDATE  | No         | No                      | 33   |
|                            | &SYS4SDATE  | No         | No                      | 33   |
|                            | &SYSTEMTIME | No         | No                      | 33   |
|                            | &SYSSTIME   | No         | No                      | 33   |
| Terminal-related           | &SYSLTERM   | No         | No                      | 34   |
|                            | &SYSWTERM   | No         | No                      | 34   |
| User-related               | &SYSUID     | No         | No                      | 34   |
|                            | &SYSPREF    | No         | No                      | 34   |
|                            | &SYSPROC    | No         | No                      | 35   |
| System-related             | &SYSAPPCLU  | No         | No                      | 37   |
|                            | &SYSCLONE   | No         | No                      | 35   |
|                            | &SYSCPU     | No         | No                      | 36   |
|                            | &SYSDFP     | No         | No                      | 36   |
|                            | &SYSHSM     | No         | No                      | 36   |
|                            | &SYSISPF    | No         | No                      | 37   |
|                            | &SYSJES     | No         | No                      | 37   |
|                            | &SYSLRACF   | No         | No                      | 37   |
|                            | &SYSMVS     | No         | No                      | 38   |
|                            | &SYSNAME    | No         | No                      | 38   |
|                            | &SYSNODE    | No         | No                      | 38   |
|                            | &SYSOPSYS   | No         | No                      | 39   |
|                            | &SYSRACF    | No         | No                      | 39   |
|                            | &SYSPLEX    | No         | No                      | 39   |
|                            | &SYSSECLAB  | No         | No                      | 40   |
|                            | &SYSSMFID   | No         | No                      | 40   |
|                            | &SYSSMS     | No         | No                      | 40   |
|                            | &SYSSRV     | No         | No                      | 36   |
|                            | &SYSSYMDEF  | No         | No                      | 40   |
|                            | &SYSTEMID   | No         | No                      | 34   |
| &SYSTSOE                   | No          | No         | 41                      |      |
| CLIST-related              | &SYSSCAN    | Yes        | Yes                     | 42   |
|                            | &SYSENV     | No         | No                      | 41   |
|                            | &SYSICMD    | No         | No                      | 42   |
|                            | &SYSPCMD    | No         | No                      | 42   |
|                            | &SYSSCMD    | No         | No                      | 42   |
|                            | &SYSNEST    | No         | No                      | 42   |
| CLIST-related <sup>1</sup> | &SYSPROMPT  | Yes        | Yes                     | 43   |
|                            | &SYSSYMLIST | Yes        | Yes                     | 43   |
|                            | &SYSCONLIST | Yes        | Yes                     | 43   |
|                            | &SYSLIST    | Yes        | Yes                     | 43   |
|                            | &SYSASIS    | Yes        | Yes                     | 44   |
|                            | &SYSMSG     | Yes        | Yes                     | 44   |
|                            | &SYSFLUSH   | Yes        | Yes                     | 44   |
| Input-related              | &SYSDLM     | No         | Yes                     | 45   |
|                            | &SYSDVAL    | Yes        | Yes                     | 45   |
| Output-related             | &SYSOUTTRAP | Yes        | Yes                     | 46   |
|                            | &SYSOUTLINE | Yes        | Yes                     | 46   |

## Overview of using Control Variables

Table 3. Control Variable by Category (continued)

| Category     | Variable  | Modifiable | Retrievable by IKJCT441 | Page |
|--------------|-----------|------------|-------------------------|------|
| Return codes | &LASTCC   | Yes        | Yes                     | 47   |
|              | &MAXCC    | Yes        | Yes                     | 48   |
|              | &SYSABNCD | Yes        | Yes                     | 49   |
|              | &SYSABNRC | Yes        | Yes                     | 49   |
|              | &SYSCMDRC | Yes        | Yes                     | 49   |

Table 4. Modifiable Control Variables (alphabetically)

| Modifiable Variable | Contents                                                                                                                                                                                                                                                                                  |
|---------------------|-------------------------------------------------------------------------------------------------------------------------------------------------------------------------------------------------------------------------------------------------------------------------------------------|
| &LASTCC             | Contains the return code from the last operation (TSO/E command, subcommand, or CLIST statement).                                                                                                                                                                                         |
| &MAXCC              | Contains the highest return code issued up to this point in the CLIST or the highest passed back from a nested CLIST.                                                                                                                                                                     |
| &SYSABNCD           | Contains the ABEND code returned by the command most recently invoked by the TSOEXEC command.                                                                                                                                                                                             |
| &SYSABNRC           | Contains the ABEND reason code returned by the command most recently invoked by the TSOEXEC command.                                                                                                                                                                                      |
| &SYSASIS            | ON specifies CONTROL NOCAPS/ASIS. OFF specifies CONTROL CAPS.                                                                                                                                                                                                                             |
| &SYSCMDRC           | Contains the command return code returned by the command most recently invoked by the TSOEXEC command.                                                                                                                                                                                    |
| &SYSCONLIST         | ON specifies CONTROL CONLIST. OFF specifies CONTROL NOCONLIST.                                                                                                                                                                                                                            |
| &SYSDVAL            | (1) Contains the input line supplied by the user when the user returned control to the CLIST after a TERMIN or TERMING statement. (2) Contains the input line supplied by the user after a READ statement without operands. (3) Contains the value after the execution of a SET SYSDVAL=. |
| &SYSFLUSH           | ON specifies CONTROL FLUSH. OFF specifies CONTROL NOFLUSH.                                                                                                                                                                                                                                |
| &SYSLIST            | ON specifies CONTROL LIST. OFF specifies CONTROL NOLIST.                                                                                                                                                                                                                                  |
| &SYSMSG             | ON specifies CONTROL MSG. OFF specifies CONTROL NOMSG.                                                                                                                                                                                                                                    |
| &SYSOUTLINE         | Contains the number of lines of command output produced by a TSO/E command; points to the CLIST variables containing the output.                                                                                                                                                          |
| &SYSOUTTRAP         | Contains the maximum number of lines of TSO/E command output to be saved.                                                                                                                                                                                                                 |
| &SYSPROMPT          | ON specifies CONTROL PROMPT. OFF specifies CONTROL NOPROMPT.                                                                                                                                                                                                                              |
| &SYSSCAN            | Contains the maximum number of times a CLIST can rescan a line to evaluate variables. The default is 16 times. The maximum value is +2,147,483,647. The minimum is 0.                                                                                                                     |
| &SYSSYMLIST         | ON specifies CONTROL SYMLIST. OFF specifies CONTROL NOSYMLIST.                                                                                                                                                                                                                            |

Table 5. Non-modifiable Control Variables (alphabetically)

| Non-modifiable Variable | Contents                                      |
|-------------------------|-----------------------------------------------|
| &SYSAPPCLU              | Contains the APPC/MVS logical unit (LU) name. |

## Overview of using Control Variables

Table 5. Non-modifiable Control Variables (alphabetically) (continued)

| Non-modifiable Variable | Contents                                                                                                                                |
|-------------------------|-----------------------------------------------------------------------------------------------------------------------------------------|
| &SYS4DATE               | Contains the current date in the form: <i>month/day/year</i> , where <i>year</i> is presented as four-digit number.                     |
| &SYS4JDATE              | Contains the Julian date in the form: <i>year.days</i> , where <i>year</i> is presented as four-digit number.                           |
| &SYS4SDATE              | Contains the date in the form: <i>year/month/day</i> , where <i>year</i> is presented as four-digit number.                             |
| &SYSCLONE               | Contains the MVS system symbol representing its system name.                                                                            |
| &SYSCPU                 | Contains the number seconds of CPU time used during the session in the form: <i>seconds.hundredths_of_seconds</i>                       |
| &SYSDATE                | Contains the current date in the form: <i>month/day/year</i>                                                                            |
| &SYSDFP                 | Contains the level of MVS/Data Facility Product (MVS/DFP) installed.                                                                    |
| &SYSDLM                 | Contains the input line supplied by the user to return control to the CLIST after a TERMIN or TERMING statement.                        |
| &SYSENV                 | Indicates whether the CLIST is executing in the foreground or background environment.                                                   |
| &SYSHSM                 | Indicates the level of the Data Facility Storage Management Subsystem Hierarchical Storage Manager (DFSMSHsm).                          |
| &SYSICMD                | Contains the name by which the invoker implicitly invoked this CLIST. (This value is null if the invoker explicitly invoked the CLIST.) |
| &SYSISPF                | Indicates whether ISPF dialog management services are available to the CLIST.                                                           |
| &SYSJDATE               | Contains the Julian date in the form: <i>year.days</i>                                                                                  |
| &SYSJES                 | Contains the name and the level of the JES installed.                                                                                   |
| &SYSLRACF               | Indicates the level of RACF available to the CLIST. (See &SYSRACF below)                                                                |
| &SYSLTERM               | Contains the number of lines available for applications on your terminal screen.                                                        |
| &SYSMVS                 | Contains the level of the base control program (BCP) component of z/OS.                                                                 |
| &SYSNAME                | Contains the system's name your CLIST is running on, as specified on the SYSNAME statement in SYS1.PARMLIB member IEASYSxx.             |
| &SYSNEST                | Indicates whether the currently executing CLIST was invoked by another CLIST.                                                           |
| &SYSNODE                | Contains the network node name of your installation's JES.                                                                              |
| &SYSOPSYS               | Contains the z/OS name, version, release, modification level, and FMID.                                                                 |
| &SYSPCMD                | Contains the name (or abbreviation of the name) of the most recently executed TSO/E command in this CLIST.                              |
| &SYSPLEX                | Contains the MVS sysplex name as found in the COUPLExx or LOADxx member of SYS1.PARMLIB.                                                |
| &SYSPREF                | Contains the prefix that TSO/E uses to fully qualify data set names.                                                                    |
| &SYSPROC                | Contains the name of the logon procedure used when the TSO/E user logged on.                                                            |
| &SYSRACF                | Indicates whether RACF is installed and available to the CLIST.                                                                         |
| &SYSSCMD                | Contains the name of the most recently executed subcommand.                                                                             |

## Overview of using Control Variables

Table 5. Non-modifiable Control Variables (alphabetically) (continued)

| Non-modifiable Variable | Contents                                                                                       |
|-------------------------|------------------------------------------------------------------------------------------------|
| &SYSSDATE               | Contains the date in the form: <i>year/month/day</i>                                           |
| &SYSSECLAB              | Contains the security label (SECLABEL) name of the TSO/E session.                              |
| &SYSSMFID               | Identifies the system on which System Management Facilities (SMF) is active.                   |
| &SYSSMS                 | Indicates whether DFSMS/MVS is available to your CLIST.                                        |
| &SYSSRV                 | Contains the number of System Resource Manager (SRM) service units used during the session.    |
| &SYSSYMDEF              | Contains the symbolic name of the MVS system.                                                  |
| &SYSTEMID               | Contains the terminal ID of the terminal where the CLIST has been started.                     |
| &SYSSTIME               | Contains the time of day in the form: <i>hours:minutes</i>                                     |
| &SYSTIME                | Contains the time of day in the form: <i>hours:minutes:seconds</i>                             |
| &SYSTSOE                | Indicates the level of TSO/E installed in the form: <i>version release modification_number</i> |
| &SYSUID                 | Contains the user ID under which the current session is logged.                                |
| &SYSWTERM               | Contains the width of the screen.                                                              |

---

## Getting the Current Date and Time

The following control variables provide information related to the current date and time. You cannot modify any of them with an assignment statement.

### &SYSDATE, &SYSSDATE, and &SYSJDATE

Three variables provide the current date. Note that these variables return the current year as a two-digit number. In support of dates equal or greater than 2000, another set of variables is provided that returns the current year as four-digit number.

&SYSDATE provides the date in the American standard form: *month/day/year*. If executed on June 9, 2001, the following statement displays the message "Today is 06/09/01":

```
WRITE Today is &SYSDATE
```

&SYSSDATE provides the date in a form that can be sorted: *year/month/day*. If executed on June 9, 2001, the following statement displays the message "Today is 01/06/09":

```
WRITE Today is &SYSSDATE
```

&SYSJDATE provides the date in the Julian form: *year.days*. If executed on June 9, 2001, the following statement displays the message "Today is 01.160":

```
WRITE Today is &SYSJDATE
```

&SYSDATE and &SYSSDATE provide data that contain slashes. As a result, when they appear in expressions on comparative and assignment statements, enclose them in &STR built-in functions. For example, in the following example &SYSDATE

## Getting Current Date and Time

appears in a statement containing comparative expressions; therefore, enclose it in a `&STR` built-in function. However, the use of `&STR` is unnecessary on the `WRITE` statement.

```
IF &STR(&SYS4DATE) = &STR(06/09/01) THEN +
WRITE On &SYS4DATE, the system was down for &TMIN minutes.
```

## `&SYS4DATE`, `&SYS4SDATE`, and `&SYS4JDATE`

Three variables provide the current date in a format that presents years as four-digit numbers. As opposed to the variables that present the current year as two-digit numbers, these variables are capable to handle years beyond 1999.

`&SYS4DATE` provides the date in the American standard form: *month/day/year*. If executed on November 22, 2001, the following statement displays the message "Today is 11/22/2001":

```
WRITE Today is &SYS4DATE
```

`&SYS4SDATE` provides the date in a form that can be sorted: *year/month/day*. If executed on November 22, 2001, the following statement displays the message "Today is 2001/11/22":

```
WRITE Today is &SYS4SDATE
```

`&SYS4JDATE` provides the date in the Julian form: *year.days*. If executed on November 22, 2001, the following statement displays the message "Today is 2001.326":

```
WRITE Today is &SYS4JDATE
```

`&SYS4DATE` and `&SYS4SDATE` provide data that contain slashes. As a result, when they appear in expressions on comparative and assignment statements, enclose them in `&STR` built-in functions. For example, in the following example `&SYS4DATE` appears in a statement containing comparative expressions; therefore, enclose it in a `&STR` built-in function. However, the use of `&STR` is unnecessary on the `WRITE` statement.

```
IF &STR(&SYS4DATE) = &STR(11/22/2001) THEN +
WRITE On &SYS4DATE, the system was down for &TMIN minutes.
```

## `&SYSTIME` and `&SYSSTIME`

Two variables provide the current time of day.

`&SYSTIME` provides the time in the form: *hours:minutes:seconds*. If executed at 2:32 and 58 seconds P.M., the following statement displays the message "It's 14:32:58":

```
WRITE It's &SYSTIME
```

`&SYSSTIME` provides a shortened version of `&SYSTIME`, in the form: *hours:minutes*. If executed at 2:32 and 58 seconds P.M., the following statement displays the message "It's 14:32":

```
WRITE It's &SYSSTIME
```

---

## Getting Terminal Characteristics

Three control variables provide information about the terminal to which the user is logged on.

## Getting Terminal Characteristics

### &SYSTEMID

&SYSTEMID contains the terminal ID of the terminal where the CLIST has been started. For example,

```
PROC 0
WRITE &SYSTEMID
EXIT
```

may return a terminal ID of M02XA06R, with a maximum length of eight characters. Trailing blanks are removed.

If your CLIST runs in the background, the &SYSTEMID control variable returns a null string.

### &SYSLTERM and &SYSWTERM

&SYSLTERM provides the number of lines available for applications on your terminal screen. &SYSWTERM provides the width of the screen.

&SYSLTERM and &SYSWTERM can be used when a CLIST reformats the screen using Session Manager commands. For example, a CLIST called HORZNTL splits the terminal screen horizontally based on the number of lines on the screen and its width. The following section of HORZNTL substitutes the control variables in the Session Manager commands that define the windows for the reformatted screen. By using &SYSLTERM and &SYSWTERM instead of explicit screen positions, HORZNTL makes optimal use of the space available on a given screen.

```
SET LINE = (&SYSLTERM-5)/2
SET TOPS = &LINE-1;
SET BOT = &LINE+1;
SET BOTS = (&SYSLTERM-1)-&BOT
SET BOTSX = (&SYSLTERM-3)-&BOT
smput /save screen;save.pfk;+
 save.win main;save.win line;save.win current;+
 del.win main;del.win line;del.win current;+
 define.window main 1 1 &TOPS &SYSWTERM;+
 define.window line &LINE 1 1 &SYSWTERM;+
 define.window current &BOT 1 &BOTS &EVAL(&SYSWTERM-18)/
```

---

## Getting Information about the User

Three control variables provide user-related information including the current user ID, logon procedure, and data set prefix.

### &SYSUID

&SYSUID provides the user ID under which the current TSO/E session is logged on. Use this variable in messages and wherever logic depends on, or references, the user ID. For example, the following message displays information about how the CLIST is invoked:

```
WRITE CLIST invoked by user &SYSUID at &SYSTIME on &SYSSDATE
```

### &SYSPREF

&SYSPREF provides the current data set name prefix that is prefixed to non-fully-qualified data set names. The PROFILE command controls this prefix. Use &SYSPREF when you want to allocate data sets that are unique to the user who invoked the CLIST. For example, the following ALLOCATE command allocates unique data sets for invokers of a CLIST containing the command:

```
alloc da('&SYSPREF..records.data') shr reuse
```

## Getting Information about the User

Two periods are required between &SYSPREF and RECORDS; the first indicates the end of the variable name, and the second is part of the text to be concatenated. After substitution, the command has the following form:

```
alloc da('prefix.records.data') shr reuse
```

## &SYSPROC

&SYSPROC provides the name of the logon procedure used when the user logged on to the current TSO/E session. You can use &SYSPROC to determine whether programs, such as Session Manager, are available to the user. For example, before invoking the CLIST (HORZNTL) that reformats the screen using Session Manager commands, verify that Session Manager is active. One way to make the verification is to check the logon procedure as follows:

```
IF &STR(&SYSPROC) = SMPROC THEN +
%horzntl
ELSE +
DO
WRITE Your screen cannot be reformatted.
WRITE Log on using SMPROC as logon proc.
END
```

&SYSPROC provides the following values:

- When the CLIST is invoked in the foreground (&SYSENV provides 'FORE'), &SYSPROC will provide the name of the current LOGON procedure.
- When the CLIST is invoked in batch (from a job submitted via the SUBMIT command), &SYSPROC will provide the value 'INIT', which is the ID for the initiator.
- When the CLIST is invoked from a Started Task (an address space that is started via the Start operator command), &SYSPROC will provide the ID of the started task. If 'S procname' is issued from the operator console, &SYSPROC will provide the value 'procname'.

---

## Getting Information about the System

The following control variables provide information about the system environment under which the CLIST is executing.

You can use these control variables in your CLISTs for different purposes. For example, the variables &SYSNAME, &SYSPLEX, &SYSCLONE, and &SYSSYMDEF allow you to write common CLISTs that are to run in a sysplex environment. You can build or identify the system-specific data set names by using the values returned by these control variables.

## &SYSCLONE

&SYSCLONE returns the MVS system symbol representing its system name. It is a 1- to 2-byte shorthand notation for the system name. The value is obtained from SYS1.PARMLIB member IEASYMxx<sup>2</sup>. For example, if SYSCLONE(A1) is specified in IEASYMxx, then

```
PROC 0
WRITE &SYSCLONE
EXIT
```

---

2. Introduced with MVS/ESA SP 5.2; provides a mechanism to assign system substitution symbols names and values.

## Getting Information about the System

returns a value of A1. A null string is returned if no MVS SYSCZONE ID is specified in IEASYMxx.

## &SYSCPU and &SYSSRV

&SYSCPU provides the number of seconds of central processing unit (CPU) time used during the session in the form: *seconds.hundredths\_of\_seconds*.

&SYSSRV provides the number of System Resource Manager (SRM) service units used during the session.

These variables can be used for measuring the performance of applications and reporting session duration to the user.

For example, to measure the performance of an application invoked from a CLIST, you can code the following:

```
SET CPU = &SYSCPU
SET SRV = &SYSSRV
call mylib(payroll) '50,84'
SET CPU = &STR(&SYSCPU-&CPU)
SET SRV = &STR(&SYSSRV-&SRV)
call mylib(calc) '&STR(&CPU),&STR(&SRV)' /* Measure performance */
:
: /* Do calculations and pass back results */
:
WRITE &CPU &SRV
```

The user can then see the number of seconds of CPU time and SRM service units used by the program PAYROLL.

## &SYSDFP

&SYSDFP contains the level of MVS/Data Facility Product (MVS/DFP) installed. For example,

```
PROC 0
WRITE &SYSDFP
EXIT
```

may return a value of 02.02.10.00. The value returned is in the format *cc.vv.rr.mm*, where *cc* is the component, *vv* the version, *rr* the release number, and *mm* the modification level. All values are two-digit decimal numbers.

A value of 00 for *cc* indicates a pre-DFSMS/MVS component, whereas any value other than 00 indicates a DFSMS/MVS component or a follow-on component.

## &SYSHSM

&SYSHSM indicates the level of the Data Facility Storage Management Subsystem Hierarchical Storage Manager (DFSMSHsm).

When DFSMSHsm for OS/390 V2R10 or higher is active with PTF UW77424 applied, &SYSHSM contains a character string of four two-digit decimal numbers separated by periods. This represents the four-byte level in the MQCT\_VRM field of the ARCQCT. For example, if DFSMSHsm for OS/390 V2R10 is active with PTF UW77424 applied, &SYSHSM contains: 02.02.10.00

**Note:** For a description of the MQCT\_VRM field in the ARCQCT control block, see OS/390 V2R10 or z/OS *DFSMS Migration*.



## Getting Information about the System

When DFSMSHsm prior to OS/390 V2R10 is installed and active, &SYSHSM contains a character string of four decimal digits. This represents the level of DFSMSHsm. For example, if DFSMSHsm 1.5.0 is installed and active, &SYSHSM contains: 1050

When the Hierarchical Storage Manager is not active &SYSHSM contains a null string.

### &SYSISPF

&SYSISPF indicates whether ISPF dialog manager services are available. The variable can have one of two values:

|                   |                              |
|-------------------|------------------------------|
| <b>ACTIVE</b>     | ISPF services are available. |
| <b>NOT ACTIVE</b> | ISPF is not initialized.     |

### &SYSJES

&SYSJES contains the name and the level of the JES installed. For example,

```
PROC 0
WRITE &SYSJES
EXIT
```

may return JES2 0S 2.10. In this example JES2 is the JES name and 0S 2.10 is the JES level, representing version and release number of JES2. The JES level may contain a modification level as well.

The values returned are provided by the subsystem interface request routine (IEFSSREQ).

Both strings are separated by a blank character; any trailing blank characters are removed. If either the JES name or level returns an empty character string, then no separating blank character is inserted.

If the subsystem is not active the string -INACTIVE- is returned (note the string delimiters).

If the system finds that the subsystem is neither JES2 4.3 or later nor JES3 5.1.1 or later, the &SYSJES control variable contains the string -DOWNLEVEL- (note the string delimiters).

### &SYSLRACF

&SYSLRACF indicates the level of RACF installed on the system. If RACF is not installed, &SYSLRACF contains a null value.

### &SYSAPPCLU

&SYSAPPCLU contains the MVS/APPC logical unit (LU) name. The LU name identifies the TSO/E address space your CLIST will be running in as the SNA addressable unit for Advanced-Program-to-Program-communication (APPC). The LU name is obtained via the APPC/MVS Advanced TP Callable Services (ATBEXAI - Information Extract Service). For example,

```
PROC 0
WRITE &SYSAPPCLU
EXIT
```

## Getting Information about the System

may return an LU name of LU0001. Trailing blanks are removed. A null string is returned if:

- There is no APPC activity in the address space the CLIST is running in, or
- No LU name is provided by the APPC/MVS Advanced TP Callable Services.

**Note:** CLISTs do *not* support CPI Communication (a method to let one program communicate with another program on the same or other MVS system in an SNA network). Therefore the use of the &SYSAPPCLU control variable makes sense only in a CLIST that is invoked by a program (for example, a REXX exec) that has established APPC. If the control variable is used outside this environment, a null string is returned.

## &SYSMVS

&SYSMVS contains the level of the base control program (BCP) component of z/OS. For example,

```
PROC 0
WRITE &SYSMVS
EXIT
```

may return SP7.0.1 as the level of the BCP component.

The value returned is that of the CVTPRODN field in the communications vector table (CVT).

**Note:** The format of the value returned by &SYSMVS may change in future, but will remain the content of the CVTPRODN field.

**OS/390 Users:** To provide customers with the least disruptive change when changing from MVS/ESA SP 5.x to OS/390, the format of the CVTPRODN field is maintained and contains SP5.3.0 for OS/390 Release 1. This is because some products test byte 3 to see if it is "5", which indicates that certain functions are available.

## &SYSNAME

&SYSNAME returns the system's name your CLIST is running on, as specified in SYS1.PARMLIB member IEASYSxx on the SYSNAME statement. For example,

```
PROC 0
WRITE &SYSNAME
EXIT
```

may return ATQS as the MVS system name.

You may want to use the &SYSNAME control variable to identify on which system in a multi-system global resource serialization complex your CLIST is running on. See *z/OS MVS Initialization and Tuning Reference*, on how the SYSNAME value is used in a multi-system complex.

## &SYSNODE

&SYSNODE contains the network node name of your installation's JES. This name identifies the local JES in a network of systems or system complexes being used for network job entry (NJE) tasks. For example,

```
PROC 0
WRITE &SYSNODE
EXIT
```

## Getting Information about the System

may return a value of B0E9, which is the network node name of your local JES.

The node name returned by the &SYSNODE control variable derives from the NODE initialization statement of JES.

If the system finds that the subsystem is not active, the &SYSNODE control variable contains the string -INACTIVE- (note the string delimiters).

If the system finds that the subsystem is neither JES2 4.3 or later nor JES3 5.1.1 or later, the &SYSNODE control variable contains the string -DOWNLEVEL- (note the string delimiters).

## &SYSOPSYS

&SYSOPSYS contains the z/OS name, version, release, modification level, and FMID of your installation's z/OS. For example,

```
PROC 0
WRITE &SYSOPSYS
EXIT
```

may return a string of Z/OS 01.01.00 JBB7713, where Z/OS represents the product name, followed by a blank character, followed by an eight-character string representing version, release, modification number, followed by a blank character, followed by the FMID.

The &SYSOPSYS control variable was introduced after TSO/E Version 2 Release 5 with APAR OW17844. If you use this variable in a environment earlier than TSO/E 2.5, or without the PTF associated with APAR OW17844, the system returns a null string.

**Note:** To display the operating system product name as "z/OS" instead of "Z/OS", a CONTROL ASIS or CONTROL NOCAPS statement must be included prior to the &SYSOPSYS statement. Also notice that a "/" character will appear in the product name, for example, in "z/OS". CLISTS might interpret that character to be the divide operator. For example, SET LEVEL=&SYSOPSYS might produce an error message. To prevent a CLIST from evaluating the resulting string you should use the &STR function; for example, SET LEVEL=&STR(&SYSOPSYS).

## &SYSRACF

&SYSRACF indicates the status of RACF. The variable can have one of three values:

|                      |                              |
|----------------------|------------------------------|
| <b>AVAILABLE</b>     | RACF services are available. |
| <b>NOT AVAILABLE</b> | RACF is not initialized.     |
| <b>NOT INSTALLED</b> | RACF is not installed.       |

## &SYSPLEX

&SYSPLEX returns the MVS sysplex name as found in the COUPLExx or LOADxx member of SYS1.PARMLIB. For example,

```
PROC 0
WRITE &SYSPLEX
EXIT
```

## Getting Information about the System

may return a value of PLEXNY02. The value has a maximum of eight characters; trailing blanks are removed. If no sysplex name is specified in SYS1.PARMLIB, &SYSPLEX returns a null string.

## &SYSSECLAB

&SYSSECLAB returns the SECLABEL name that is valid for the TSO/E session where the CLIST is started. For example,

```
PROC 0
WRITE &SYSSECLAB
EXIT
```

may return a value of SYSHIGH as the current security label name. Trailing blanks are removed.

**Note:** The use of the &SYSSECLAB control variable requires that RACF is installed, and that security label checking has been activated. If no security information is found, the &SYSSECLAB control variable contains a null string.

## &SYSSMS

&SYSSMS indicates whether DFSMS/MVS is available to your CLIST. For example,

```
PROC 0
WRITE &SYSSMS
EXIT
```

returns one of the following character strings:

|                    |                                                                    |
|--------------------|--------------------------------------------------------------------|
| <b>UNAVAILABLE</b> | DFSMS/MVS is not available on your system.                         |
| <b>INACTIVE</b>    | DFSMS/MVS is available on your system but not active.              |
| <b>ACTIVE</b>      | DFSMS/MVS is available and active, so your CLIST can depend on it. |

**Note:** This control variable requires MVS/Data Facility Product (MVS/DFP) Version 3.3 or later. If used with lower releases, an error message is issued.

## &SYSSMFID

&SYSSMFID identifies the system on which System Management Facilities (SMF) is active. The value returned is as specified in SYS1.PARMLIB member SMFPRMxx on the SID statement. Trailing blanks are removed. For example,

```
PROC 0
WRITE &SYSSMFID
EXIT
```

returns ATQS as the SMF ID. Note that the value returned by &SYSSMFID and &SYSNAME may be the same in your installation. See *z/OS MVS Initialization and Tuning Reference*, for more details on the SYSNAME and SID statement in member SMFPRMxx.

## &SYSSYMDEF

&SYSSYMDEF(*symbol\_name*) returns the value represented by the variable "*symbol\_name*" as specified in SYS1.PARMLIB member IEASYMxx on the

## Getting Information about the System

SYSDEF ... SYMDEF statement. Or, the 'string' can also be one of the system static or dynamic symbols as defined in *z/OS MVS Initialization and Tuning Reference*.

For example, if SYMDEF(&SYSTEMA = 'SA') is specified in IEASYMxx, then

```
PROC 0
WRITE &SYSSYMDEF(SYSTEMA)
EXIT
```

returns a value of SA. A null string is returned if the symbolic name is not specified in IEASYMxx, and it is not one of the MVS defined static or dynamic symbols.

Here, the symbol name SYSTEMA is assigned a name of SA on the SYMDEF statement in IEASYMxx. The &SYSSYMDEF(*symbol\_name*) control variable resolves to a string of SA.

You can also retrieve the value for one of the MVS defined static or dynamic system symbols. For example:

```
WRITE &SYSSYMDEF(JOBNAME) /*Returns JOBNAME
 BOB perhaps */
```

Refer to *z/OS MVS Initialization and Tuning Reference* for a discussion and a list of the currently defined MVS static and dynamic system symbols.

For example, you can retrieve the IPL Volume Serial Name of your system using

```
WRITE &SYSSYMDEF(SYSR1) /* may return 640S06
 as IPL Vol. Ser. Name */
```

The SYSSYMDEF function goes through CLIST substitution first, the result of which must be a 1-8 character name specifying the symbol that has been defined in the SYMDEF statement. Any other values including CLIST delimiters may cause unpredictable results.

## &SYSTSOE

&SYSTSOE indicates the level of TSO/E installed on the system. For OS/390 Version 2 Release 4 and later, &SYSTSOE returns 2060.

---

## Getting Information about the CLIST

The following control variables provide information about the CLIST.

## &SYSENV

&SYSENV indicates whether the CLIST is executing in the foreground (FORE) or the background (BACK). You can use this variable when a CLIST must make logical decisions based on the environment. For example, the way a CLIST obtains its input is sensitive to background and foreground executions. You can use &SYSENV to prevent the CLIST executing READ statements in the background as follows:

```
GLOBAL LNAME /* Define global variable to be set by FETCHNAM */
:
:
IF &SYSENV=FORE THEN +
DO
WRITE Enter your last name.
READ LNAME
END
ELSE +
%fetchnam
```

## Getting Information about the CLIST

### &SYSSCAN

&SYSSCAN contains a number that defines the maximum number of times symbolic substitution is performed on each line in a CLIST. The default number is 16. You can assign &SYSSCAN a value from 0 to +2,147,483,647 ( $2^{31}-1$ ). A zero limit inhibits all scans, preventing any substitution of values for symbolic variables.

For example, to write a record containing an ampersand (&), and prevent a CLIST from performing erroneous symbolic substitution, you can code the following:

```
 :
 SET &SYSSCAN=0 /* Prevent symbolic substitution
 WRITE Jack & Jill went up the hill
 SET &SYSSCAN=16 /*Reset &SYSSCAN
```

### &SYSICMD

&SYSICMD contains the name by which the user *implicitly* invoked the currently executing CLIST. If the user invoked the CLIST explicitly, this variable has a null value.

### &SYSPCMD

&SYSPCMD contains the name of the TSO/E command that the CLIST most recently executed. The *initial* value of &SYSPCMD depends on the environment from which the CLIST was invoked. If the invoker used the EXEC command, the *initial* value is EXEC. If the invoker used the EXEC subcommand of EDIT, the *initial* value is EDIT.

### &SYSSCMD

&SYSSCMD contains the name of the TSO/E subcommand that the CLIST most recently executed. If invoker used the EXEC command, the *initial* value of &SYSSCMD is null. If the invoker used the EXEC subcommand of EDIT, the *initial* value is EXEC.

## Relationship between &SYSPCMD and &SYSSCMD

The &SYSPCMD and &SYSSCMD control variables are interdependent. Following the initial invocation, the values of &SYSPCMD and &SYSSCMD depend on the TSO/E command or subcommand most recently executed. For example, if the value of &SYSSCMD is EQUATE, a subcommand unique to the TEST command, the value of &SYSPCMD is TEST.

You can use &SYSPCMD and &SYSSCMD in error and attention exits to determine where the error or attention interrupt occurred.

### &SYSNEST

&SYSNEST indicates whether the currently executing CLIST is nested. (A nested CLIST is one that was invoked by another CLIST rather than explicitly by the user.) If the CLIST is nested, &SYSNEST contains the value YES. If it is not nested, &SYSNEST contains the value NO.

---

## Setting Options of the CLIST CONTROL Statement

The following control variables let you test or modify options of the CLIST CONTROL statement. For full information about the CONTROL statement and its options, see "CONTROL Statement" on page 154.

### &SYSPROMPT

&SYSPROMPT indicates whether the CONTROL statement's PROMPT or NOPROMPT option is active. The value 0N indicates that CONTROL PROMPT is active, and TSO/E commands in the CLIST can prompt the terminal for input. 0FF indicates that CONTROL NOPROMPT is active, and TSO/E commands cannot prompt the terminal.

Your CLISTs can use &SYSPROMPT to test which option is active, or change the option. For example, if you want the CLIST to allow prompting from the LISTDS command only, you can code:

```
SET &SYSPROMPT = 0N
LISTDS
SET &SYSPROMPT = 0FF
```

### &SYSSYMLIST

&SYSSYMLIST indicates whether the CONTROL statement's SYMLIST or NOSYMLIST option is active. The value 0N indicates that CONTROL SYMLIST is active, and CLIST statements are displayed at the terminal before being scanned for symbolic substitution. The value 0FF indicates that CONTROL NOSYMLIST is active, and CLIST statements are not displayed at the terminal before symbolic substitution.

Your CLISTs can use &SYSSYMLIST to test which option is in effect, or to change the option. For example, if you suspect an error in part of a CLIST and you want to display certain statements before substitution, you could code:

```
SET &SYSSYMLIST = 0N
:
(suspected statements in error)
:
SET &SYSSYMLIST = 0FF
```

### &SYSCONLIST

&SYSCONLIST indicates whether the CONTROL statement's CONLIST or NOCONLIST option is active. The value 0N indicates that CONTROL CONLIST is active, and CLIST statements are displayed at the terminal *after* symbolic substitution. The value 0FF indicates that CONTROL NOCONLIST is active, and CLIST statements are not displayed at the terminal after symbolic substitution.

Your CLISTs can use &SYSCONLIST to test which option is in effect, or to change the option. For example, if you suspect an error in part of a CLIST and you want to display certain statements after substitution, you could code:

```
SET &SYSCONLIST = 0N
:
(suspected statements in error)
:
SET &SYSCONLIST = 0FF
```

### &SYSLIST

&SYSLIST indicates whether the CONTROL statement's LIST or NOLIST option is active. The value 0N indicates that CONTROL LIST is active, and TSO/E commands and subcommands are displayed at the terminal *after* symbolic substitution. The value 0FF indicates that CONTROL NOLIST is active, and commands and subcommands are not displayed at the terminal after symbolic substitution.

## Setting Options of the CLIST CONTROL Statement

Your CLISTs can use &SYSLIST to test which option is in effect, or to change the option. For example, if you suspect an error in part of a CLIST and you want to display certain commands or subcommands, you could code:

```
SET &SYSLIST = ON
 :
 (suspected commands in error)
 :
SET &SYSLIST = OFF
```

## &SYSASIS

&SYSASIS indicates whether the CONTROL statement's ASIS option is active. The value ON indicates that CONTROL ASIS is active, and lowercase characters are not converted to uppercase before processing. The value OFF indicates that CONTROL CAPS is active, and lowercase characters are converted to uppercase.

Your CLISTs can use &SYSASIS to test which option is in effect, or to change the option. For example, if you want READ and WRITE statements to preserve lowercase letters, you could code:

```
SET &SYSASIS = ON
WRITE Enter data exactly as you want it to appear.
WRITE Lowercase letters won't be changed to uppercase.
READ &U1c_data
```

## &SYSMSG

&SYSMSG indicates whether the CONTROL statement's MSG or NOMSG option is active. The value ON indicates that CONTROL MSG is active, and the CLIST can display informational messages at the terminal. The value OFF indicates that CONTROL NOMSG is active, and the CLIST cannot display informational messages at the terminal.

Your CLISTs can use &SYSMSG to test which option is in effect, or to change the option. For example, if you wanted to make sure that informational messages are displayed at the terminal, you could code:

```
SET &SYSMSG = ON
 :
```

## &SYSFLUSH

&SYSFLUSH indicates whether the CONTROL statement's FLUSH or NOFLUSH option is active. The value ON indicates that CONTROL FLUSH is active, and the system can erase (flush) any nested CLISTs when an error occurs. The value OFF indicates that CONTROL NOFLUSH is active, and the system cannot flush nested CLISTs. When CONTROL MAIN is active, &SYSFLUSH cannot be set to ON.

Your CLISTs can use &SYSFLUSH to test which option is in effect, or to change the option. For example, if your CLIST invokes other CLISTs, you can set &SYSFLUSH to OFF to protect them from being flushed in the event of an error. You could then use an error routine to recover from the error and continue processing.

```
SET &SYSFLUSH = OFF
ERROR +
 DO
 :
 (error routine)
 :
END
```



## Setting Options of the CLIST CONTROL Statement

For more information about error routines and protecting nested CLISTs, see Chapter 10, “Writing ATTN and ERROR Routines” on page 101.

---

### Getting Information about User Input

Two control variables are related to input supplied to a CLIST.

#### &SYSDLM

&SYSDLM (“DLM” is for *delimiter*) contains a number that identifies the position (first, second, third, and so on) of the TERMIN or TERMING statement character string entered by the user to return control to the CLIST.

You can use this variable to determine what action should be taken when the user returns control to the CLIST, based on the string chosen. For example, the following statements inform the user what is requested (WRITE), pass control to the terminal and establish valid control character strings (TERMIN or TERMING), and determine the subsequent action based on the string entered.

```
WRITE The first phase of BUDGET has completed with
WRITE a return code of &RCODE
WRITE Enter YES if you want the results printed.
WRITE Enter NO if you do not want them printed.
TERMIN YES NO
IF &SYSDLM = 1 THEN +
 :
 (Print results)
 :
```

#### &SYSDVAL

&SYSDVAL (“DVAL” is for *default value*) contains one of the following at any given time:

- A null value
- The input the user entered when returning control to the CLIST after a TERMIN or TERMING statement
- The user’s response after a READ statement without operands
- The value assigned to &SYSDVAL by an assignment statement.

Initially, &SYSDVAL contains a null value. It can also contain a null value, if:

- The user does not enter anything but a pre-defined character string or null line after a TERMIN or TERMING statement.
- The user does not enter any input after a READ statement without operands.
- You assign a null value to &SYSDVAL.

You can also use &SYSDVAL when performing I/O to a data set. You can assign the data to variables by defining SYSDVAL as the file name of the data set and naming the variables on the READVAL statement. For an example of using &SYSDVAL and READVAL in I/O, see “Using &SYSDVAL When Performing I/O - The PHONE CLIST” on page 132.

---

### Trapping TSO/E Command Output

Two control variables allow you to trap TSO/E command output in a CLIST: &SYSOUTTRAP and &SYSOUTLINE. These variables save output from TSO/E commands and allow a CLIST or application to process the output. You can modify the values of &SYSOUTTRAP and &SYSOUTLINE with assignment statements. For example, the assignment statement

```
SET &SYSOUTTRAP = 100
```

lets you trap and save 100 lines of output from a TSO/E command.

#### &SYSOUTTRAP

Use &SYSOUTTRAP to specify the maximum number of lines of TSO/E command output to be saved. If you want to save all the output from a TSO/E command, set &SYSOUTTRAP to a number greater than or equal to the number of output lines that the command produces. Any output lines produced in excess of the &SYSOUTTRAP value are not saved.

To save the output of a single command, set &SYSOUTTRAP to zero after issuing the command. Otherwise, output from subsequent commands may replace the original saved output.

#### &SYSOUTLINE

When you use &SYSOUTTRAP, the CLIST saves TSO/E command output in variables beginning with &SYSOUTLINE.

The CLIST uses the variable &SYSOUTLINE to record the number of output lines produced by a command. The CLIST saves the actual command output in the variables &SYSOUTLINE $nn$ , where  $nn$  represents the positional number of the line being saved.  $nn$  can be any decimal number up to 21 digits in length. However, the value in &SYSOUTTRAP and the amount of storage available determine the actual number of lines saved.

The following CLIST traps output from the TSO/E LISTD command, retrieves it using nested variables, and writes each line of output.

```
PROC 0 DATASET(DEFAULT)
IF &DATASET = DEFAULT THEN +
 DO
 WRITE What data set do you want to process?
 READ DATASET
 END
SET &SYSOUTTRAP = 1000 /* Expect command produces no */
/* more than 1000 lines */
LISTD '&SYSPREF..&DATASET' MEMBERS /* List data set members */
SET B = &SYSOUTLINE /* Get number of lines produced */
SET &SYSOUTTRAP = 0 /* Reset &SYSOUTTRAP */
SET A = 1 /* Initialize counter */
DO WHILE /* Loop for the lesser of */
 (&A <= 1000) AND /* num of lines expected and */
 (&A <= &B) /* num of lines produced */
 SET MEMBER = &STR(&&SYSOUTLINE&A) /* Get a &SYSOUTLINE nn variable */
 WRITE &STR(&MEMBER) /* Write the output line */
 SET A = &A +1 /* Increase the line counter */
END /* End of loop on counter */
```

For another example of using &SYSOUTTRAP and &SYSOUTLINE to process command output, see “Allocating Data Sets to SYSPROC - The SPROC CLIST” on page 133.

## Considerations for Using &SYSOUTTRAP and &SYSOUTLINE

- If you add the CONTROL LIST and SYMLIST options to a CLIST that uses &SYSOUTTRAP, more output lines are produced and you might need to adjust &SYSOUTTRAP and &SYSOUTLINE $nn$  values to retrieve the desired output lines.
- To trap the output of TSO/E commands under ISPF/PDF, you must invoke a CLIST with command output trapping *after* ISPF or one of its services has been invoked.
- The output of authorized commands listed under the AUTHCMDS parameter in the active IKJTSOxx parmlib member cannot be trapped by a CLIST invoked under any application that builds its own ECT. For example, a CLIST must be prefixed by the TSO subcommand of IPCS to trap the output of authorized commands when invoked from IPCS under ISPF.
- If you try to display a line of output in &SYSOUTLINE $nn$  where  $nn$  is greater than the value of &SYSOUTTRAP, the &SYSOUTLINE $nn$  variable contains unreliable data.
- If you try to display a &SYSOUTLINE $nn$  variable that contains no command output, the CLIST returns a null line.
- Because CLISTs use the TSO/E EXEC command to invoke nested CLISTs, &SYSOUTTRAP saves all output of nested CLISTs as TSO/E command output. Therefore, if you need to trap all of the output of a command processor that processes several subcommands, consider using a nested CLIST to do so.
- &SYSOUTTRAP does not save command output sent to the terminal by a TPUT macro, but does save output from the PUTLINE macro with DATA or INFOR keywords.
- Whenever a CLIST starts to execute a TSO/E command or subcommand, it resets &SYSOUTLINE to zero. However, if a CLIST invokes a CLIST or a non-CLIST program containing TSO/E commands, the invoked program does not reset &SYSOUTLINE to zero for each TSO/E command. To record the number of command output lines in an invoked program, use an assignment statement to reset &SYSOUTLINE to zero before each TSO/E command. For information about assigning a value to CLIST variables in a non-CLIST environment, see *z/OS TSO/E Programming Services*.

---

## Getting Return Codes and Reason Codes

Two control variables enable you to obtain return codes and reason codes. You can modify both &LASTCC and &MAXCC with an assignment statement.

### &LASTCC

When you use &LASTCC outside an error routine, &LASTCC contains the return code from the last TSO/E command or subcommand, nested CLIST, or CLIST statement executed. Because the value of this variable is updated after the execution of each statement or command, store its value in a symbolic variable before executing code that references the value.

In an error routine, &LASTCC is not updated after the execution of each statement or command. Only the RETURN statement updates the value of &LASTCC. If you use &LASTCC in an error routine, &LASTCC contains the return code from the command or statement that was executing when the error occurred.

## Getting Return Codes and Reason Codes

&LASTCC does not support negative return codes. When a negative return code is received from a REXX exec, CLIST converts it to binary, removes the first byte, and stores the remainder in &LASTCC as a positive decimal integer.

When &LASTCC receives an error return code from a TSO/E command, subcommand, nested CLIST, or CLIST statement, control passes to an error routine if present in the CLIST. However, when &LASTCC contains the return code from a subprocedure RETURN statement, control does *not* pass to an error routine.

&LASTCC can be used in error routines that handle multiple error conditions. For example, if an error routine handles arithmetic errors, it can use &LASTCC to determine what type of message to display at the terminal:

```
ERROR +
DO
 SET RCODE = &LASTCC
/* Character data in operands? */
 IF &RCODE = 852 THEN +
 WRITE Character data was found in numbers being added.
/* Numeric value too large? */
 IF &RCODE = 872 THEN +
 WRITE A numeric value in the addition was too large.
 (Other tests)
 ⋮
RETURN
END
SET SUM = &VALUE1 + &VALUE2 + &VALUE3;
```

Note that &LASTCC itself does not get updated within the error routine.

When an error occurs during CLIST I/O processing, use an error routine to obtain the error code in &LASTCC. For example, to trap the error code generated by OPENFILE when attempting to open a file (BADFILE) that does not exist, code the following CLIST:

```
PROC 0
ERROR DO
SET RC=&LASTCC.
RETURN
END
OPENFILE BADFILE
WRITE LASTCC=&RC
```

See Table 8 on page 111 for a list of the CLIST error codes that &LASTCC can contain.

## &MAXCC

&MAXCC contains the highest return code returned by a nested CLIST or by a TSO/E command, subcommand, or CLIST statement in the currently executing CLIST.

&MAXCC is not set when a subprocedure returns to the CLIST.

You can use &MAXCC with &LASTCC to determine error conditions. For example, error codes caused by evaluation errors are in the 800-899 range. You can modify the error routine in the example under &LASTCC to determine first whether the error was caused by an arithmetic evaluation. Insert the following IF-THEN-ELSE sequence before the check for character data in operands:

```
⋮
/* Evaluation error? */
```

```
IF &MAXCC <800 OR &MAXCC >899 THEN +
 GOTO ...
ELSE +
 :
```

---

## Getting Results of the TSOEXEC Command

Three variables are related to the use of the TSOEXEC command: &SYSABNCD, &SYSABNRC, and &SYSCMDRC. You can modify any one of them with an assignment statement.

&SYSABNCD, &SYSABNRC, and &SYSCMDRC contain, respectively, the ABEND code, ABEND reason code, and command return code returned by the command most recently invoked by the TSOEXEC command. You can use these variables in situations similar to those in which you would use &LASTCC and &MAXCC. For example, to determine if the TRANSMIT command terminated abnormally, you can code:

```
tsoexec transmit plpsc.d00abc1 dataset(letter.text)
/* Abend code non-zero? */
IF &SYSABNCD≠0 THEN +
DO
 WRITE The transmission of LETTER.TEXT to
 WRITE PLPSC.D00ABC1 abended.
END
```

---

## Getting Data Set Attributes

Control variables include certain predefined variables set by CLIST statements. The LISTDSI statement sets a number of variables with information about data set attributes. These LISTDSI variables cannot be modified.

### The LISTDSI Statement

You can use the LISTDSI (*list data set information*) statement to retrieve detailed information about a data set's attributes. The statement stores the information in CLIST variables. The CLIST can use the information to determine if the data set has enough space or the correct format for a given task. The CLIST can also use the information as input to the TSO/E ALLOCATE command to create a new data set with some attributes of the old data set while modifying others.

To retrieve a data set's allocation information, specify the data set's name on the LISTDSI statement. You can also specify that a data set migrated by the Data Facility Hierarchical Storage Manager (DFHSM) be recalled, and that directory information be retrieved for a partitioned data set.

In response to the LISTDSI statement, the CLIST stores each of the data set's allocation attributes in a specific variable. For example, the data set's primary space allocation is stored in the variable &SYSPRIMARY, and its organization is stored in &SYSDSORG. For a complete list of the CLIST variables set by LISTDSI, see "LISTDSI Statement" on page 162.

For an example of using LISTDSI, see "Allocating a Data Set with LISTDSI Information - The EXPAND CLIST" on page 146.

## Getting Data Set Attributes

## Chapter 6. Using Built-in Functions

|                                                                          |    |
|--------------------------------------------------------------------------|----|
| Determining the Data Type of an Expression - &DATATYPE . . . . .         | 52 |
| Forcing Arithmetic Evaluations - &EVAL . . . . .                         | 53 |
| Determining an Expression's Length in Bytes - &LENGTH . . . . .          | 53 |
| Suppressing Arithmetic Evaluations . . . . .                             | 53 |
| Including Leading and Trailing Blanks and Leading Zeros . . . . .        | 54 |
| Determining an Expression's Length in Characters - &SYSCLENGTH. . . . .  | 54 |
| Preserving Double Ampersands - &NRSTR . . . . .                          | 54 |
| Double Ampersands . . . . .                                              | 54 |
| One Level of Symbolic Substitution . . . . .                             | 54 |
| Records Containing JCL Statements . . . . .                              | 55 |
| Temporary Data Set Names . . . . .                                       | 55 |
| Symbolic Parameters . . . . .                                            | 55 |
| Defining Character Data - &STR . . . . .                                 | 55 |
| Using &STR with &SYSDATE or &SYSSDATE . . . . .                          | 56 |
| Using &STR with Leading and Trailing Blanks . . . . .                    | 56 |
| Using &STR with Strings that Match CLIST Statement Names . . . . .       | 56 |
| Using &STR When Supplying Input Using SYSIN JCL Statements . . . . .     | 56 |
| Defining a Substring - &SUBSTR . . . . .                                 | 57 |
| Defining a Substring - &SYSCSUBSTR . . . . .                             | 59 |
| Converting Character Strings to Uppercase Characters - &SYSCAPS. . . . . | 59 |
| Converting Character Strings to Lowercase Characters - &SYSLC . . . . .  | 59 |
| Determining Data Set Availability - &SYSDSN . . . . .                    | 59 |
| Locating One Character String Within Another - &SYSINDEX . . . . .       | 60 |
| Using &SYSINDEX with DBCS Strings . . . . .                              | 61 |
| Limiting the Level of Symbolic Substitution - &SYSNSUB . . . . .         | 62 |
| Converting DBCS Data to EBCDIC - &SYSONEBYTE . . . . .                   | 63 |
| Converting EBCDIC Data to DBCS - &SYSTWOBYTE . . . . .                   | 63 |

The CLIST language includes built-in functions that you can perform on variables, expressions, and character strings. If necessary, CLIST evaluates the variable or expression first, and then performs the requested function. The CLIST then stores the result under the name of the built-in function.

To use a built-in function, type its name, followed by the variable, expression, or character string in parentheses. The variable, expression, or character string is also called the *argument* of the built-in function. The argument must immediately follow the built-in function name, with no blanks between them. Table 6 describes each of the built-in functions briefly and gives page numbers where you can find more information.

Table 6. Built-in Functions

| Built-in Function         | Function                                                                                        | Page |
|---------------------------|-------------------------------------------------------------------------------------------------|------|
| &DATATYPE(expression)     | Indicates whether the evaluation of <i>expression</i> is a character string or a numeric value. | 52   |
| &EVAL(expression)         | Performs an arithmetic evaluation of <i>expression</i> .                                        | 53   |
| &LENGTH(expression)       | Evaluates <i>expression</i> if necessary and indicates the number of bytes in the result.       | 53   |
| &NRSTR(string)            | Preserves double ampersands, defines non-rescannable strings.                                   | 54   |
| &STR(string)              | Defines data to be used as a character string.                                                  | 55   |
| &SUBSTR(exp[:exp],string) | Uses certain bytes in a character string.                                                       | 57   |
| &SYSCAPS(string)          | Converts the string to uppercase characters.                                                    | 59   |
| &SYSCLENGTH(expression)   | Evaluates <i>expression</i> if necessary and indicates the number of characters in the result.  | 54   |

## Using Built-in Functions

Table 6. Built-in Functions (continued)

| Built-in Function                    | Function                                                                                                       | Page |
|--------------------------------------|----------------------------------------------------------------------------------------------------------------|------|
| &SYSCSUBSTR(exp[:exp],string)        | Uses certain characters in a character string.                                                                 | 59   |
| &SYSDSN(dsname[(member)])            | Indicates whether the specified data set exists.                                                               | 59   |
| &SYSINDEX(string_1,string_2[,start]) | Finds the position of a character string (string_1) within another (string_2), from a specific starting point. | 60   |
| &SYSLOC(string)                      | Converts the string to lowercase characters.                                                                   | 59   |
| &SYSNSUB(level,expression)           | Limits the level of symbolic substitution in the expression.                                                   | 62   |
| &SYSONEBYTE(string)                  | Converts a string of data from the double-byte character set (DBCS) to EBCDIC.                                 | 63   |
| &SYSTWOBYTE(string)                  | Converts a string of data from EBCDIC to the double-byte character set (DBCS).                                 | 63   |

In addition to these built-in functions, TSO/E provides an installation exit that lets your installation add its own CLIST built-in functions. For information about the exit, see *z/OS TSO/E Customization*.

**Note:** With the exception of &SYSNSUB, built-in functions will not resolve double ampersands (&&) that appear in an argument.

---

## Determining the Data Type of an Expression - &DATATYPE

Use the &DATATYPE built-in function to determine what type of data an evaluated expression contains. After evaluating the expression, a CLIST replaces this built-in function with one of the following strings: CHAR, NUM, DBCS, or MIXED. The strings indicate the following:

- CHAR -- The evaluated expression contains at least one non-numeric EBCDIC character and no double-byte character set (DBCS) characters.
- NUM -- The evaluated expression is entirely numeric.
- DBCS -- The evaluated expression is a single delimited string of DBCS data.
- MIXED -- The evaluated expression contains both DBCS and EBCDIC data.

The following examples show the evaluations of various expressions:

```
SET A = &DATATYPE(ALPHABET) /* result: &A = CHAR
SET B = &DATATYPE(1234) /* result: &B = NUM
SET C = &DATATYPE(SYS1;PROCLIB) /* result: &C = CHAR
SET D = &DATATYPE(3*2/4) /* result: &D = NUM
SET E = &DATATYPE(12.34) /* result: &E = CHAR
```

For example, the following clause evaluates as true:

```
IF &DATATYPE(12.34)=CHAR THEN
```

The following examples use the convention *d1d2* to represent two DBCS characters and < and > to represent the shift-out and shift-in delimiters (X'0E' and X'0F') that mark the beginning and end of the DBCS string.

```
SET A = &DATATYPE(<d1d2>) /* result: &A = DBCS
SET B = &DATATYPE(ABC<d1d2>123) /* result: &B = MIXED
SET C = &DATATYPE(<>) /* result: &C = DBCS
SET D = &DATATYPE(A<>C) /* result: &D = MIXED
SET E = &DATATYPE(<d1d2><d3d4>) /* result: &E = MIXED
```

For example, the following clauses evaluate as true:

```
IF &DATATYPE(<d1d2d3>)=DBCS THEN
IF &DATATYPE(A<d1d2d3>B)=MIXED THEN
```



## Forcing Arithmetic Evaluations - &EVAL

On most statements, the appearance of arithmetic expressions results in evaluations of those expressions when a CLIST executes the statements. However, on the WRITE statement, you must explicitly instruct a CLIST to evaluate an arithmetic expression by using the &EVAL built-in function. For example, to create a WRITE statement that adds two variables, &FNUM and &SNUM, and displays the results, code the following:

```
WRITE &FNUM + &SNUM = &EVAL(&FNUM+&SNUM)
```

Assuming &FNUM is four and &SNUM is three, the CLIST displays the following message:

```
4 + 3 = 7
```

## Determining an Expression's Length in Bytes - &LENGTH

Use the &LENGTH built-in function to determine the number of bytes in an expression or character string. &LENGTH performs symbolic substitution and arithmetic evaluations before determining the length. If a variable has a null value, &LENGTH returns a value of zero.

For example, after the following statement executes, &LENANSWR has the value 2 because there are two bytes in the result of the addition, 11.

```
SET LENANSWR = &LENGTH(1+1+9)
```

&LENGTH can also reference symbolic variables. Assume you want to save a value that is triple the length of the value of a variable called &CSTRING. To save the value in a variable called &NXTFIELD, code:

```
SET NXTFIELD = 3 * &LENGTH(&CSTRING)
```

If &CSTRING contains the value 100, &NXTFIELD contains the value 9.

If a string contains data of the double-byte character set (DBCS), &LENGTH counts each DBCS character as two bytes, and counts each DBCS delimiter as one byte. For example, using *d1d2* to denote two DBCS characters and using < and > to represent the DBCS delimiters X'0E' and X'0F':

```
SET A = &LENGTH(<d1d2>) /* result: &A = 6
```

The same is true when a string contains mixed EBCDIC and DBCS characters. For example:

```
SET A = &LENGTH(ABC<d1d2>) /* result: &A = 9
```

## Suppressing Arithmetic Evaluations

If you do not want a CLIST to perform arithmetic evaluations of a &LENGTH expression, enclose the expression in a &STR built-in function as follows:

```
SET LENANSWR = &LENGTH(&STR(1+1+9))
```

After the previous statement executes, &LENANSWR contains the value 5.

## Expression's Length - &LENGTH

### Including Leading and Trailing Blanks and Leading Zeros

If you want leading and trailing blanks and leading zeros in a &LENGTH expression included in the assignment, enclose the expression in a &STR built-in function. Otherwise, the blanks and zeroes are ignored.

For example, suppose that you want to save the length of the variable &IFIELD in a variable called &SLNGTH. The contents of &IFIELD are 0 472.20. Include &IFIELD in the &STR built-in function to include the blanks and the leading zero as part of the assignment:

```
SET SLNGTH= &LENGTH(&STR(&IFIELD))
```

After the previous statement executes, &SLNGTH contains the value 8.

---

## Determining an Expression's Length in Characters - &SYSCLENGTH

Use &SYSCLENGTH built-in function to determine the number of characters in an expression or string that contains characters of the double-byte character set (DBCS). &SYSCLENGTH differs from &LENGTH in that &SYSCLENGTH counts each DBCS character as one character instead of two bytes, and does not count DBCS delimiters. For example:

```
SET A = &SYSCLENGTH(<d1d2>) /* result: &A = 2
```

The same is true when a string contains mixed EBCDIC and DBCS characters. For example:

```
SET A = &SYSCLENGTH(ABC<d1d2>) /* result: &A = 5
```

Except for the difference in counting DBCS characters, &SYSCLENGTH is identical to &LENGTH.

---

## Preserving Double Ampersands - &NRSTR

You can use the &NRSTR built-in function to prevent a CLIST from:

- Removing the first ampersand when it encounters a character string with a prefix of double ampersands.
- Performing more than one level of symbolic substitution on a variable.

You can use &NRSTR with JCL statements that include the name of a temporary data set (for example, &&TEMP). Using &NRSTR prevents a CLIST from changing the name of a temporary data set (&&TEMP) to a symbolic parameter (&TEMP).

## Double Ampersands

To assign the character string &&DATA to the variable &FILE, code:

```
SET FILE = &NRSTR(&&DATA)
```

## One Level of Symbolic Substitution

To set two variables, &A and &C, to the value &B code:

```
 ⋮
SET A = &&B
```

```
SET C = &NRSTR(&A)
 :
```

After the execution of the first SET statement, &A contains the value &B. When the second SET statement is executed, the CLIST performs symbolic substitution and substitutes &B for &A. &NRSTR prevents any further scan of the statement; therefore, &C is assigned the value &B.

## Records Containing JCL Statements

The following paragraphs discuss the use of the &NRSTR built-in function when processing records that contain JCL statements.

### Temporary Data Set Names

If a JCL statement contains a temporary data set name (for example, &&TEMP), enclose the statement in a &NRSTR built-in function to prevent the CLIST from removing the first ampersand. The following CLIST uses &NRSTR to preserve a temporary data set name in a JCL statement.

```
submit *
//&sysuid job 'Y2803P,?,S=C','SteveR',msgclass=r,class=j
// exec pgm=IEFBR14
//dd1 dd dsn=&NRSTR(&&temp),disp=(,pass),unit=sysda
&null
```

### Symbolic Parameters

If a JCL statement contains a symbolic parameter (for example, &LIBRARY),; use the &SYSNSUB built-in function to prevent the CLIST from performing erroneous symbolic substitution. Assume that the preceding CLIST contained the JCL statement:

```
//dd2 dd dsn=&library,disp=(,pass),unit=sysda
```

To prevent any symbolic substitution, you can enclose the symbolic parameter &library in the &SYSNSUB built-in function as follows:

```
//dd2 dd dsn=&SYSNSUB(0,&library),disp=(,pass),unit=sysda
```

The number 0 in parentheses after &SYSNSUB tells the CLIST how many levels of symbolic substitution you want performed on the parameter (in this case, zero levels). For more information about the &SYSNSUB built-in function, see “Limiting the Level of Symbolic Substitution - &SYSNSUB” on page 62.

---

## Defining Character Data - &STR

Use the &STR built-in function to define character data and prevent the CLIST from evaluating it. The data can be any expression or statement, and can include nested variables and characters of the double-byte character set (DBCS) within DBCS delimiters.

For example, the statement SET DIMENSNS=&STR(2\*4) defines 2\*4 as a character string and assigns the string to the variable &DIMENSNS; Without the &STR built-in function, you could not make the desired assignment because a CLIST would evaluate 2\*4 as an arithmetic expression and set &DIMENSNS to the value 8.

The &STR built-in function suppresses arithmetic evaluations only for the data between the parentheses. If you set &STATS to &DIMENSNS,; &STATS; will contain the value 8, not the character string 2\*4. To preserve the character string, code:

```
SET STATS=&STR(&DIMENSNS)
```

## Defining Character Data - &STR

Special procedures are required when defining parentheses as character data. Unlike other CLIST operators, left and right parentheses can appear at the beginning or in the middle of character data without having to be defined as character data. Only when they appear at the end of a character string do parentheses have to be defined with &STR, like the other operators.

The following examples show how to define right and left parentheses to appear as character data at the end of a character string called TEXT:

RIGHT PARENTHESIS:

```
SET &A =)
SET &B = TEXT&STR(&A) /* result: B = TEXT)
```

LEFT PARENTHESIS:

```
SET &C = &STR(
SET &D = TEXT&STR(&C) /* result: D = TEXT(
```

## Using &STR with &SYSDATE or &SYSSDATE

If you use &SYSDATE or &SYSSDATE on a CLIST statement other than WRITE, enclose the variable in an &STR built-in function. Otherwise, a CLIST views the slashes separating the day, month, and year as division operators and performs division.

```
SET TODAY = &STR(&SYSDATE)
```

## Using &STR with Leading and Trailing Blanks

Use the &STR built-in function to preserve leading and trailing blanks in a character string. For example, the following statement sets the variable &CMNDFLD to a blank, 2 hyphens, a greater than symbol, and four blanks:

```
SET CMNDFLD= &STR(-->)
```

## Using &STR with Strings that Match CLIST Statement Names

You can use the &STR built-in function to distinguish installation-written commands that match the names of CLIST statements. For example, if your installation had written a command named NGLOBAL, you could use &STR to issue the command from a CLIST and prevent the CLIST from misinterpreting it as the NGLOBAL statement:

```
&STR(NGLOBAL)
```

Similarly, to issue the SELECT subcommand of the RACF command RACFRW, you need to use the &STR built-in function to distinguish the subcommand from the SELECT statement. For more information, see "Distinguishing the SELECT Statement from the RACF SELECT Subcommand" on page 69.

## Using &STR When Supplying Input Using SYSIN JCL Statements

When you submit a background job that invokes a program, you sometimes include a '//SYSIN DD \*' JCL statement that supplies the input statements. If any input statement contains leading blanks or is the same as a CLIST statement, enclose that statement in a &STR built-in function. For example, suppose a hypothetical language called SES has an IF-THEN-ELSE sequence. If you were to include such a sequence in the SYSIN input statements, you would have to enclose it in an &STR built-in function as shown in the following background invocation of a hypothetical SES program called MATRIX.

```

PROC 1 FORMAT ACCT() CLASS(A)
CONTROL MAIN
:
submit * end(nn)
//&SYSUID1 JOB &ACCT,&SYSUID,CLASS=&CLASS;
//STEP1 EXEC PGM=MATRIX
:
//SYSIN DD *
&STR(IF &FORMAT=1 THEN OPEN DS1)
&STR(ELSE OPEN DS2)
GETFILES 1-12
&STR(SET COLUMNS=GETFILES)
:
nn

```

Only those input statements that contain leading blanks or are the same as CLIST statements are enclosed in &STR built-in functions. If the CLIST invoked MATRIX in the foreground, the &STR built-in functions would be unnecessary because the program's statements would appear in the data set containing MATRIX. Thus, they would be associated with the program, not the CLIST.

---

## Defining a Substring - &SUBSTR

Use the &SUBSTR built-in function to request that a CLIST use only certain bytes of an indicated string when performing substitution. You indicate the starting and ending positions of the string from which the substitution is made.

For example, assuming a variable called &ANIMALS contains the character string "DOGSCATSSEALS", to set a variable called &FELINE to the character string "CATS", code the following:

```
SET FELINE = &SUBSTR(5:8,&ANIMALS)
```

Note that the character string "CATS" begins in the fifth position of &ANIMALS and ends in the eighth position.

A &SUBSTR built-in function can contain other built-in functions. Assume your CLIST receives input from the user and assigns it to a variable called &NAME. &NAME contains a person's first and middle initial followed immediately by the last name. To add a blank between the initials and the last name, you can set a variable called &NFIELD to a character string consisting of the following:

1. The first and middle initials
2. A blank
3. The last name.

```
SET NFIELD = &STR(&SUBSTR(1:2,&NAME) &SUBSTR(3:&LENGTH(&NAME)+
, &NAME))
```

If you want the substring to contain only one character, you can omit the colon and end-expression. For example, if you are interested only in the first letter of the last name, code the following:

```
SET FLTRLNAME = &SUBSTR(3,&NAME)
```

You can substitute variables for starting and ending expressions. For instance, to set the section of &STRING beginning at the second position and ending at the eighth position to a variable called &WIDGET, you can create a variable and substitute it in the SET statement. Assume that the substring data represents a part number.

## Defining a Substring - &SUBSTR

```
SET PART# = &STR(2:8,)
SET WIDGET = &SUBSTR(&PART#&STRING)
```

When a variable is named in &SUBSTR, arithmetic evaluation of the variable's contents is suppressed, as in &STR. For example:

```
SET DIMENSNS = &STR(2*4)
SET X = &SUBSTR(1:2,&DIMENSNS) /* result: X = 2*
```

However, when another built-in function such as &LENGTH is specified in the &SUBSTR, the variable within the built-in function is evaluated before the &SUBSTR. To protect that variable from arithmetic evaluation, use &STR.

```
SET DIMENSNS = &STR(2*4)
SET X = &SUBSTR(1:&LENGTH(&STR(&DIMENSNS)),&DIMENSNS)
/* result: X = 2*4
```

If a string contains data of the double-byte character set (DBCS), &SUBSTR counts each DBCS character as two bytes, and counts each DBCS delimiter as one byte. For example, using *d1d2* to denote two DBCS characters and using *<* and *>* to denote the DBCS delimiters X'0E' (shift-out) and X'0F' (shift-in):

```
SET X = &SUBSTR(8:9(A<d1d2>BC) /* result: X = BC
```

When &SUBSTR returns DBCS data, &SUBSTR encloses the data between the DBCS delimiters X'0E' and X'0F'. &SUBSTR attempts to return the exact bytes requested. However, when the starting or ending positions of the substring are DBCS data or DBCS delimiters, &SUBSTR makes the following adjustments:

| If the substring:                             | &SUBSTR does the following:                                                                    |
|-----------------------------------------------|------------------------------------------------------------------------------------------------|
| Starts on the first byte of a DBCS character  | Replaces that byte with a single-byte blank and the right-next byte with a shift-out delimiter |
| Starts on the second byte of a DBCS character | Replaces that byte with a shift-out delimiter                                                  |
| Starts on a shift-in delimiter                | Replaces that byte with a single-byte blank                                                    |
| Ends on shift-out delimiter                   | Replaces that byte with a single-byte blank                                                    |
| Ends on the first byte of a DBCS character    | Replaces that byte with a shift-in delimiter                                                   |
| Ends on the second byte of a DBCS character   | Replaces that byte with a single-byte blank and the left-next byte by a shift-in delimiter.    |

In addition, if the adjustment causes a not valid DBCS character, or a contiguous pair of DBCS delimiters, &SUBSTR replaces those by single-byte blanks. However, SUBSTR does not change any contiguous pairs of DBCS delimiters that were part of the original data string.

The following are several examples of the adjustment process. In the examples, the characters s, Dn, <, >, and b denote a single-byte character, double-byte character, shift-out delimiter, shift-in delimiter, and single-byte blank, respectively.

```
&SUBSTR(4:10,ss<D1D2D3D4>) /* result: b<D2D3>
&SUBSTR(5:11,ss<D1D2D3D4>) /* result: <D2D3>b
&SUBSTR(6:10,ss<D1><D3D4>) /* result: b<D3>
&SUBSTR(1:3,ss<D1D2D3D4>) /* result: ssb
&SUBSTR(3:5,ss<D1D2D3D4>) /* result: bbb
```

## Defining a Substring - &SUBSTR

Because &SUBSTR may truncate data in DBCS strings, you can use &SYSCSUBSTR as an alternative to &SUBSTR for DBCS data.

---

## Defining a Substring - &SYSCSUBSTR

Use the &SYSCSUBSTR built-in function when you want a CLIST to treat double-byte character set (DBCS) characters as single characters in a substring operation. &SYSCSUBSTR differs from &SUBSTR in that &SYSCSUBSTR counts each DBCS character as one character, and does not count DBCS delimiters. If resulting substrings begin or end with DBCS characters, &SUBSTR adds DBCS delimiters as needed. For example:

```
SET X = &SUBSTR(2:3,<d1d2d3>) /* result: X = <d2d3>
```

The same is true if a string contains both EBCDIC and DBCS characters:

```
SET Y = 1260
&SUBSTR(1:3,AB<d1d2d3>) /* result: X = AB<d1>
```

Except for the difference in treating DBCS characters, &SYSCSUBSTR is identical to &SUBSTR.

---

## Converting Character Strings to Uppercase Characters - &SYSCAPS

Use &SYSCAPS to convert character strings to uppercase characters. &SYSCAPS does not modify special characters or DBCS characters included in the string. If a string begins with leading zeros, &SYSCAPS strips them off. Otherwise, &SYSCAPS does not modify numbers in the string. You can use variables containing the character strings in &SYSCAPS built-in functions.

You can use &SYSCAPS with &SYS LC to control the capitalization of text in a CLIST. For an example, see “Controlling Uppercase and Lowercase for READ Statement Input” on page 90.

---

## Converting Character Strings to Lowercase Characters - &SYS LC

Use &SYS LC to convert character strings to lowercase characters. &SYS LC does not modify numbers, special characters, or DBCS characters included in the string. You can use variables containing the character strings in &SYS LC built-in functions. For data to be changed to lowercase, CONTROL ASIS or NOCAPS must be in effect or &SYS ASIS must be set to the value ON.

---

## Determining Data Set Availability - &SYS DSN

Use the &SYS DSN built-in function to determine whether a specified data set or a specified data set and member exist and are available for use. If a data set has been migrated, &SYS DSN attempts to recall it. The data set name can be the name of any cataloged data set or cataloged partitioned data set with a member name. Additionally, if you specify a member of a partitioned data set, &SYS DSN checks whether you have access to the data set.

To suppress TSO/E messages issued by the &SYS DSN function, use the CONTROL NOMSG statement. For information about the CONTROL statement, see “CONTROL Statement” on page 154.

&SYS DSN returns one of the following values:

## Determining Data Set Availability - &SYSDSN

```
OK /* the data set or the data set and member exist
 /* and are available
MEMBER SPECIFIED, BUT DATASET IS NOT PARTITIONED
MEMBER NOT FOUND
DATASET NOT FOUND
ERROR PROCESSING REQUESTED DATASET
PROTECTED DATASET /* a member was specified but the
 /* data set is RACF-protected
VOLUME NOT ON SYSTEM
UNAVAILABLE DATASET /* another user has an exclusive
 /* ENQ on the specified data set
INVALID DATASET NAME, data-set-name
MISSING DATA SET NAME
```

When a data set is available for use, you may find it useful to get more detailed information. For example, if you later need to invoke a service that requires a specific data set organization, then use the LISTDSI statement. For a description of the LISTDSI statement, see “LISTDSI Statement” on page 162.

For example, you can use the &SYSDSN built-in function with conditional logic (see Chapter 7, “Structuring CLISTS” on page 65) to determine which data set to allocate for use in a CLIST.

```
IF &SYSDSN('SYS1.MYLIB')=OK THEN +
DO
 alloc f(utility) da('SYS1.MYLIB')
 call (iecompar)
END
ELSE +
IF &SYSDSN('SYS1.INSTLIB(IECOMPAR)')=OK THEN +
DO
 alloc f(utility) da('SYS1.INSTLIB')
 call iecompar
END
ELSE +
 :
 :
```

Enclose fully-qualified data set names in single quotes when they appear in &SYSDSN built-in functions. You can use variables containing data set names in &SYSDSN built-in functions.

The &SYSDSN function issues message IKJ56709I if a syntactically not valid data set name is passed to the function. To prevent this message from being displayed, use CONTROL NOMSG.

```
PROC 0
SET DSNNAME = ABCDEFGHIJ.XYZ /* Syntactically invalid name,
 /* because a qualifier is longer
 /* than 8 characters
CONTROL NOMSG /* Set OFF to suppress any SYSDSN
 /* TSO/E messages
WRITE VALUE RETURNED BY SYSDSN ==> &SYSDSN(&DSNAME)
EXIT CODE(0)
```

---

## Locating One Character String Within Another - &SYSINDEX

Use the &SYSINDEX built-in function to locate the position where one character string begins within another character string. In other words, &SYSINDEX returns the numeric index (or offset) of *string\_1* within *string\_2*. If &SYSINDEX does not find *string\_1* within *string\_2*, &SYSINDEX returns a value of zero.

Use the following syntax:

```
&SYSINDEX(string_1,string_2[,start])
```



## Locating String Within Another - &SYSINDEX

where:

*string\_1*

is the character string that you are searching for.

*string\_2*

is the character string to be searched in.

*start* is a numeric expression indicating where in *string\_2* the search for *string\_1* should begin. If omitted or zero, this value defaults to one.

In examples 1-4, assume that &X is DOG, &Y is CATDOGSDOG and &Z is 2:

1. SET A = &SYSINDEX(&X,&Y) /\* result: A = 4  
&SYSINDEX found DOG in the fourth position of CATDOGSDOG, thus the index is 4.
2. SET A = &SYSINDEX(&X,&Y,&Z) /\* result: A = 4  
&SYSINDEX started searching at the second position, and found DOG again at the fourth position.
3. SET A = &SYSINDEX(&X,&Y,3+&Z) /\* result: A = 8  
Because the search started in the fifth position (3+2) &SYSINDEX found the second occurrence of DOG, in the eighth position.
4. SET A = &SYSINDEX(&X,&Y,9) /\* result: A = 0  
The search started in the ninth position and &SYSINDEX could not find the target string DOG.

Blanks are valid in *string\_1* and *string\_2*. For example:

```
SET A = &SYSINDEX(is full,the car is full) /* result: A = 9
```

To search for a blank in *string\_2*, you can set *string\_1* to a variable containing the value &STR( ). For example:

```
SET BLANK = &STR()
SET TARG = THIS IS A TEST
SET LOC = &SYSINDEX(&BLANK,&TARG) /* result: &LOC = 5
```

If *string\_1* or *string\_2* might contain a comma or right parenthesis, first set the string to a variable's value using &STR, then use the variable in &SYSINDEX, again enclosed in &STR(...). For example:

```
SET ARG = &STR(,)
SET TARG = &STR((80,60))
SET &LOC = &SYSINDEX(&STR(&ARG),&STR(&TARG)) /* result: &LOC = 4
```

```
SET ARG = &STR()
SET TARG = &STR((80,60))
SET &LOC = &SYSINDEX(&STR(&ARG),&STR(&TARG)) /* result: &LOC = 7
```

## Using &SYSINDEX with DBCS Strings

&SYSINDEX can search for strings that contain characters of the double-byte character set (DBCS). The following considerations apply:

- Always include DBCS delimiters around DBCS characters in *string\_1* and *string\_2*. For example, using < and > to denote the DBCS delimiters X'0E' (shift-out) and X'0F' (shift-in):

```
SET A = &SYSINDEX(<d2>,<d1d2d3>) /* result: A = 2
```

- *String\_1* and *string\_2* can have EBCDIC, DBCS, or mixed data. For example:

```
SET X = &SYSINDEX(CD,A<d1d2>BCD) /* result: X = 5
SET X = &SYSINDEX(<d2>,<d1d2>BCD) /* result: X = 3
```

## Locating String Within Another - &SYSINDEX

EBCDIC and DBCS strings never match, even when they have the same hexadecimal values. For example:

```
SET X = &SYSINDEX(AB,<d1d2d3>) /* result: X = 0
/* where EBCDIC characters 'AB' and a DBCS character 'd2'
/* have the same hexadecimal value.
```

- Contiguous shift-out/shift-in delimiters and contiguous shift-in/shift-out delimiters in *string\_1* are treated as parts of the target. For example:

```
SET X = &SYSINDEX(<d1><d2>,A<d1><d2>B) /* result: X = 1
SET X = &SYSINDEX(<d1><d2>,A<d1d2>B) /* result: X = 0
```

- If *string\_1* consists of DBCS delimiters only, they are searched for in *string\_2*, and the result is the position of the character following the delimiters. For example:

```
SET X = &SYSINDEX(<>,A<>BCD) /* result: X = 3
```

---

## Limiting the Level of Symbolic Substitution - &SYSNSUB

Use the &SYSNSUB built-in function to limit the number of times a CLIST performs symbolic substitution in a statement. With &SYSNSUB, you can limit the CLIST to from 0 to 99 levels of substitution.

&SYSNSUB has the following syntax:

```
&SYSNSUB(level,expression)
```

where:

*level*

is a positive whole number, or a symbolic variable that resolves to a positive whole number, from 0 to 99. This number tells the CLIST how many levels of symbolic substitution to perform on the expression. The level parameter cannot contain other built-in functions or expressions.

*expression*

is a CLIST expression whose level of symbolic substitution is to be controlled, and whose final value is to be frozen without further evaluation of any kind.

For example,

```
SET Y = 30 /* result: &Y contains 30
SET X = &&Y /* result: &X contains &Y
SET Z = &&X /* result: &Z contains &X
SET A = &SYSNSUB(2,&Z) /* result: &A contains &Y
```

As specified, the CLIST performs only two levels of substitution, substituting &X for &Z and then substituting &Y for &X. The CLIST *does not* continue and resolve &Y to 30, as it would without the &SYSNSUB limit.

You can use &SYSNSUB to override the rule for double ampersands, in which the CLIST removes the first ampersand and does no substitution of the remaining variable. &SYSNSUB counts removal of the first ampersand as one level of substitution, and allows substitution to continue until the value in the *level* parameter is reached.

For example:

```
SET X = 10 /* result: &X = 10
SET Y = &&X /* result: &Y = &X (rule for double &&)

SET Y = &SYSNSUB(2,&&X) /* result: &Y = 10 (&SYSNSUB overrides &&)
```

**Note:** The control variable &SYSSCAN restricts the levels of substitution that you can specify with &SYSNSUB. &SYSSCAN must contain a number greater than or equal to the number you specify in &SYSNSUB's level parameter.

---

## Converting DBCS Data to EBCDIC - &SYSONEBYTE

Use the &SYSONEBYTE built-in function to convert character strings from the double-byte character set (DBCS) to the EBCDIC character set. &SYSONEBYTE converts only DBCS characters that have EBCDIC equivalents: the DBCS blank (X'4040') and DBCS characters that begin with the value X'42'.

&SYSONEBYTE converts the DBCS characters that have EBCDIC equivalents by removing the first byte (X'40' or X'42'). The second byte, which remains, represents the character in EBCDIC.

&SYSONEBYTE places DBCS delimiters around DBCS characters that are not convertible (those that lack EBCDIC equivalents).

The following example represents a complete conversion from DBCS to EBCDIC:

```
SET X = &SYSONEBYTE(<d1d2d3d4>) /* result: X = ABCD
```

The following example represents a partial conversion from DBCS to EBCDIC, assuming that d5 and d6 do not start with X'42' and are not the hex blank (X'4040'):

```
SET X = &SYSONEBYTE(<d3d4d5d6d7d8>) /* result: X = CD<d5d6>EF
```

---

## Converting EBCDIC Data to DBCS - &SYSTWOBYTE

Use the &SYSTWOBYTE built-in function to convert EBCDIC characters to the double-byte character set (DBCS). The EBCDIC characters that can be converted are those with the hexadecimal equivalents X'40' and in the range from X'41' to X'FE'. Any other EBCDIC characters cause errors when used with &SYSTWOBYTE.

&SYSTWOBYTE converts the EBCDIC characters to DBCS by prefixing them with the value X'42'. In the case of the EBCDIC blank (X'40'), &SYSTWOBYTE prefixes it with the value X'40' to create the DBCS blank.

&SYSTWOBYTE encloses the resulting DBCS strings in DBCS delimiters (X'0E' and X'0F').

The following example represents a complete conversion from EBCDIC to DBCS:

```
SET X = &SYSTWOBYTE(ABCD) /* result: X = <dAdBdCdD>
```

The following example represents a partial conversion from EBCDIC to DBCS:

```
SET X = &SYSTWOBYTE(CD<d5d6>EF) /* result: X = <dCdDd5d6dEdF>
```

## Converting EBCDIC Data to DBCS - &SYSTWOBYTE

---

## Chapter 7. Structuring CLISTS

|                                                                                                         |    |
|---------------------------------------------------------------------------------------------------------|----|
| Making Selections . . . . .                                                                             | 66 |
| The IF-THEN-ELSE Sequence . . . . .                                                                     | 66 |
| The Standard Format . . . . .                                                                           | 66 |
| The Null ELSE Format . . . . .                                                                          | 67 |
| The Null THEN Format . . . . .                                                                          | 67 |
| Nesting IF-THEN-ELSE Sequences . . . . .                                                                | 67 |
| The SELECT Statement . . . . .                                                                          | 68 |
| Using SELECT without a Test Expression (Simple SELECT) . . . . .                                        | 68 |
| Using SELECT with a Test Expression (Compound SELECT) . . . . .                                         | 68 |
| Distinguishing WHEN Clauses from WHEN Commands . . . . .                                                | 69 |
| Distinguishing the SELECT Statement from the RACF SELECT<br>Subcommand . . . . .                        | 69 |
| Loops . . . . .                                                                                         | 70 |
| The DO-WHILE-END Sequence . . . . .                                                                     | 70 |
| The DO-UNTIL-END Sequence . . . . .                                                                     | 71 |
| The Iterative DO Sequence . . . . .                                                                     | 71 |
| Compound DO Sequences . . . . .                                                                         | 72 |
| Nesting Loops . . . . .                                                                                 | 73 |
| Distinguishing END Statements from END Commands or Subcommands<br>Using the CONTROL Statement . . . . . | 74 |
| Using the DATA-ENDDATA Sequence . . . . .                                                               | 75 |
| Subprocedures . . . . .                                                                                 | 75 |
| Calling a Subprocedure . . . . .                                                                        | 75 |
| Returning Information from a Subprocedure . . . . .                                                     | 76 |
| Using the RETURN CODE Statement . . . . .                                                               | 76 |
| Using the SYSREF Statement . . . . .                                                                    | 77 |
| Sharing Variables among Subprocedures . . . . .                                                         | 77 |
| Using the NGLOBAL Statement . . . . .                                                                   | 77 |
| Restricting Variables to a Subprocedure . . . . .                                                       | 78 |
| Considerations for Using Other Statements in Subprocedures . . . . .                                    | 78 |
| Using ATTN and ERROR statements in Subprocedures . . . . .                                              | 78 |
| Using CONTROL Statements in Subprocedures . . . . .                                                     | 78 |
| Using GOTO statements in Subprocedures . . . . .                                                        | 78 |
| Nesting CLISTS . . . . .                                                                                | 79 |
| Protecting the Input Stack from Errors or Attention Interrupts . . . . .                                | 79 |
| Global Variables . . . . .                                                                              | 80 |
| Exiting from a Nested CLIST . . . . .                                                                   | 80 |
| Using the END Command . . . . .                                                                         | 81 |
| Using the EXIT Statement . . . . .                                                                      | 81 |
| GOTO Statements . . . . .                                                                               | 81 |

A CLIST can be:

- A single list of commands and statements
- A series of short lists connected by statements indicating which list is to be executed next

When you create a CLIST as a series of short lists, you can connect the lists using structured programming techniques. In structured programming, you direct the flow of execution from list to list in a generally top-down sequence, from the highest to the lowest level of detail. At the lower levels of detail, the lists can be independent modules (subprocedures and nested CLISTS) containing common code that you can

## Structuring CLISTs

call from other parts of the CLIST. A structured CLIST helps you avoid repetitive code and is easier to read and maintain than an unstructured CLIST.

This chapter describes the structural elements of the CLIST language and how to use them to move from one list of commands and statements to another. Structural CLIST statements belong to the following categories:

- Selection
- Loops
- Calls to subprocedures
- Calls to other CLISTs

---

## Making Selections

To tell the CLIST which commands or statements to execute next, you can use the IF Statement or the SELECT statement. These statements combine each selection with a test; if the test proves true, the CLIST executes the instructions, if not, the CLIST can execute alternative instructions.

## The IF-THEN-ELSE Sequence

The IF-THEN-ELSE sequence tests a condition or set of conditions, then determines the logical path of execution (action) based on the results of the test.

The *condition* must be either a comparative expression or a variable containing a comparative expression. You may code multiple conditions, in which case the comparative expressions (and/or variables) must be joined by logical operators.

The *action* can be one or more instructions. If the condition or set of conditions is true, the CLIST executes the instructions in the THEN action. If the condition or set of conditions is false, the CLIST executes the instructions in the ELSE action.

### The Standard Format

The standard format includes actions for both true and false conditions, for example:

```
IF condition THEN action ELSE action
```

If an action involves more than one statement or command, it is necessary to enclose the action in a DO-END sequence, for example:

```
IF condition THEN +
DO
:
:
(action) /* action consists of a list of statements or commands
:
:
END
ELSE action /* action consists of a single statement or command
```

For example, assume a CLIST optionally prints a data set it has updated based on user input. Assume the CLIST has prompted the user to determine whether to print the data set and has saved the response in a variable called &PRINT; The following IF-THEN-ELSE sequence performs the desired processing:

```
/******
/* If the user wants data set printed, issue a message */
/* saying that it is being printed and issue the command */
/* that prints it. If user does not want data set printed */
/* just issue a message saying that the data set is not */
/* being printed. */
/******
```

```

IF &PRINT=YES THEN +
DO
 WRITE We are printing the data set as you requested.
 printds da(&dsn)
END
ELSE +
 WRITE The data set will not be printed.

```

When there is only one instruction in an action, you may place the instruction on the same line as the THEN or ELSE statement. For example, you could code the ELSE statement in the previous example as follows:

```
ELSE WRITE The data set will not be printed.
```

### The Null ELSE Format

When a specific ELSE action is not required, you can code a null ELSE clause in one of two ways: omit the ELSE clause entirely or just code ELSE without operands (an action). The following IF-THEN-ELSE sequence omits the ELSE entirely:

```

IF &PRINT=YES THEN +
DO
 WRITE We are printing the data set as you requested.
 printds da(&dsn)
END

```

You can also code the following:

```

IF &PRINT=YES THEN +
DO
 WRITE We are printing the data set as you requested.
 printds da(&dsn)
END
ELSE

```

### The Null THEN Format

Assume a CLIST prints a data set itself and does not have to invoke another CLIST to do the printing. By coding a condition that is true when the data set should not be printed, you define a null THEN clause that effectively branches to the end of the ELSE clause, avoiding the code that prints the data set.

The following IF-THEN-ELSE sequence bypasses the printing action when &PRINT=NO; (If &PRINT has any other value, such as YES or null, then printing is performed.)

```

IF &PRINT=NO THEN
ELSE +
DO
 :
 :
 (The rest of the CLIST, which prints the data set)
 :
 :
END

```

## Nesting IF-THEN-ELSE Sequences

IF-THEN-ELSE sequences can contain other (*nested*) IF-THEN-ELSE sequences. For example, the following IF-THEN-ELSE sequence uses a nested IF-THEN-ELSE sequence as the action of its ELSE clause:

```

IF condition1 THEN +
DO
 action1 /* Do if condition 1 is true
END
ELSE +
 IF condition2 THEN +
 DO
 action2 /* Do if condition1 is false and

```

## Making Selections

```
END /* condition2 is true
ELSE +
DO
 action3 /* Do if condition1 and condition2
END /* are both false
```

Nested IF-THEN-ELSE sequences allow you to control the flow of processing under very precise conditions. However, multiple nested IF-THEN-ELSE sequences can be difficult to write and maintain. As an alternative, you can use the SELECT statement in many cases.

## The SELECT Statement

In situations where you might want to use multiple IF-THEN-ELSE statements, you can often use a single SELECT statement instead. The SELECT statement allows a CLIST to select actions from a list of possible actions. An action consists of one or more statements or commands. The SELECT statement has the following syntax, ending with the END statement. You can use the SELECT statement with or without the initial test expression.

```
SELECT [test expression]
 WHEN expression1
 :
 (action)
 :
 WHEN expression2
 WHEN expression3

 [OTHERWISE]
 :
 (action)
 :
END
```

### Using SELECT without a Test Expression (Simple SELECT)

If you omit the test expression from the SELECT statement, the CLIST tests the WHEN expressions in sequence for a true value. If a true value is found (for example,  $1 = 1$ ) the CLIST executes the action of that WHEN clause only. Then the CLIST passes control to the END statement. If none of the expressions evaluate to a true value, the CLIST executes the OTHERWISE action, if any.

For example, the following SELECT statement selects an action based on a return code from previous processing:

```
SELECT
 WHEN (&RTNCODE = 0) CALL 'A.B.LOAD(PGM)'
 WHEN (&RTNCODE = 1) +
 DO
 SET &X = X + 1
 SET RETRY = &STR(YES)
 END
 OTHERWISE SET &MSG = &STR(SEVERE ERROR)
END
```

For other examples of using the simple SELECT statement, see Figure 6 on page 107 and Figure 26 on page 138.

### Using SELECT with a Test Expression (Compound SELECT)

If you include a test expression on the SELECT statement, the CLIST compares the test expression to the expressions on the WHEN clauses. On each WHEN clause, you can specify multiple expressions, or a range of values by using a colon (:)



## Making Selections

between the low and high values in the range. You can combine expressions and ranges on a WHEN clause by using the operator OR or |.

If a test expression matches a value or falls within a range of values in a WHEN expression, the CLIST executes the action for that WHEN clause, then passes control to the END statement.

For example, in the following SELECT statement, the CLIST executes the action of the first WHEN clause because the test expression (5) falls within the range of values 4:6 on that WHEN clause:

```
SELECT 5
 WHEN (3 | 7 | 4:6) action...
 WHEN (9 | &A + &Z) action...
END
```

If no WHEN expressions satisfy the test expression, the CLIST executes the OTHERWISE action, if any.

For example, the following CLIST uses a SELECT statement to invoke other CLISTS that print quarterly reports. The CLIST bases its selection on a test expression (the number of the month) that the invoker supplies. When the number of the month falls within a certain range, the CLIST prints the appropriate report. Otherwise, the CLIST writes an error message.

```
PROC 1 MONTH
SELECT (&MONTH)
 WHEN (1:3) %FIRSTQTR
 WHEN (4:6) %SECNDQTR
 WHEN (7:9) %THIRDQTR
 WHEN (10:12) %FORTHQTR
 OTHERWISE WRITE The month must be a number from 1 to 12.
END
```

### Distinguishing WHEN Clauses from WHEN Commands

The WHEN clause in a SELECT statement is syntactically distinct from the WHEN SYSRC TSO/E command. In a SELECT statement, a left parenthesis must follow a WHEN clause. If you want to use the WHEN command as part of an action in a SELECT statement, enclose the WHEN command in a DO-END sequence to prevent the SELECT statement from interpreting the command as a not valid WHEN clause. For example, the following syntax is acceptable:

```
SELECT
 WHEN (&X=1) +
 DO
 WHEN SYSRC(= 8) TIME /* The action of the WHEN clause */
 END /* is the WHEN SYSRC TSO command. */
END /* End of the DO group */
END /* End of the SELECT statement */
```

For more information about using the WHEN SYSRC TSO/E command, see *z/OS TSO/E Command Reference*.

### Distinguishing the SELECT Statement from the RACF SELECT Subcommand

If, in a CLIST, you invoke the SELECT subcommand of the RACF command RACFRW, you must distinguish the subcommand from the SELECT statement. To do so, use the &STR built-in function. For example, you could specify the subcommand name as follows:

```
RACFRW
&STR(SELECT) VIOLATIONS
```

---

## Loops

Unlike the simple DO-END sequence, the other DO-sequences in the CLIST language create loops. Loops are lists of statements or commands that can be executed one or more times or not at all, depending on conditions that you specify in the loop. A CLIST executes a loop as many times as the conditions dictate. When the conditions are satisfied or no longer true, execution continues at the instruction after the loop.

The following sections describe how to create loops with the DO statement.

### The DO-WHILE-END Sequence

The DO-WHILE-END sequence creates a loop that executes while a specified condition is true. If the condition is not true, the loop does not execute.

To use the DO-WHILE-END sequence, code:

```
DO WHILE condition
 :
 : (action)
 :
END
```

The *condition* must be either a comparative expression or a variable containing a comparative expression. You can code multiple conditions by joining expressions and/or variables with logical operators.

The *action* can be one or more instructions. The CLIST executes the instructions within the sequence repeatedly *while* the condition on the WHILE clause is true. When the condition is false, the CLIST executes the next instruction after the END statement.

For example, you can initialize a variable (usually a counter) before the sequence and include it in the conditional expression. Then, you can modify the variable in the action so that eventually the condition is false.

For example, to process a set of instructions five times, you can code the following:

```
SET &COUNTER = 5 /* Initialize counter */
/* Perform the action while counter is greater than 0 */
DO WHILE &COUNTER > 0
 :
 : (Set of instructions)
 :
 SET COUNTER = &COUNTER - 1 /* Decrease counter by 1 */
END
```

The variable &COUNTER is a loop counter initially set to a value of five. WHILE tests the value of this counter each time the CLIST begins to execute the DO-WHILE-END sequence. As long as the value of &COUNTER is greater than zero (the test condition is true), the CLIST executes the sequence, whose last instruction decreases the counter's value by one. When the counter's value reaches zero (the test condition is false), the CLIST ends the loop, and continues processing at the instruction following the END statement.

If an error occurs in a DO-WHILE sequence, execution stops. In previous releases, a warning message was issued and execution continued, with the DO-WHILE sequence treated as a simple DO-END sequence.

## The DO-UNTIL-END Sequence

The DO-UNTIL-END sequence creates a loop that executes at least once and continues until a specified condition is true.

To use the DO-UNTIL-END sequence, code:

```
DO UNTIL condition
 ⋮
 (action)
 ⋮
END
```

The *condition* must be either a comparative expression or a variable containing a comparative expression. You can code multiple conditions by joining expressions and/or variables with logical operators.

The *action* can be one or more instructions. The CLIST executes the instructions within the sequence once, then tests whether the condition on the UNTIL clause is true. If the condition is false, the CLIST repeats the loop *until* the condition is true. When the condition is true, the CLIST ends the loop and executes the next instruction after the END statement.

For example, to repeat some instructions until a condition is true, you can code the following:

```
DO UNTIL &INPUT = YES /* Perform action until condition is YES
 ⋮
 (action)
 ⋮
 WRITE Type YES if you are finished
 READ &INPUT;
END
```

The DO UNTIL sequence is useful for requesting input from a user. Because the decision is made *after* the input is received, the loop can continue or end depending on the value of the input.

## The Iterative DO Sequence

The iterative DO sequence creates a loop that executes as long as a numeric value stays within a given range of values. The values can be variables derived from CLIST processing. The iterative DO sequence has the following structure:

```
DO variable = from_expression TO to_expression +
[BY by_expression]
 ⋮
 (action)
 ⋮
END
```

where:

*variable*

is the control variable for the loop. Its value changes each time the loop executes, increasing by one (the default) or by a value that you specify in the BY expression.

*from\_expression*

is a decimal integer, or an expression that evaluates to a decimal integer, from which the control variable starts. The CLIST sets the control variable to this value when the loop begins.

## Loops

### *to\_expression*

is a decimal integer, or an expression that evaluates to a decimal integer, that the control variable must increase or decrease to. The CLIST executes the loop as long as the value of the control variable stays within the range created by the FROM and TO expressions.

### *by\_expression*

is a decimal integer, or an expression that evaluates to a decimal integer, by which the control variable increases or decreases. The default value is one. After the loop executes, the control variable increases or decreases by this amount. If the control variable is no longer within the FROM-TO range, execution continues at the instruction after the END statement.

For example, a CLIST would execute the following loop ten times:

```
DO &count = 1 to 10 /* using default BY, increase &count by one
 /* each time through the loop
 :
 :
END /* &count is now equal to 11
```

And a CLIST would execute the following loop five times:

```
DO &count = 1 TO 10 BY 2 /* increase &count by two
 /* each time through the loop
 :
 :
END /* &count is now equal to 12
```

The FROM, TO, and BY expressions can all contain CLIST variables:

```
DO &count = &min TO &max BY &increment
 :
 :
END
```

## Compound DO Sequences

The preceding sections describe different ways to control the execution of loops. You can combine these different types of loop control in a compound DO sequence. A compound DO sequence combines an iterative DO sequence with a DO-WHILE and/or DO UNTIL sequence.

In a compound DO sequence, the iterative DO sequence comes first, followed by either the DO-WHILE or DO-UNTIL sequence:

```
DO variable = from_exp TO to_exp BY by_exp +
WHILE condition1 +
UNTIL condition2 +
 :
 (action)
 :
END
```

The CLIST executes the compound DO sequence as shown in Figure 2 on page 73.

The following example demonstrates a possible compound DO sequence:

```
SET &increment = 2 /* Initialize BY condition
SET &year = 87 /* Initialize WHILE condition
DO &count = 1 TO 10 BY &increment +
WHILE &year=87 UNTIL &input=YES;
 :
 (action)
```

```

:
WRITE Type YES if you are finished
READ &INPUT;
END

```

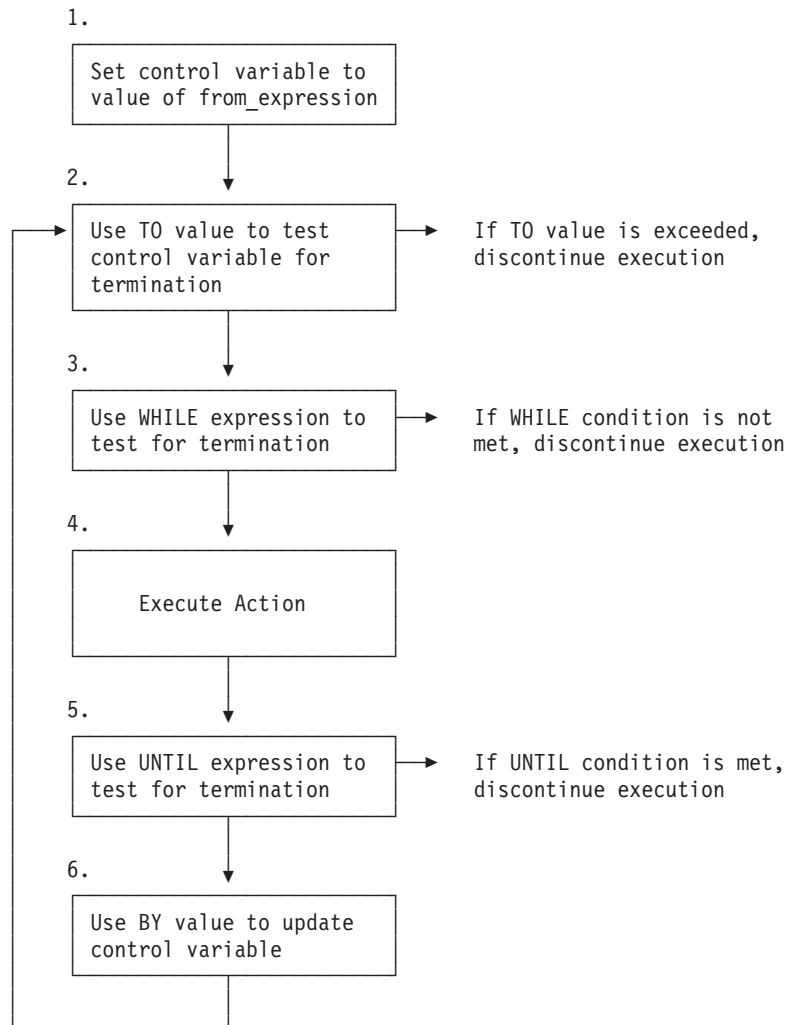

Figure 2. How a CLIST Executes a Compound DO Sequence

If you want a WHILE or UNTIL expression to contain a return code from the action of the DO sequence, obtain the return code from &LASTCC and store it into another variable as part of the action. For example:

```

DO &I = 1 to 10 WHILE (&RCODE = 0)
:
SET RCODE = &LASTCC
END

```

## Nesting Loops

The action of a loop can contain other loops. Loops within loops are called nested loops. Loops can contain nested loops of the same type or of a different type.

## Loops

Nested loops of the same type are often iterative DO-loops within other iterative DO-loops. For example, to execute 100 CLISTs named PROC00 through PROC99, you could code:

```
DO &I = 0 to 9
 DO &J = 0 to 9
 %proc&I&J
 END
END
```

Nested loops of a different type are often DO-UNTIL loops within DO-WHILE loops, for example:

```
SET &COUNTER1 = 0 /* Initialize outer loop counter */
SET &COUNTER2 = 3 /* Initialize nested loop counter */
DO WHILE &COUNTER1 < 5
 /* Perform action while &counter1 is less than 5 */
 :
 (action) /* Executes 5 times */
 :
DO UNTIL &COUNTER2 = 0
 /* Perform action until &counter2 is equal to 0 */
 :
 (Subset of action) /* Executes 3 times */
 :
 SET COUNTER2 = &COUNTER2 - 1 /* Increase nested loop counter by 1 */
END
:
SET COUNTER1 = &COUNTER1 + 1 /* Increase outer loop counter by 1 */
END
```

## Distinguishing END Statements from END Commands or Subcommands

You can issue TSO/E END commands or subcommands in a CLIST. The END command terminates the CLIST, and END subcommands terminate certain commands, such as the TEST command. When you include TSO/E END commands or subcommands in the action of a DO-sequence or a SELECT statement, you must distinguish the END commands or subcommands from the END statement. You can distinguish the END statement using the CONTROL statement or the DATA-ENDDATA sequence.

### Using the CONTROL Statement

One way to distinguish an END statement from an END command or subcommand is by coding a CONTROL statement with the END operand. The value you code for the END operand must then be substituted for the END statement anywhere in the CLIST, unless another CONTROL END overrides the value.

For example, if you want to substitute ENDO for the END statement, you can code the following:

```
CONTROL END(ENDO)
SET COUNTER = 10
DO WHILE &COUNTER GT 0
 :
 (action)
 :
 test datapak(newpgm) /* Issue TSO/E TEST command */
 :
 (TEST subcommands)
 :
 end /* Issue END subcommand of TSO/E TEST */
END
```

```

:
: (more action)
:
SET COUNTER = &COUNTER - 1 /* Decrease counter by 1 */
ENDO

```

### Using the DATA-ENDDDATA Sequence

Another way to identify END commands or subcommands in DO-sequences or SELECT statements, is to place them in a DATA-ENDDDATA sequence. For example:

```

SET COUNTER = 10
DO WHILE &COUNTER GT 0
:
: (action)
:
DATA
test datapak(newpgm) /* Issue TSO/E TEST command */
:
: (TEST subcommands)
:
end /* Issue END subcommand of TSO/E TEST */
ENDDDATA
:
: (more action)
:
SET COUNTER = &COUNTER - 1 /* Decrease counter by 1 */
END

```

Only TSO/E commands and subcommands can appear within the DATA-ENDDDATA sequence. If a CLIST statement is included, TSO/E attempts to execute it as a TSO/E command, causing an error. For more information about the DATA-ENDDDATA sequence, see “Coding Responses to Prompts - The DATA PROMPT-ENDDDATA Sequence” on page 85.

---

## Subprocedures

A subprocedure is a part of a CLIST that you can call from one or more places in a CLIST. With subprocedures, you can organize a CLIST into logical units, making the CLIST easier to write and maintain. You can also keep common code in a single location and call it from other parts of the CLIST, thus avoiding repetitive code.

Subprocedures offer a variety of ways to communicate information within a CLIST. You can:

- Pass parameters to and from subprocedures, for reference or modification
- Share variables globally among subprocedures
- Isolate variables in a subprocedure from the rest of the CLIST

## Calling a Subprocedure

You call a subprocedure using the SYSCALL statement. On the SYSCALL statement, name the subprocedure and any parameters you want to pass to the subprocedure. The parameters can be data strings, variable values, or variable names.

For example, the following CLIST uses the SYSCALL statement to pass a data string (Jones), a variable value (&A), and a variable name (B) to a subprocedure (XYZ):

```

SET &A = AL
SET &B = Jr.
SYSCALL XYZ Jones &A B /* pass parameters to XYZ */

```

## Subprocedures

```
XYZ: PROC 3 PARM1 PARM2 PARM3 /* receive parameters on PROC stmt */
 SYSREF PARM3 /* indicate parm3 holds a var. name */
 WRITE &PARM1, &PARM2 &PARM3 /* result: JONES, AL Jr. */
END
```

Subprocedures always begin with a labeled PROC statement. The label can consist of 1-31 characters (A-Z, 0-9, #, \$, @) beginning with an alphabetic character (A-Z). In the example above, the label is XYZ; the number 3 on the PROC statement indicates that the subprocedure receives 3 positional parameters; those parameters are assigned to the variables PARM1, PARM2, and PARM3. For more information about the PROC statement, see “PROC Statement” on page 171.

The SYSREF statement tells the CLIST that PARM3 contains the name of a variable (B). The SYSREF statement allows other statements in subprocedure to reference and modify the variable’s value (Jr.). For more information, see “Using the SYSREF Statement” on page 77.

To pass a parameter containing blanks to a subprocedure, set a variable equal to the parameter value, then refer to that variable (without the ampersand) using &STR on the SYSCALL statement. In the subprocedure, use the SYSREF statement to refer to the PROC statement parameter that corresponds to the variable name passed on the SYSCALL statement. For example,

```
SET &A = JOHN AL
SYSCALL XYZ &STR(A) /* Pass variable to XYZ, omitting & from
 /* the variable name
 :
XYZ: PROC 1 PARM /* Subprocedure XYZ
 SYSREF &PARM /* indicate PARM holds a variable name
 WRITE &PARM /* result: JOHN AL
```

Subprocedures must always end with the END statement. When subprocedures end, they pass control back to the statement following the SYSCALL statement.

Subprocedures can use the SYSCALL statement to:

- Call other subprocedures and pass parameters to them
- Call themselves
- Call the CLIST’s main procedure, if it has a label

## Returning Information from a Subprocedure

Subprocedures can return information to the caller using:

- Return codes
- SYSREF variables
- NGLOBAL variables

### Using the RETURN CODE Statement

Subprocedures can return information to the caller using the CODE option of the RETURN statement. Like return codes from TSO/E commands, return codes from subprocedures are stored in the control variable &LASTCC, but error return codes from subroutines will not cause an error routine to receive control.

In the following example, the subprocedure passes a return code to the statement following SYSCALL:

```
SET &A = AL
SYSCALL XYZ &A /* pass variable &A to XYZ */
IF &LASTCC = 0 THEN +
 WRITE A11's We11!
```



```
XYZ: PROC 1 PARM1
 WRITE &PARM1
 RETURN CODE(0)
END
```

### Using the SYSREF Statement

When a SYSCALL statement passes a variable name (without the ampersand), the subprocedure can use a SYSREF statement to let following statements reference and modify the variable's value. All changes to a SYSREF variable are retroactive; that is, the new values are assigned to the original variable back in the caller.

In the following example, the subprocedure gives a new value to the variable whose name is passed (A). The new value (GEORGE) replaces the old value (AL) in the caller.

```
 SET &A = AL
 SYSCALL XYZ A /* pass var. &A to XYZ, omitting the &*/;
 IF &LASTCC = 0 THEN +
 WRITE &A /* result: GEORGE

XYZ: PROC 1 &PARM1
 SYSREF &PARM1 /* refer changes to the caller */
 SET &PARM1 = GEORGE
 RETURN CODE(0)
END
```

Reminder: For SYSREF variables, always omit the ampersand (&) from corresponding variables on the SYSCALL statement. By omitting the ampersand on SYSCALL, you pass the name of the variable, not its value, to the subprocedure. Using the SYSREF statement, the subprocedure can then assign new values to the variable.

## Sharing Variables among Subprocedures

In addition to passing return codes and variable values, you can define common variables to be shared among different CLISTS, or among subprocedures in a single CLIST.

Variables shared among different CLISTS are called GLOBAL variables. GLOBAL variables are defined using the GLOBAL statement, and are fully described in "Nesting CLISTS" on page 79.

Variables shared by subprocedures in one CLIST are called NGLOBAL (named global) variables. You define named global variables with the NGLOBAL statement. When you define an NGLOBAL variable, any subprocedure in the same CLIST can refer to it by name and modify its value.

The NGLOBAL variables differ from GLOBAL variables in that:

- They are not global to (shared with) other CLISTS.
- They are defined by name only (not position).
- They need to be defined only once.

### Using the NGLOBAL Statement

The NGLOBAL statement names variables that all the subprocedures in a CLIST can use. The following subprocedure (ABC) defines variables A, B, and C and uses the NGLOBAL statement to make them available to other subprocedures in the CLIST:

```
ABC: PROC 0 /* In subprocedure ABC,
 NGLOBAL A,B,C /* define NGLOBAL variables
 SET A = apples
```

## Subprocedures

```
SET B = bananas
SET C = cantaloup
SYSCALL XYZ /* call subprocedure XYZ
END

XYZ: PROC 0 /* In subprocedure XYZ,
WRITE Mix &A, &B, and &C /* use the NGLOBAL variables
END
```

The NGLOBAL statement must precede any statement that uses its variables. The number of variables that you can name on the NGLOBAL statement is unlimited.

For another example of using the NGLOBAL statement with subprocedures, see “Allocating a Data Set with LISTDSI Information - The EXPAND CLIST” on page 146.

## Restricting Variables to a Subprocedure

Variables that you define in a subprocedure are local to that subprocedure, unless you specifically name them on a GLOBAL or NGLOBAL statement. Different subprocedures in a CLIST can have variables with the same name, and each variable is local to the subprocedure that defined it. Therefore, when you define a variable, you don't have to check to see if that name has been used in the CLIST before.

## Considerations for Using Other Statements in Subprocedures

Some CLIST statements require special consideration when used in subprocedures. The following sections describe these statements and considerations.

### Using ATTN and ERROR statements in Subprocedures

Subprocedures can have their own attention and error routines. These are routines that receive control when the CLIST user presses the attention key on a terminal keyboard, or an error occurs. See Chapter 10, “Writing ATTN and ERROR Routines” on page 101 for a full description of these routines, including special considerations for using them with subprocedures. For example, a subprocedure's attention or error routine cannot contain a nested attention or error routine.

When a subprocedure receives control, the caller's attention and error routines remain in effect until the subprocedure issues an ATTN or ERROR statement. Then the subprocedure's attention or error routine prevails until the routine is turned off or replaced, or the subprocedure ends. When the subprocedure ends, the caller's attention and error routines take control again.

### Using CONTROL Statements in Subprocedures

CLISTs can establish special conditions by issuing the CONTROL statement and certain control variables. These conditions, comprising a CONTROL environment, remain in effect when you call a subprocedure. Subprocedures can set up their own CONTROL environment, but it only applies to the subprocedure and any subprocedures it calls. When a subprocedure ends, the caller's CONTROL environment takes effect again.

### Using GOTO statements in Subprocedures

If you use a GOTO statement in a subprocedure, it can only branch to labels in the same subprocedure. Also, GOTO statements cannot branch to PROC statements.

## Nesting CLISTS

A CLIST can invoke another CLIST, which in turn can invoke another, and so forth. CLISTS that are invoked by other CLISTS are called nested CLISTS. When a nested CLIST ends, it automatically branches back to the statement following the one that invoked it. You can define global variables that allow nested CLISTS to communicate with each other.

You can structure a series of nested CLISTS in levels. The CLIST invoked by the user is the top-level or outer-level CLIST in the nesting chain. CLISTS invoked by the outer-level CLIST are nested within it, and they may have lower-level CLISTS nested within them.

In Figure 3, PROC1 is the outer-level CLIST. It invokes PROC2 and then PROC3, which are nested within it. PROC2 invokes PROC4, and PROC4 invokes PROC5. PROC4 is nested within PROC2, and PROC5 within PROC4.

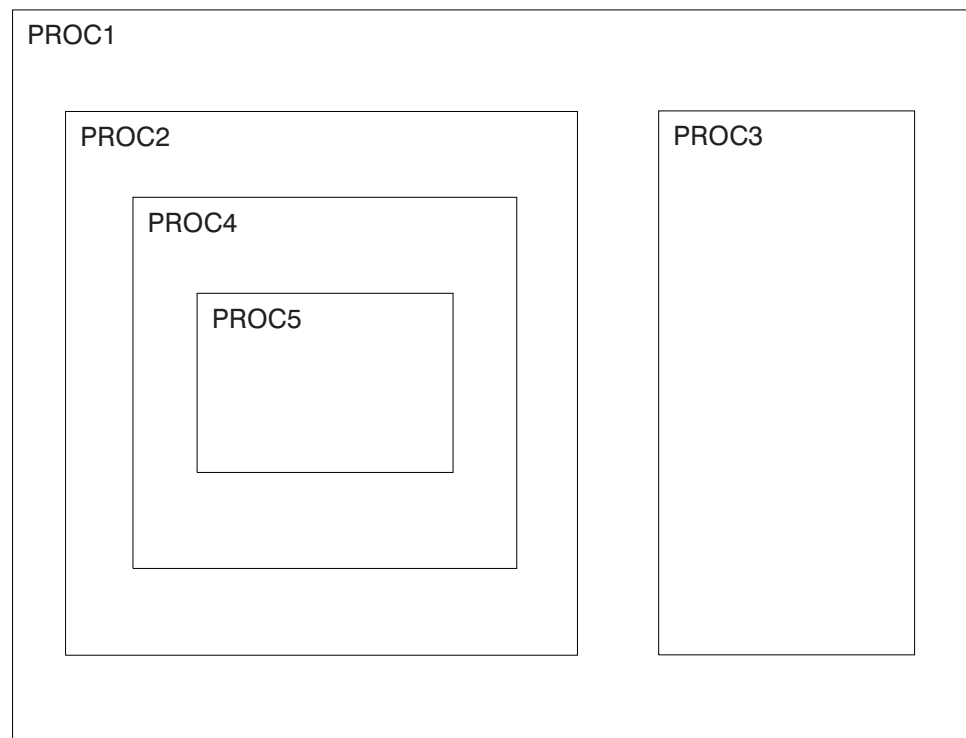

Figure 3. Nested CLISTS

Because CLISTS are executed sequentially, PROC1 cannot invoke PROC3 until PROC5, PROC4, and PROC2 finish processing.

The same CLIST can be invoked at two or more levels of a nested hierarchy because each invocation of a nested CLIST causes a new copy of it to be brought into storage. For example, PROC2 and PROC4 could both invoke PROC5.

## Protecting the Input Stack from Errors or Attention Interrupts

When a CLIST is executed, it translates each statement into an executable format and places it in a section of storage called the input stack. The input stack is the source from which TSO/E obtains its input (TSO/E commands and CLIST statements).

## Nesting CLISTS

For nested CLISTS, the input stack holds the contents of the CLISTS in the order in which they are nested.

You can protect the input stack from being erased (flushed) when an error or attention interrupt occurs. To protect the input stack, code the CONTROL statement with the NOFLUSH or MAIN operand at the beginning of a CLIST that you want to receive control when an error or attention interrupt occurs.

Any options established by a nested CLIST are in effect only when that nested CLIST is executing. In particular, a nested CLIST's CONTROL statement options and attention and error routines are no longer in effect when the nested CLIST returns control to its caller.

Nested CLISTS in the subcommand environment (those invoked under the EXEC subcommand of EDIT) can execute only subcommands and CLIST statements. They cannot execute TSO/E commands, nor can any nested CLISTS that they invoke, until the END subcommand is executed.

## Global Variables

Global variables are variables defined on a GLOBAL statement. They allow communication between nested CLISTS. Any CLIST in the nested chain can modify or reference the value of a global variable.

All global variables in a given CLIST must have unique names. You cannot have more global variables on the GLOBAL statement in a nested CLIST than there are on the GLOBAL statement in the top-level CLIST.

To establish global variables, first determine the total number of symbolic variables that are referenced by more than one of the CLISTS in the nested chain. (Include the top-level CLIST among those in the nested chain.) Then, code GLOBAL statements in each of the CLISTS in the chain that are involved in the passing of data.

For example, in Figure 3 on page 79, assume the following global variable definitions in each of the CLISTS:

```
In PROC1: GLOBAL A B C D
In PROC2: GLOBAL X Y Z
In PROC3: GLOBAL F G H K
In PROC4: GLOBAL Q
In PROC5: GLOBAL R S.
```

Variables &A, &X, &F, &Q, and &R can be shared by all the CLISTS. If PROC4 sets &Q equal to D777, then &A, &X, &F, and &R are also set equal to D777.

Within nested CLISTS, global variables are positional; that is, all variables defined first refer to the same variable; all variables defined second refer to the same variable; and so on.

## Exiting from a Nested CLIST

There are three ways to exit from a nested CLIST:

- Let control automatically return to the calling CLIST at the end of the nested CLIST.
- Issue an END command.

- Issue an EXIT statement.

### Using the END Command

The END command only allows you to terminate a CLIST. Control returns to the CLIST that invoked it, but you cannot set a return code. To use the END command, code:

```
end
```

The END command just terminates a CLIST and should not be used if a return code is to be passed back to a calling CLIST. A calling CLIST may find the return code in an unpredictable state. Use the EXIT statement where proper passing of a return code to a caller is required.

### Using the EXIT Statement

To cause a nested CLIST to return control to the CLIST that invoked it, you can also code:

```
EXIT
```

You can specify a return code on the EXIT statement. The return code provides a way for lower-level CLISTS to pass back to their callers indications of errors or successful execution. To pass a return code when you exit, code:

```
EXIT CODE(expression)
```

The expression must be a positive integer, zero, or a symbolic variable whose value, after substitution, is an integer. The nested CLIST stores the value of the expression into the control variable &LASTCC.

If an error or attention interrupt occurs, a nested CLIST can pass control back to a CLIST that is protected from termination by the CONTROL MAIN or CONTROL NOFLUSH options. To return control to such a CLIST, code:

```
EXIT QUIT
```

or

```
EXIT CODE(expression) QUIT
```

If a CLIST in the nested chain is protected from termination, execution continues based on actions in the CLIST's active error or attention routine. For information on writing error and attention routines, see Chapter 10, "Writing ATTN and ERROR Routines" on page 101.

If no CLIST in the nested chain is protected from being terminated after an error or an attention interrupt, coding QUIT causes control to return to the environment from which the CLIST was invoked: TSO/E, TSO/E EDIT mode, or ISPF.

---

## GOTO Statements

The GOTO statement causes an unconditional branch to a label within a CLIST. The label may be a variable whose value, after symbolic substitution, is a valid label within the CLIST. Examples of using GOTO statements are:

```
IF &A = 555 THEN GOTO A1
IF &A NE 0 THEN GOTO A2
A1: processing
 ⋮
 A2: processing
```

## GOTO Statements

```

:
SET TARGET = B1
IF &X = 777 THEN GOTO &TARGET
ELSE +
 DO
 SET TARGET = B2
 :
 IF LASTCC = 0 THEN +
 SET TARGET = B1
 GOTO &TARGET
 END
B1: processing
B2: processing
:

```

GOTO statements cannot branch:

- To another CLIST
- To a subprocedure's PROC statement
- From one subprocedure to another
- From a subprocedure to the CLIST's main procedure

---

## Chapter 8. Communicating with the Terminal User

|                                                                        |    |
|------------------------------------------------------------------------|----|
| Prompting the User for Input . . . . .                                 | 83 |
| Prompting with the PROC Statement . . . . .                            | 83 |
| Prompting with the WRITE and WRITENR Statements . . . . .              | 84 |
| Prompting with TSO/E Commands. . . . .                                 | 84 |
| Coding Responses to Prompts - The DATA PROMPT-ENDDATA Sequence         | 85 |
| Writing Messages to the Terminal . . . . .                             | 86 |
| Using the WRITE and WRITENR Statements. . . . .                        | 87 |
| Controlling the Display of Informational Messages . . . . .            | 87 |
| Receiving Responses from the Terminal . . . . .                        | 88 |
| Using the READ Statement . . . . .                                     | 88 |
| Controlling Uppercase and Lowercase for READ Statement Input . . . . . | 90 |
| Using the READDVAL Statement . . . . .                                 | 91 |
| Passing Control to the Terminal . . . . .                              | 92 |
| Returning Control After a TERMIN or TERMING Statement . . . . .        | 93 |
| Entering Input After a TERMIN or TERMING Statement . . . . .           | 93 |
| Using ISPF Panels . . . . .                                            | 94 |
| ISPF Restrictions . . . . .                                            | 94 |
| Sample CLIST with ISPF Panels . . . . .                                | 94 |

The CLIST language offers several ways to communicate with the terminal user. These methods are:

- Prompting the user for input
- Writing messages to the user
- Receiving replies from the user
- Passing control to the user
- Using ISPF panels

---

### Prompting the User for Input

A CLIST can prompt for input by:

- Using a PROC statement with positional or keyword parameters on the first line of the CLIST
- Using WRITE and WRITENR statements
- Using TSO/E commands

### Prompting with the PROC Statement

When you include positional parameters on a PROC statement at the beginning of a CLIST, the CLIST user must supply a value for each of them. If the user does not specify a value at execution, the CLIST prompts until the user specifies a value. For example, the PROC statement

```
PROC 2 NAME ADDRESS
```

requires the user to pass two positional parameters at execution, for example:

```
EX clistname 'Jones Fishville'
```

If the user does not pass a parameter, the CLIST prompts for a NAME and an ADDRESS. A PROC statement at the beginning of a CLIST also prompts when a user passes a keyword parameter without a required value. For example, the following PROC statement allows the user to pass the parameter ACCT with a value in parentheses:

## Prompting User for Input

```
PROC 0 ACCT()
```

If the user passes ACCT without a value, for example,  
EX clistname 'ACCT'

the CLIST prompts for a value.

Unlike PROC statements at the beginning of a CLIST, PROC statements on subprocedures do not prompt for missing parameters. For more information about the PROC statement, see “Using the PROC Statement” on page 20.

## Prompting with the WRITE and WRITENR Statements

You can use either a WRITE or WRITENR statement, or a combination of both, to send a message to the terminal user and prompt for input. To obtain input after a WRITE or WRITENR, use the READ statement. For details about how to use the WRITE and WRITENR statements, see “Using the WRITE and WRITENR Statements” on page 87.

## Prompting with TSO/E Commands

Some TSO/E commands, such as LISTDS, require more information than just the name of the command and they prompt when that information is not supplied. However, TSO/E commands included in a CLIST can prompt for input only when the CLIST allows prompting. Prompting in a CLIST is controlled by the TSO/E commands PROFILE and EXEC, and by the CLIST statement CONTROL and the control variable &SYSPROMPT.

The following table illustrates the effect on prompting using different explicit specifications of PROMPT/NOPROMPT on the PROFILE and EXEC commands and on the CONTROL statement. Note that SET &SYSPROMPT = ON has the same effect as CONTROL PROMPT and SET &SYSPROMPT = OFF has the same effect as CONTROL NOPROMPT.



| Specifications                                    | Prompting by TSO/E commands allowed in CLIST |    |
|---------------------------------------------------|----------------------------------------------|----|
|                                                   | YES                                          | NO |
| profile prompt<br>exec prompt<br>CONTROL PROMPT   | X                                            |    |
| profile prompt<br>exec noprompt<br>CONTROL PROMPT | X                                            |    |
| profile prompt<br>CONTROL PROMPT                  | X                                            |    |
| profile prompt<br>exec prompt                     | X                                            |    |
| profile noprompt<br>exec prompt<br>CONTROL PROMPT |                                              | X  |
| profile prompt<br>exec prompt<br>CONTROL NOPROMPT |                                              | X  |
| profile prompt<br>exec noprompt                   |                                              | X  |
| profile prompt                                    |                                              | X  |

**Notes:**

1. PROFILE PROMPT is the default specification and applies to a TSO/E session, not to a particular CLIST. You don't need to specify PROFILE PROMPT unless you want to override a prior PROFILE NOPROMPT command.
2. The PROFILE command can be executed either outside of, or within, a CLIST.
3. EXEC NOPROMPT is the default specification and applies only to the CLIST that it invokes.
4. The CONTROL statement applies only to the CLIST in which it appears.
5. If a CONTROL statement does not appear in a CLIST, CONTROL NOPROMPT is implied, unless &SYSPROMPT is set to a value of ON.

**Coding Responses to Prompts - The DATA PROMPT-ENDDATA Sequence**

If you execute a CLIST in the background, a user cannot respond to prompts from the CLIST. To avoid this problem, use the DATA PROMPT-ENDDATA sequence. The DATA PROMPT-ENDDATA sequence lets you designate responses to prompts by TSO/E commands or subcommands.

To use the DATA PROMPT-ENDDATA sequence, code:

```
DATA PROMPT
 ⋮
/* Responses */
ENDDATA
```

## Prompting User for Input

If the sequence is not immediately preceded by a TSO/E command or subcommand that prompts, an error occurs (error code 968 appears in control variable &LASTCC). You can ignore the error condition if a command or subcommand that *could* prompt, does not prompt.

The responses in the DATA PROMPT-ENDDATA sequence must appear exactly as if a user entered the response. Each DATA PROMPT-ENDDATA sequence can respond only to prompts issued by the immediately preceding command or subcommand. However, you can include multiple responses to satisfy multiple prompts. Excess responses can result in an error message and termination of the CLIST if an error routine is not present.

To stop TSO/E commands from prompting after a DATA PROMPT-ENDDATA sequence, code a null line after ENDDATA. To code a null line, first set a variable equal to null:

```
SET &abc =
```

Then place that variable on the line after ENDDATA:

```
ENDDATA
&abc
```

Some TSO/E commands prompt for input when you code certain operands. For example, the LINK command invokes the linkage editor. When you substitute an asterisk (\*) for the data set name, TSO/E prompts for control statements. If you include such a LINK command in a CLIST that might run in the background, place the control statements within a DATA PROMPT-ENDDATA sequence. The following CLIST, when run in the background, link-edits the member X, which resides in the file DD1:

```
CONTROL PROMPT LIST
IF &SYSENV=FORE THEN /* CLIST is running in the foreground */ +
 link (*) /* Prompt user for control statements */ +
 load('d32kds1.load') pr(*) ncal xref list let
ELSE /* CLIST is being run in the background */ +
 DO
 SET NULL = /* set null line to stop prompting after ENDDATA
 link (*) +
 load('d32kds1.load') pr(*) ncal xref list let
 DATA PROMPT /* Designate responses to prompts */
 include dd1(x)
 entry x
 name x
 ENDDATA
 &NULL /* null line stops prompting */
 END
```

There are additional considerations for using the DATA PROMPT-ENDDATA sequence:

- The CLIST must allow prompting.
- The CLIST performs symbolic substitution before using the responses to satisfy the prompt. (You can include variables in the responses.)

---

## Writing Messages to the Terminal

CLISTs send two types of messages to the terminal user: messages that you specifically write from the CLIST, and informational messages from commands or statements in the CLIST.

## Using the WRITE and WRITENR Statements

Two CLIST statements are available for sending messages to the terminal and prompting for input:

- WRITE displays a message at the terminal and causes the terminal's display cursor to return to the beginning of the next line after the message is displayed.
- WRITENR displays a message at the terminal and causes the terminal's display cursor to remain at the end of the message. (The "NR" in WRITENR is for "No Return".)

You can use either statement to send messages. You might find WRITENR preferable when the message prompts the user for input.

When prompting the user for input, include a READ statement after the WRITE or WRITENR statement. The READ statement *reads* the user input into a variable or variables. For more information, see "Using the READ Statement" on page 88.

Both WRITE and WRITENR must be followed by one or more blanks and the text of the message. For example:

```
CONTROL ASIS
:
WRITE Your previous entry was invalid.
WRITE Do you want to continue?
WRITENR Enter yes or no.
```

As a result of these statements, the terminal user sees the following messages on the screen:

```
Your previous entry was invalid.
Do you want to continue?
Enter yes or no. __
```

The cursor stops after the period in the last line to indicate the CLIST is waiting for the user's response. Because CONTROL ASIS is specified the CLIST displays the message 'as written', in both uppercase and lowercase letters.

You can also use the WRITENR statement to join text. For example:

```
CONTROL CAPS
:
WRITENR Please enter your userid
WRITE followed by two blanks.
```

As a result of these statements, the terminal user sees the following message:

```
PLEASE ENTER YOUR USERID FOLLOWED BY TWO BLANKS.
```

Because CONTROL CAPS is specified, the message is translated to all capital letters before being displayed.

## Controlling the Display of Informational Messages

You can request that informational messages from commands or statements in a CLIST be displayed or suppressed using operands on the CONTROL statement or the &SYSMSG control variable.

- To request that they be displayed, code:

```
CONTROL MSG
```

## Writing Messages to Terminal

or  
SET &SYSMSG = ON

- To suppress the display of informational messages, code:

CONTROL NOMSG

or  
SET &SYSMSG = OFF

The MSG/NOMSG option has no effect on error messages, they are always displayed.

---

## Receiving Responses from the Terminal

The READ and READDVAL statements provide two ways for CLISTs to access user input from the terminal. The READ statement obtains input directly from the terminal, usually following a WRITE or WRITENR statement. The READDVAL statement obtains input from the &SYSDVAL control variable.

### Using the READ Statement

The READ statement makes terminal input available to a CLIST in the form of symbolic variables. You normally precede a READ statement with one or more WRITE or WRITENR statements to let the user know that the CLIST is expecting input, and what sort of input it is expecting.

You can include one or more symbolic variables on a READ statement. If a READ statement does not include any variables, the CLIST stores the information the user enters into the control variable &SYSDVAL.

Assume that a WRITE statement requests that the user enter four names. The accompanying READ statement could be coded as follows:

```
READ A,B,C,D
```

Note that variables on a READ statement do not require ampersands.

If the user's response to the previous WRITE statement is:

```
SMITH,JONES,KELLY,INGALLS,GREENE
```

The CLIST assigns the names to the symbolic variables on the READ statement as follows:

```
&A has the value SMITH.
&B has the value JONES.
&C has the value KELLY.
&D has the value INGALLS.
```

Because the READ statement only includes four variables, the CLIST ignores the fifth name (GREENE).

You can also code READ statements without variables:

```
READ
```

If the user responded with the same five names, they would all be stored in the control variable &SYSDVAL. To preserve the input strings, the CLIST does not

## Receiving Responses from Terminal

remove the delimiters. For example, if the user responds to the previous READ statement by entering "SMITH,JONES,KELLY,INGALLS,GREENE", &SYSDVAL has the following value:

```
SMITH,JONES,KELLY,INGALLS,GREENE
```

To assign a null value to one of the variables on a READ statement, the user can enter either a double comma or a double apostrophe (two single quotes). For example, assume that the CLIST sends a message to the user requesting four numbers. The READ statement to obtain these numbers is:

```
READ NUM1,NUM2,NUM3,NUM4
```

If the user responds either:

```
15,24,,73
```

or

```
'15' '24' '' '73'
```

The symbolic variables on the READ statement then have the following values:

```
&NUM1 has the value 15.
&NUM2 has the value 24.
&NUM3 has a null value.
&NUM4 has the value 73.
```

The fact that single quotes are valid delimiters requires that you exercise care when reading *fully-qualified* data set names into variables. Precautions are necessary because, if the user enters the data set name within single quotes (according to TSO/E naming conventions), the CLIST normally reads them as delimiters, not data. If a WRITE statement requests the name of a fully-qualified data set, the CLIST can obtain the data set name as entered by the user, with single quotes preserved, by using the READ statement with the &SYSDVAL control variable.

The following CLIST uses a READ statement and &SYSDVAL to preserve single quotes around a data set name. It also checks for the quotes to see if the user entered a fully-qualified data set name and, if not, adds the quotes and the user's prefix to the name.

```
PROC 0
WRITE Enter the name of a data set.
READ
SET &DSN = &SYSDVAL /* Get name from &SYSDVAL; */
IF &SUBSTR(1:1,&DSN) = &STR(') THEN +
 DO /* If not fully qualified, */
 SET &DSN = '&SYSPREF;.&DSN' /* add prefix and quotes. */
 END
WRITE &DSN
```

You can also use the READ statement to obtain values for PROC statement keywords that were not supplied on the invocation of the CLIST. For example, suppose a PROC statement defines &ALPHA as a keyword with a default null value. Assume &ALPHA contains the number of golf balls on the moon and that the user does not assign a value to &ALPHA when invoking the CLIST. However, a variable, &SPACEVENTS, in the CLIST results in code being executed that requires a non-null value for &ALPHA. To obtain a value for &ALPHA, the following code sends a message to the user requesting a value for &ALPHA. Then, it issues a READ statement with &ALPHA as a parameter.

```
PROC 0 ALPHA()
 ⋮
 SET SPACEVENTS = &ALPHA
```

## Receiving Responses from Terminal

```
DO WHILE &SPACEVENTS = /* Null */
 WRITE Enter the number of golf balls there
 WRITE are on the moon. A null value is unacceptable.
 READ ALPHA
 SET SPACEVENTS = &ALPHA
END
```

If a user ends a line of READ input with a plus sign or hyphen, the READ statement treats it as a continuation symbol and waits for another line of input. For more information, see “Continuation Symbols” on page 10.

### Controlling Uppercase and Lowercase for READ Statement Input

To control uppercase and lowercase for READ statement input, use the CAPS/ASIS/NOCAPS operand on the CONTROL statement, or the &SYSASIS control variable, or the &SYSLC and &SYSCAPS built-in functions. The &SYSASIS control variable and the CAPS/ASIS/NOCAPS operand indicate whether the CLIST should translate *all* READ statement input to uppercase characters. (The CLIST does not modify numbers, national characters, special characters, or DBCS characters in such input.)

If you want the CLIST to translate all input obtained by READ statements to uppercase characters, you can use the default value (CAPS) or code:

```
CONTROL CAPS
```

or

```
SET &SYSASIS = OFF
```

To request that the CLIST leave all input obtained by READ statements in the format in which it was entered, code:

```
CONTROL ASIS
```

or

```
CONTROL NOCAPS
```

or

```
SET &SYSASIS = ON
```

The CAPS/ASIS/NOCAPS operands affect output from WRITE statements the same as they affect input from READ statements.

&SYSLC and &SYSCAPS enable you to tailor individual strings as well as substrings of input strings.

For example, a CLIST that prompts for first, middle, and last names, might want to guarantee that the name is properly capitalized before saving it. The following section of code shows a way to do so:

```
CONTROL ASIS /* Do not translate READ input to uppercase */
WRITENR Enter first name:
READ FNAME
WRITENR Enter middle name:
READ MNAME
WRITENR Enter last name:
READ LNAME
```

```
/* ***** */
/* Set the lengths of the first, middle, and last names to */
/* variables so that the substring notation is easier to read. */
```

## Receiving Responses from Terminal

```
/******
SET LGTHFNAME = &LENGTH(&FNAME)
SET LGTHMNAME = &LENGTH(&MNAME)
SET LGTHLNAME = &LENGTH(&LNAME)

/******
/* Capitalize the first letters in first, middle, and last names */
/* and make sure all other letters are in lowercase characters. */
/******

SET F = &SUBSTR(1,&SYSCAPS(&FNAME))&SUBSTR(2:&LGTHFNAME,&SYSLC(&FNAME))
SET M = &SUBSTR(1,&SYSCAPS(&MNAME))&SUBSTR(2:&LGTHMNAME,&SYSLC(&MNAME))
SET L = &SUBSTR(1,&SYSCAPS(&LNAME))&SUBSTR(2:&LGTHLNAME,&SYSLC(&LNAME))
SET NAME = &STR(&F &M &L)
```

If the input entered is CADman haVvY fisH, &NAME contains the string “Cadman Havvy Fish”.

## Using the READDVAL Statement

The READDVAL statement accesses the contents of the &SYSDVAL control variable. &SYSDVAL contains one of three types of information:

- Information obtained by a READ statement without operands
- The non-delimiter data on the line returning control to the CLIST after a TERMIN statement, as described in “Passing Control to the Terminal” on page 92
- Information that the CLIST explicitly placed into &SYSDVAL with an assignment statement

The CLIST successively places each input string in &SYSDVAL into each variable on the READDVAL statement.

Assume for the remainder of this topic that the following strings are in &SYSDVAL:  
SMITH JONES KELLY

The following statement assigns the strings to symbolic variables:

```
READDVAL NAME1,NAME2,NAME3
```

Note that variables on the READDVAL statement do not require ampersands.

The preceding READDVAL statement produces the following results:

```
&NAME1; has the value SMITH.
&NAME2; has the value JONES.
&NAME3; has the value KELLY.
```

**Note:** The variables &NAME1, &NAME2, and &NAME3 can be set to different values during the execution of a CLIST. However, if the contents of &SYSDVAL is not modified and READDVAL is executed again, those variables are reset to the current value of SYSDVAL.

The following statement also reads all three strings from &SYSDVAL:

```
READDVAL NAME1,NAME2,NAME3,NAME4
```

The value of &NAME4 is null because there are not enough input strings in &SYSDVAL to provide a fourth value.

## Receiving Responses from Terminal

The following statement, however, assigns values only to the variables NAME1 and NAME2:

```
READDVAL NAME1,NAME2
```

Because there are only two variables on READDVAL to which the CLIST can assign the input strings in &SYSDVAL, the CLIST ignores the excess strings. In the previous example, the CLIST ignores KELLY.

---

## Passing Control to the Terminal

Two CLIST statements are available for transferring control to the terminal and establishing a means for the user to return control to the CLIST:

1. TERMIN transfers control to the terminal and establishes a means for the user to return control to the CLIST. A CLIST executed from the TERMIN is considered to be *not* nested within the CLIST that issued the TERMIN statement, and global variables sharing between the two CLISTs is *not* allowed.
2. TERMING transfers control to the terminal and establishes a means for the user to return control to the CLIST. A CLIST executed from the TERMING is considered to be nested within the CLIST that issued the TERMING statement, and global variables sharing between the two CLISTs is allowed.

Other differences in how TERMIN and TERMING transfer control are listed in Table 7.

*Table 7. TERMIN and TERMING Statement Comparison*

| Characteristic                                                                                                                   | TERMIN | TERMING |
|----------------------------------------------------------------------------------------------------------------------------------|--------|---------|
| Share GLOBAL variables across the TERMIN(G) element                                                                              | No     | Yes     |
| Variable access across the TERMIN(G) element through CLIST access routine IKJCT441                                               | No     | Yes     |
| Checking Command Output Trapping - IKJCT441 and IRXEXCOM recognize CLIST and REXX execs on opposing sides of a TERMIN(G) element | No     | Yes     |
| CONTROL NOMSG statement - allow checking the NOMSG setting on opposing sides of a TERMIN(G) element                              | No     | Yes     |

Because the TERMIN and TERMING elements are CLIST-generated type elements which cannot be added to the input stack through the external STACK service routine, they are considered to be of the same type. If the topmost stack element is a TERMIN or TERMING element, return code 60 (X'3C') is returned. For more information see "TERMIN and TERMING Statement" on page 178.

**Note:** If you issue a CLIST containing a TERMIN or TERMING statement, under either ISPF or a REXX exec, or in the TSO/E background, the TERMIN or TERMING statement ends the CLIST. For CLISTs issued in the TSO/E background, TSO/E also issues message IKJ56550I to indicate that the TERMIN or TERMING statement is not supported for background processing.

The TERMIN or TERMING statement either defines character strings, one of which the user must enter to return control to the CLIST; or null lines, where the user must press the Enter key to return control to the CLIST.



## Passing Control to Terminal

The TERMIN or TERMING statement normally does not function alone. WRITE statements preceding the TERMIN or TERMING statement inform the user why control is being transferred to the terminal and how to return control to the CLIST.

Unlike the READ statement, TERMIN or TERMING enables the user to enter commands or subcommands, and invoke programs before responding to the WRITE statement prompts.

As soon as the CLIST issues the TERMIN or TERMING statement, the user receives control at the terminal. The user might receive a mode message after the TERMIN or TERMING statement is issued. If issued, the mode message might be READY or the name of the command under which the CLIST was invoked. (When READY is displayed, users might think the CLIST has terminated. You may want to avoid any confusion by telling them otherwise in the WRITE statement that precedes the TERMIN or TERMING statement.)

## Returning Control After a TERMIN or TERMING Statement

To return control to the CLIST after a TERMIN or TERMING statement, code the TERMIN or TERMING statement and define one or more character strings that return control to the CLIST. For example:

```
TERMIN IGNORE,PROCESS,TERMINATE
```

The user then enters IGNORE, PROCESS, or TERMINATE to return control to the CLIST. The &SYSDLM control variable identifies the position of the string used. For example, if the user enters TERMINATE to return control, &SYSDLM contains a 3 because TERMINATE is the third variable on the TERMIN or TERMING statement. Multiple strings enable the user to indicate desired actions to the CLIST.

You can allow a null line as one of the valid strings but it must be the first string on the TERMIN or TERMING statement. To do so, place a comma directly before the first character string as follows:

```
TERMIN ,PROCESS,TERMINATE
```

The previous statement enables the user to return control by entering either a null line (pressing the Enter key), PROCESS, or TERMINATE.

You can issue a TERMIN or TERMING statement that lets the user return control by entering a null line (pressing the Enter key). To do so, code:

```
TERMIN
```

Exercise care in using a null line as the means for a user to return control to the CLIST, because some TSO/E command processors use null lines as function delimiters (for example, to switch between input and edit modes under EDIT).

## Entering Input After a TERMIN or TERMING Statement

The user can optionally enter input when returning control by appending the input to the string that returns control. The CLIST stores the input in the &SYSDVAL control variable, which the CLIST can then access by executing a READDVAL statement. The READDVAL statement changes the input to upper case, unless you code CONTROL ASIS in the CLIST.

Suppose a WRITE statement prompts the user to inform the CLIST, when returning control after a TERMIN or TERMING statement, if any data sets should be deleted. The user affirms the request by entering the following:

## Passing Control to Terminal

```
PROCESS JCL.CNTL(BUDGT) ACCOUNT.DATA
```

The following CLIST deletes the data sets in the previous statement:

```
WRITE Check your catalog and enter the names of
WRITE up to two data sets you want deleted.
WRITE They must be separated by a comma or blank and
WRITE the first name must be preceded by the word PROCESS
WRITE and a blank. If you do not want to delete any data
WRITE sets, type in the word IGNORE. If you want to end
WRITE the CLIST, type in TERMINATE.
TERMIN IGNORE,PROCESS,TERMINATE
/* Read the two data set names (if any) in &SYSDVAL into
/* variables called &DSN1 and &DSN2
READDVAL DSN1 DSN2
/* If the user wants to delete data sets (PROCESS),
/* delete them
IF &SYSDLM = 2 THEN +
DO
 IF &DSN1=- THEN +
 delete &DSN1
 IF &DSN2=- THEN +
 delete &DSN2
END
/* If the user wants the CLIST to ignore the deletion request
/* but continue processing, execute the rest of CLIST. The
/* null ELSE path covers the request to terminate immediately.
IF &SYSDLM = 1 THEN +
DO
 (Rest of CLIST)
END
```

---

## Using ISPF Panels

A CLIST can communicate with terminal users by displaying panels of the Interactive System Productivity Facility (ISPF). ISPF panels allow users to make selections and enter data; the selections and entries are then available for the CLIST to use. ISPF panels can also invoke CLISTs based on user input. With ISPF, CLISTs can conduct extensive panel-driven dialogs with users.

CLISTs use the ISPEXEC command to display ISPF panels. For complete information about using the ISPEXEC command and its operands, see *z/OS ISPF User's Guide Volume 1*.

## ISPF Restrictions

The names of variables used on ISPF panels can be no longer than eight characters.

## Sample CLIST with ISPF Panels

For an example of displaying ISPF panels from a CLIST, see "Writing Full-Screen Applications Using ISPF Dialogs - The PROFILE CLIST" on page 137. The PROFILE CLIST displays any of four panels, based on input passed at invocation. On two of the panels, user input (pressing the Enter or END PF key) causes the CLIST to display another panel or end the session. The panels for the PROFILE CLIST are illustrated in their ISPF panel-definition form. Instructions for allocating the panels are included.

---

## Chapter 9. Performing File I/O

|                                                     |    |
|-----------------------------------------------------|----|
| Characters Supported in I/O . . . . .               | 95 |
| Opening a File . . . . .                            | 95 |
| Closing a File . . . . .                            | 96 |
| Reading a Record from a File . . . . .              | 96 |
| Writing a Record to a File . . . . .                | 97 |
| Updating a File . . . . .                           | 98 |
| End-of-File Processing . . . . .                    | 98 |
| Special Considerations for Performing I/O . . . . . | 99 |

CLISTs can perform I/O to a physical sequential data set, a member of a partitioned data set (PDS), or the terminal when allocated to a file. Four CLIST statements are available for opening, reading, writing, and closing files:

- OPENFILE opens a previously allocated file for input, output, or updating. You may have allocated the file using the TSO/E ALLOCATE command or using step allocation (JCL statements in a logon procedure).
- GETFILE reads a record from a file opened in the same CLIST.
- PUTFILE writes a record to a file opened in the same CLIST.
- CLOSFILE closes a file opened in the same CLIST.

Whenever a CLIST performs I/O, include an error routine that can handle end-of-file conditions and errors that may occur. “End-of-File Processing” on page 98 shows a CLIST with an error routine that handles end-of-file conditions.

Whenever CLISTs are nested, corresponding OPENFILE, GETFILE, PUTFILE, and CLOSFILE statements must be in the same CLIST.

---

### Characters Supported in I/O

CLIST I/O statements can process all data characters represented by hexadecimal codes 40 through FF. See “Characters Supported in CLISTs” on page 12 for more information and warnings for doing I/O from data sets containing special characters.

---

### Opening a File

The OPENFILE statement has the following syntax:

```
OPENFILE filename {INPUT } /* to read records from the file
 {OUTPUT} /* to write records to the file
 {UPDATE} /* to update records in the file
```

To open a data set for I/O, you must allocate the data set to a file name, then use that file name on the OPENFILE statement. To preserve data integrity, after the file is opened for I/O, CLIST performs only one level of substitution against the file name variable. That is, after the file name is substituted with a file record, and to ensure the file record can be saved in its original format, CLIST does not re-scan the record.

To allocate the data set to a file name, use the ALLOCATE command with the FILE keyword. The file name is an arbitrary value; you can create it on the allocation.

For example, you can code the following:

## Opening a File

```
⋮
allocate file(paycheks) da('d58tan1.checks.data') shr
OPENFILE PAYCHEKS
⋮
```

You can also code the file name as a symbolic variable as follows:

```
⋮
SET FILEID= PAYCHEKS
⋮
allocate file(&FILEID) da('d58tan1.checks.data') shr
OPENFILE &FILEID
⋮
```

You can open a member of a PDS after allocating the member to a file name, for example:

```
allocate file(income) da('d58tan1.receipts(july)') shr
OPENFILE INCOME
```

However, do not use OPENFILE statements to open more than one member of a PDS for output at the same time.

---

## Closing a File

To close an open file, use a CLOSFIL statement that includes the same file name as that specified on the corresponding OPENFILE statement. For example, if you opened a file by coding:

```
OPENFILE &FILEID
```

close that file by coding:

```
CLOSFIL &FILEID
```

If you do not close an open file before the CLIST terminates, you may not be able to process that file again until you logoff and logon again.

For examples of CLOSFIL, see the examples in “Reading a Record from a File” and “Writing a Record to a File” on page 97.

---

## Reading a Record from a File

To read a record from an open file, use a GETFILE statement. The CLIST creates a variable of the same name as the file name and places the record into it. As long as the file remains open, successive GETFILE statements read successive records from the file. When the end of the file has been reached, &LASTCC contains the error code 400. For information about how to detect and handle end-of-file conditions, see “End-of-File Processing” on page 98.

Assume a data set called D58TAN1.CHECKS.DATA contains the following records:

```
200BLACKBUY
449REFY
450YARRUM
```

To read the records into three variables, you could code the following:

```
⋮
(error routine)
⋮
allocate file(paycheks) da('d58tan1.checks.data') shr reu
```

## Reading a Record from a File

```
OPENFILE PAYCHEKS /* Defaults to INPUT */
SET COUNTER=1
DO WHILE &COUNTER -> 3
 GETFILE PAYCHEKS /* Read a record */
 SET EMPLOYEE&COUNTER=&PAYCHEKS /* Store the record */
 SET COUNTER=&COUNTER+1 /* Increase counter by one */
END
CLOSFILE PAYCHEKS /* Close the file */
```

If you use GETFILE to read data from the terminal, the data is translated to uppercase, and the terminal user must end the data with a symbol that the CLIST recognizes as an end-of-file.

---

## Writing a Record to a File

To write a record to a file, do the following:

1. Open the file for output (OPENFILE filename OUTPUT).
2. Set a variable of the same name as the file name to the record you are writing to the file.
3. Specify the file name on the PUTFILE statement to write the record to the data set, for example:

```
OPENFILE PRICES OUTPUT /* open the file for output
SET PRICES = $2590.00 /* set variable to input record
PUTFILE PRICES /* put variable record into the file
```

**Note:** If you use a variable for the filename on a PUTFILE statement, use a nested variable to contain the record, for example:

```
OPENFILE &FILEID OUTPUT /* open the file for output
SET &&FILEID = $2590.00 /* set variable to input record
PUTFILE &FILEID /* put variable record into the file
```

As long as the file remains open, successive PUTFILE statements write successive records to the data set. For a data set with a disposition of NEW, OLD, or SHR, if you close the file and then re-open it, a subsequent PUTFILE statement overlays the first record in the data set. For a data set with a disposition of MOD, if you close the file and then re-open it, a subsequent PUTFILE statement adds a record to the end of the data set.

Assume a CLIST contains the following variables:

```
&EMPLOYEE1,; which contains the value 'BLACKBUY: $200.00'.
&EMPLOYEE2,; which contains the value 'REFY: $449.00'.
&EMPLOYEE3,; which contains the value 'YARRUM: $450.00'.
```

To place the previous values in a data set called D58TAN1.CURNTSAL.DATA, you could code the following:

```
allocate file(salaries) da('d58tan1.curntsalsal.data') shr reu
OPENFILE SALARIES OUTPUT /* Open the file for output */
SET COUNTER=1
DO WHILE &COUNTER -> 3
 SET EMPLOYEE=&&EMPLOYEE&COUNTER
 SET SALARIES=&EMPLOYEE /* Set the record to be written */
 PUTFILE SALARIES /* Write the record */
 SET COUNTER=&COUNTER+1 /* Increase counter by one */
END
CLOSFILE SALARIES /* Close the file */
```

---

### Updating a File

To update a record in an open file, use the GETFILE and PUTFILE statements. After opening a file for updating (OPENFILE filename UPDATE), perform successive GETFILE statements until the desired record is read. After assigning the new value to a variable of the same name as the file name, perform a PUTFILE statement to update the record.

As long as the file remains open, you may update records.

Assume a data set called D58TAN1.CHECKS.DATA has a variable-blocked record format and contains the following records:

```
200BLACKBUY
449REFY
450YARRUM
```

To update the record for REFY, you can code the following:

```
 :
 (error routine)
 :
allocate file(paycheks) da('d58tan1.checks.data') shr reu
OPENFILE PAYCHEKS UPDATE /* Open file for updating */
GETFILE PAYCHEKS /* Read first record */
DO WHILE &SUBSTR(4:7,&PAYCHEKS)~=REFY
 GETFILE PAYCHEKS /* Read another record */
END
SET PAYCHEKS = 000REFY /* Set new value */
PUTFILE PAYCHEKS /* Write new value to data set */
CLOSEFILE PAYCHEKS /* Close the file */
```

---

### End-of-File Processing

Whenever a CLIST performs I/O, include code that handles end-of-file conditions. In a CLIST, end-of-file causes an error condition (error code 400). To process this condition, provide an error routine before the code that performs the I/O.

An error routine is a block of code that gets control when an error occurs in a CLIST. The error routine can try to identify the error (such as error code 400) and take appropriate action. For a complete description of how to write an error routine, see Chapter 10, "Writing ATTN and ERROR Routines" on page 101.

The following error routine saves the value of &LASTCC, closes and frees the open file, and branches to a statement that determines whether end-of-file was reached.

```
SET RCODE=0 /* Initialize the return code variable to 0 */
SET EOF=OFF /* Set the end-of-file indicator off */
 :
ERROR +
DO
 SET RCODE = &LASTCC /* Save the value of &LASTCC */
 IF &RCODE=400 THEN +
 DO
 CLOSEFILE PAYCHEKS /* Close the open file
 free f(paycheks) /* Free the open file
 WRITE No record to update because end-of-file was reached.
 SET EOF=ON
 RETURN /* Branch to statement that tests for
 END /* EOF (IF &EOF=ON THEN...)
 ELSE EXIT /* For other errors, EXIT
 END
allocate file(paycheks) da('d58tan.checks.data') shr reu /* Allocate
```

```

/* file */
/* and establish file name of paycheks */
OPENFILE PAYCHEKS UPDATE /* Open file for updating */
SET COUNTER=1 /* Initialize counter to 1 */
DO WHILE &COUNTER <= 4
 GETFILE PAYCHEKS /* Skip records */
 SET COUNTER= &COUNTER+1 /* Increase counter by 1 */
/* If EOF reached, end loop. Null else */
IF &EOF=ON THEN GOTO OUT
END
SET PAYCHEKS = 480BUZZBEE /* Set variable to new value */
PUTFILE PAYCHEKS /* Update fourth record */
CLOSEFILE PAYCHEKS /* Close the file */
:
:
(rest of CLIST)
:
:
OUT: END

```

---

## Special Considerations for Performing I/O

- **MOD operand**  
When allocating the data set you can use the MOD operand. It allows you to append data to the end of a sequential data set. For more information on the MOD operand see *z/OS TSO/E Command Reference*, and *z/OS TSO/E REXX User's Guide*.
- **Records Containing JCL Statements**  
If a CLIST reads or writes records containing JCL statements, that CLIST could make unwanted modifications to the statements by symbolic substitution. To prevent the unwanted modifications, use the &NRSTR or &SYSNSUB built-in functions. See Chapter 6, "Using Built-in Functions" on page 51 for details and examples.
- **Concatenated Data Sets**  
You can perform I/O on multiple data sets that are allocated (concatenated) to a single file name. However, the first data set in the concatenation must not be empty: if a GETFILE statement is issued and the first data set in the concatenation is empty, all other data sets allocated to the file are ignored, and no records are read.

## Special Considerations for Performing I/O



---

## Chapter 10. Writing ATTN and ERROR Routines

|                                                                |     |
|----------------------------------------------------------------|-----|
| Writing Attention Routines . . . . .                           | 101 |
| Cancelling Attention Routines . . . . .                        | 102 |
| Protecting the Input Stack from Attention Interrupts . . . . . | 102 |
| Sample CLIST with an Attention Routine . . . . .               | 102 |
| Subprocedures and Attention Routines. . . . .                  | 104 |
| CLIST Attention Facility . . . . .                             | 104 |
| Writing Error Routines. . . . .                                | 105 |
| Cancelling Error Routines . . . . .                            | 105 |
| Protecting the Input Stack from Errors . . . . .               | 106 |
| Sample CLIST with an Error Routine . . . . .                   | 106 |
| Subprocedures and Error Routines . . . . .                     | 106 |

Two types of events cause the execution of a CLIST to halt prematurely: attention interrupts and errors. The CLIST language provides two statements that enable you to code routines to handle attention interrupts and errors. They are ATTN and ERROR, respectively. The ATTN statement is described in “Writing Attention Routines”. The ERROR statement is described in “Writing Error Routines” on page 105.

An attention interrupt occurs when the user presses the attention key (usually PA1 or ATTN) on the terminal keyboard. The user may enter an attention interrupt for any number of reasons, such as to terminate an infinite loop or simply to end the CLIST. The user cannot enter an attention interrupt when a CLIST error routine is in execution as a result of a CLIST-invoked command processor abend or before a TSO/E command is executed within the CLIST. Any attention interruption received while a command abend is in progress is ignored.

An error can occur for any number of reasons, such as a numeric value that exceeds  $2^{31}-1$ , an end-of-file condition, or a non-zero return code from a TSO/E command.

---

### Writing Attention Routines

Use the ATTN statement to identify an action to be taken when the user enters an attention interrupt. The action can be any executable statement and is often a DO-sequence that performs operations tailored to the CLIST. You can structure an ATTN action as follows:

```
ATTN +
 DO
 :
 (action)
 :
 END
```

The ATTN statement and its action must precede the code to which it applies. Multiple CLIST statements may be executed in the action but only one TSO/E command, TSO/E subcommand, or null line may be executed. (A null line returns control to the statement or command that was executing when the attention interrupt occurred.) If the one TSO/E command executed is an invocation of an attention handling CLIST, you may execute as many TSO/E commands or subcommands as you wish in the attention handling CLIST.

## Writing Attention Routines

If an attention action does not execute a TSO/E command, subcommand, or null line, the action must include an EXIT or RETURN statement. The EXIT statement ends the CLIST, and the RETURN statement returns control to the CLIST statement, command, or subcommand following the one that was executing when the user entered the attention interrupt.

You should inform the user at the beginning of the attention routine that TSO/E is processing the attention interrupt. Otherwise, the user may enter another attention interrupt. For a description of how TSO/E processes multiple attention interrupts, see *z/OS TSO/E Programming Services*.

## Cancelling Attention Routines

You can cancel an attention routine at any point, letting the CLIST continue without any special attention processing. To cancel an attention routine, code:

```
ATTN OFF
```

This entry nullifies the most recently established attention routine. ATTN OFF should not be used within an attention routine itself.

You can also code attention routines that override previous ones. Each attention routine overrides all previous ones. You can initialize new attention routines as many times as you wish.

## Protecting the Input Stack from Attention Interrupts

When a CLIST is executed, it translates each statement into an executable format and places it in a section of storage called the input stack. The input stack is the source from which TSO/E obtains its input (TSO/E commands, CLIST statements).

If you write an attention routine that does not terminate the CLIST, protect the input stack from being erased (flushed) from storage when an attention interrupt occurs. You can protect the input stack by coding a CONTROL statement with the MAIN operand. The MAIN operand indicates that the CLIST is the main CLIST in the invoker's TSO/E environment and prevents TSO/E from flushing the input stack in the event of an attention interrupt.

Attention routine processing depends on whether CONTROL MAIN has been coded, and whether the routine executes a TSO/E command, RETURN statement, or null line.

- If CONTROL MAIN has not been coded, the CLIST terminates and the user sees the READY message, indicating that control has returned to the terminal.
- If CONTROL MAIN has been coded, and a null line executes in the attention routine, the CLIST continues at the statement or command that was executing when the user entered the attention interrupt.
- If CONTROL MAIN has been coded, and a TSO/E command or RETURN statement is issued, the CLIST continues at the statement or command *following* the one that was executing when the user entered the attention interrupt.

Also refer to *z/OS TSO/E User's Guide*, for a further explanation of attention interrupt processing.

## Sample CLIST with an Attention Routine

The ALLOCATE CLIST shown in Figure 4 on page 103 contains an attention routine that prompts the user to indicate whether he or she wants to end the CLIST.

## Writing Attention Routines

If the user types YES to end the CLIST, and data sets have been allocated, the attention routine invokes a CLIST called HOUSKPNG (see Figure 5 on page 104), which frees the allocated data sets. Then the attention routine ends the ALLOCATE CLIST.

If the user *does not* type YES to end the ALLOCATE CLIST, the attention routine issues CONTROL MAIN and a null line to return control to the point where the attention interrupt occurred.

Note that the attention routine in Figure 4 issues only one TSO/E command: %houskpng or the null line. However, the HOUSKPNG CLIST itself issues up to three commands, depending on how many data sets it has to free.

---

```
/******
/* THE ALLOCATE CLIST ALLOCATES THREE DATA SETS REQUIRED FOR */
/* A PROGRAM. IT IS EQUIPPED TO HANDLE ATTENTION INTERRUPTS */
/* ENTERED AT ANY POINT. WHEN NECESSARY, IT INVOKES HOUSKPNG. */
/******

PROC 2 &DS1 &DS2
CONTROL END(STOP) /* substitute "STOP" for END statement */
CONTROL PROMPT
ATTN +
 DO
 WRITE TSO is processing your attention
 WRITENR Do you want to end? If so, type YES ====>
 READ &END
 IF &END = YES THEN +
/* If user wants to end, terminate the CLIST after the HOUSKPNG routine */ +
/* frees any data sets allocated by the CLIST. */
 DO
 CONTROL FLUSH /* flush the input stack after HOUSKPNG */
 STOP
 ELSE +
 CONTROL MAIN /* return control to the CLIST */
 IF &FOOTPRINT = YES AND &END = YES THEN +
 %houskpng &ds1 &ds2 &cleanup /* call HOUSKPNG to free data sets */
 ELSE +
 DO
 SET &NULL =
 &NULL /* issue null line to continue at the */
 /* point where the attention occurred. */
 STOP
 STOP
 alloc f(input) da(&ds1.text) shr reu
 SET FOOTPRINT = YES
 SET CLEANUP=1
 alloc f(output) da(&ds2.text) reu
 SET CLEANUP=2
 alloc f(temp) da(temp.text)
 SET CLEANUP=3
 call 'myid.myprog.load(member)'
 free f(temp) da(temp.text)
 SET CLEANUP=2
 free f(output) da(&ds2.text)
 SET CLEANUP=1
 free f(input) da(&ds1.text)
 SET FOOTPRINT = /* Set FOOTPRINT back to null */
```

---

Figure 4. A CLIST Containing an Attention Routine - The ALLOCATE CLIST

## Writing Attention Routines

---

```
/******
/* THE HOUSKPNG CLIST IS INVOKED WHEN THE USER WANTS TO END THE */
/* ALLOCATE CLIST AFTER AN ATTENTION AND DATA SETS ARE ALREADY */
/* ALLOCATED. BASED ON THE VALUE OF THE VARIABLE CLEANUP, */
/* THE CLIST FREES FROM ONE TO THREE OF THE DATA SETS ALLOCATED */
/* IN THE ALLOCATE CLIST. */
/******

PROC 3 &DS1 &DS2 &CLEANUP
CONTROL END(ENDO)
ATTN +
 EXIT QUIT
IF &CLEANUP=1 THEN +
 free f(input) da(&ds1.text)
IF &CLEANUP=2 THEN +
 DO
 free f(input) da(&ds1.text)
 free f(output) da(&ds2.text)
 ENDO
IF &CLEANUP=3 THEN +
 DO
 free f(input) da(&ds1.text)
 free f(output) da(&ds2.text)
 free f(temp) da(temp.text)
 ENDO
```

---

Figure 5. An Attention Handling CLIST - The HOUSKPNG CLIST

## Subprocedures and Attention Routines

Attention routines can call CLIST subprocedures. TSO/E commands in called subprocedures have the same effect as TSO/E commands in the attention routine itself: when the first TSO/E command executes, attention processing ends and control passes to the line in the CLIST following the one that was executing when the attention interrupt occurred.

Subprocedures can contain attention routines. However, attention routines in subprocedures cannot contain nested attention or error routines.

## CLIST Attention Facility

The CLIST attention facility (in TSO/E) and the CLSTATTN parameter of the STAX macro provide greater flexibility in the handling of attention interruptions. The CLSTATTN parameter of the STAX macro lets a program establish an attention routine that receives control when an attention interruption occurs during the processing of a CLIST that contains an attention routine. The program's attention routine can invoke the CLIST attention facility to process the CLIST attention routine.

Previously, the terminal monitor program (TMP) handled attention interruptions for CLISTs with attention routines. Now a program can maintain control by having its own attention routine perform that processing. For more information about using the CLIST attention facility and the STAX macro, see *z/OS TSO/E Programming Services*.

## Writing Error Routines

Use the ERROR statement to create an error routine. The error routine defines an action to be taken when a CLIST receives a non-zero return code from something other than a CLIST subprocedure. (Table 8 on page 111 lists the CLIST error codes.) The action can be any executable statement and is often a DO-group that performs operations tailored to the indicated error. You can structure an ERROR action as follows:

```
ERROR +
DO
 :
 (action)
 :
END
```

The ERROR statement and its action must precede the code to which it applies. An action may contain TSO/E commands and subcommands, subject to the mode in which the CLIST is executing when the error occurs. Unlike attention routines, error routine actions can issue multiple TSO/E commands or subcommands.

If an error routine action does not end the CLIST, it must include a RETURN statement. The RETURN statement returns control to the CLIST statement, TSO/E command, or TSO/E subcommand following the one that was executing when the error occurred. Repeated errors which activate the same error routine may cause the CLIST to terminate.

You may also code error routines that override previous ones. Each error routine overrides all previous ones. You may initialize new error routines as many times as you want.

## Cancelling Error Routines

To cancel the most recently established error routine in a CLIST, code either:

```
ERROR OFF
```

or

```
ERROR
```

following the error routine to be cancelled.

When ERROR OFF is coded, processing continues as if an error routine had never been established. When a failure occurs, one of the following occurs depending on the type of failure:

- If the failure was due to an ABEND or non-zero return code from a TSO/E command or subcommand, the CLIST continues execution with the next sequential instruction following the failing instruction.
- If the failure was in a CLIST statement or in expression evaluation, the failing instruction and explanatory CLIST error messages are displayed, and the CLIST terminates.

When ERROR is entered with no operands, the CLIST displays the command, subcommand, or statement on the CLIST that ended in error. No explanatory CLIST error messages are displayed. &LASTCC is reset to 0 and the CLIST continues with the next sequential statement or command.

## Writing Error Routines

### Protecting the Input Stack from Errors

When a CLIST is executed, it translates each statement into an executable format and places it in a section of storage called the input stack. The input stack is the source from which TSO/E obtains its input (TSO/E commands, CLIST statements).

If you write a CLIST that contains an error routine, protect the input stack from being erased from storage (flushed) when an error occurs. You can protect the input stack by coding a CONTROL statement that includes the NOFLUSH or MAIN operand. The CONTROL statement must appear before any error routine, preferably at the beginning of the CLIST.

### Sample CLIST with an Error Routine

The COPYDATA CLIST, shown in Figure 6 on page 107, contains an error routine that handles:

- Pre-allocation errors
- End-of-file condition
- Allocation errors

The CLIST allocates the data sets required to copy an existing data set into an output data set. If the copy is successful, the CLIST cancels the error routine by executing an ERROR statement with no operands and continues.

### Subprocedures and Error Routines

Error routines can call CLIST subprocedures, and subprocedures can issue the RETURN statement to return control to the error routine. The error routine itself must issue RETURN to return control to the statement after the one in error. For example, the following error routine calls a subprocedure:

```
ERROR +
DO
 SET &ECODE = 8
 SELECT
 WHEN (&FOOTPRINT=2) SYSCALL ABC ECODE
 :
 END /* End of SELECT
 RETURN /* return control to CLIST
 END /* End of error routine
 :
ABC: PROC 1 CODEPARM /* subroutine ABC
SYSREF &CODEPARM /* refer variable back to caller's &ECODE
free f(indata) /* free data sets
free f(outdata)
SET &CODEPARM = 12 /* set error code
RETURN /* return control to error routine
END /* end of subroutine ABC
```

Subprocedures can contain error routines. However, error routines in subprocedures cannot contain nested attention or error routines.

```

/*****/
/* THE COPYDATA CLIST COPIES RECORDS FROM A DATA SET INTO AN */
/* OUTPUT DATA SET. IT IS EQUIPPED TO HANDLE ERRORS CAUSED BY */
/* END-OF-FILE, ALLOCATION ERRORS, AND ERRORS CAUSED BY OTHER */
/* STATEMENTS AND COMMANDS IN THE CLIST. */
/*****/

CONTROL NOFLUSH END(ENDO) /* Protect the stack from being flushed
/* so that when error is caused by end-of-file, CLIST can continue
ERROR +
DO
 SET RCODE=&LASTCC /* Save return code
 /* If end-of-file, branch to CLOSFIE statements
 SELECT
 WHEN (&RCODE=400) +
 DO /* IF End-of-file is reached, */
 SET EOFLAG = YES /* Set flag and return to the */
 RETURN /* I/O procedure. */
 ENDO
 /* If error occurred before allocation, set exit code to 4
 WHEN (&FOOTPRINT=0) SET ECODE=4
 /* If allocation of file OUTDS failed, free file INDATA and set
 /* exit code to 8
 WHEN (&FOOTPRINT=1) +
 DO
 free f(indata) da(text.data)
 SET ECODE=8
 ENDO
 /* If the error was not caused by end-of-file or allocation error,
 /* free both files and set exit code to 12. In this case, error was
 /* caused by one of the file I/O statements
 WHEN (&FOOTPRINT=2) +
 DO
 free f(indata) da(text.data)
 free f(outds)
 SET ECODE=12
 ENDO
 ENDO /* End of SELECT statement
 EXIT CODE(&ECODE) /* For all errors except end-of-file condition,
 /* exit the CLIST with the appropriate exit code
 ENDO /* End of error routine
SET FOOTPRINT=0 /* Identify pre-allocation errors
:
SET FOOTPRINT=1 /* Identify allocation error for file INDATA
alloc f(indata) da(d15rbo1.text.data) shr reu /* Allocate input data set
SET FOOTPRINT=2 /* Identify allocation error for file OUTDS
alloc f(outds) sysout(a) /* Allocate output data set
OPENFILE INDATA /* Open input data set
OPENFILE OUTDS OUTPUT /* Open output data set
/* Copy records from input data set to output data set */

```

Figure 6. The COPYDATA CLIST (Part 1 of 2)

## Writing Error Routines

---

```
DO WHILE &EOFFLAG ^= YES /* Do the following until EOF is reached*/
 GETFILE INDATA /* Read input record
 IF &EOFFLAG ^= YES THEN +
 DO
 SET OUTDS=&INDATA /* Set output record to value of input record
 PUTFILE OUTDS /* Write output record to output data set
 ENDO
 ENDO
EOF: CLOSFIL INDATA /* Close input data set
CLOSFIL OUTDS /* Close output data set
ERROR /* From this point on, display statement that causes error
/* along with any error messages
 :
```

---

*Figure 6. The COPYDATA CLIST (Part 2 of 2)*



---

## Chapter 11. Testing and Debugging CLISTs

|                                                             |     |
|-------------------------------------------------------------|-----|
| Using Diagnostic Options of the CONTROL Statement . . . . . | 109 |
| Messages in Diagnostic Output . . . . .                     | 110 |
| How to Make Diagnostic Output Optional in a CLIST . . . . . | 111 |
| Getting Help for CLIST Messages . . . . .                   | 111 |
| Obtaining CLIST Error Codes . . . . .                       | 111 |

This chapter describes how to test CLISTs using diagnostic procedures to find and correct errors. The diagnostic procedures include:

- Using diagnostic options of the CONTROL statement to find errors in CLIST statements and TSO/E commands
- Getting help for CLIST messages
- Finding and understanding CLIST error codes

---

### Using Diagnostic Options of the CONTROL Statement

The CONTROL statement lets you define processing options for a CLIST. Some of the CONTROL statement options can help you diagnose CLIST errors. These diagnostic options, LIST, CONLIST, SYMLIST, and MSG, cause a CLIST to display its statements, commands, and any informational messages at the terminal when you execute the CLIST. From the displayed information, you can often find statements or commands that contain errors.

You can use the diagnostic options separately or together on the CONTROL statement. To obtain the most complete diagnostic information, code the options together (the order is not significant):

```
CONTROL LIST CONLIST SYMLIST MSG
```

You can place the CONTROL statement at the top of the CLIST or in any part of the CLIST that you want to test or debug. Each CONTROL statement overrides any previous CONTROL statements. To turn off the diagnostic options, type:

```
CONTROL NOLIST NOCONLIST NOSYMLIST NOMSG
```

As an alternative to retyping the CONTROL statement when you want to change options, you can use the control variables &SYSLIST, &SYSCONLIST, &SYSSYMLIST, and &SYSMSG to test or change the current settings. For more information about using these control variables, see “Setting Options of the CLIST CONTROL Statement” on page 42.

The diagnostic options have the following effects:

#### **SYMLIST**

The CLIST displays each TSO/E command, subcommand, or CLIST statement at the terminal before scanning it for symbolic substitution.

#### **LIST**

The CLIST displays each TSO/E command or subcommand at the terminal after symbolic substitution but before execution.

#### **CONLIST**

The CLIST displays each CLIST statement at the terminal after symbolic substitution but before execution.

## Diagnostic Options of CONTROL Statement

### MSG

The CLIST displays informational messages at the terminal.

**Note:** SYMLIST and CONLIST do not display the GLOBAL or NGLOBAL statements.

The CLIST in Figure 7 contains diagnostic options on the CONTROL statement. When you execute the CLIST, the commands and statements appear at the terminal as shown in Figure 8.

```
CONTROL LIST CONLIST SYMLIST MSG
SET INPUT = data.set.name
SET DSN = &INPUT;
allocate file(a) dataset('myid.&dsn')
free file(a)
```

Figure 7. Sample CLIST with Diagnostic CONTROL Options

```
SET INPUT = data.set.name
SET INPUT = data.set.name
SET DSN = &INPUT;
SET DSN = data.set.name
allocate file(a) dataset('myid.&dsn')
allocate file(a) dataset('myid.data.set.name')
free file(a)
free file(a)
```

Figure 8. Diagnostic Output from Sample CLIST

Notice that each statement and command appears twice at the terminal. The first version is caused by CONTROL SYMLIST and shows the statement or command as it appears in the CLIST. The second version shows the results of symbolic substitution on the preceding line. If a line undergoes no substitution (contains no variables), both versions are the same.

## Messages in Diagnostic Output

The CLIST executes each statement or command after performing symbolic substitution on it. Therefore, when you use the MSG option with LIST and CONLIST, messages about execution errors appear at the terminal after the line that caused the error.

For example, the CLIST in Figure 7 fails when the input data set is not cataloged. When the input data set is not cataloged, the CLIST displays the following information at the terminal, with messages after the statement that failed to execute.

```
SET INPUT = data.set.name
SET INPUT = data.set.name
SET DSN = &INPUT;
SET DSN = data.set.name
allocate file(a) dataset('myid.&dsn')
allocate file(a) dataset('myid.data.set.name')
IKJ56228I DATA SET MYID.DATA.SET.NAME NOT FOUND IN CATALOG
OR CATALOG CANNOT BE ACCESSED
IKJ56701I MISSING DATA SET NAME+
IKJ56701I MISSING NAME OF DATA SET TO BE ALLOCATED
```

Figure 9. Error Messages in Diagnostic Output from Sample CLIST

## Diagnostic Options of CONTROL Statement

The diagnostic output ends after the ALLOCATE command, when the CLIST detects the error. Working backwards from the last line, you can find and correct the source of the error (in this case, the value of &INPUT).

Note that the last line in Figure 9 on page 110 is a continuation of the preceding message line. When the CLIST is executed under ISPF, the continuation is displayed as shown in Figure 9 on page 110. Under line-mode TSO/E, you must type a question mark (?) after the plus sign to see the continuation.

## How to Make Diagnostic Output Optional in a CLIST

You can make the diagnostic output available as an option to anyone who invokes your CLIST. To do so, code a keyword parameter such as DEBUG on the PROC statement as follows:

```
PROC 0 DEBUG
IF &DEBUG=DEBUG THEN +
CONTROL LIST CONLIST SYMLIST MSG
```

The CONTROL options take effect when you invoke the CLIST with the DEBUG parameter, for example (explicit invocation):

```
EX clistname 'DEBUG'
```

or, implicit invocation:

```
%clistname DEBUG
```

---

## Getting Help for CLIST Messages

CLIST message numbers begin with the characters IKJ. For explanations of CLIST messages, look up the message number in the IKJ section of *z/OS TSO/E Messages*. The message explanations include information about the action, if any, you need to take to correct a problem.

---

## Obtaining CLIST Error Codes

The CLIST control variable &LASTCC contains an error code from the last TSO/E command or CLIST statement executed. After each command or statement in a CLIST, you can retrieve the error code from &LASTCC, for example, by coding

```
SET ECODE = &LASTCC
```

You can then write the error code to the terminal or use it as a basis for further processing. For more information about using &LASTCC, see “Getting Return Codes and Reason Codes” on page 47.

**Note:** With the exception of the RETURN statement, CLIST statements and TSO/E commands in error routines do not update the value of &LASTCC. If you use &LASTCC in an error routine, &LASTCC contains the return code from the command or statement that was executing when the error occurred.

Table 8 lists and explains the error codes that CLIST statements return in &LASTCC. Except as otherwise noted, the codes are in decimal format.

Table 8. CLIST Statement Error Codes (Decimal)

| Error Code | Meaning                                               |
|------------|-------------------------------------------------------|
| 16         | Not enough virtual storage. Log on with more storage. |

## Obtaining CLIST Error Codes

Table 8. CLIST Statement Error Codes (Decimal) (continued)

| Error Code | Meaning                                                                                                                                 |
|------------|-----------------------------------------------------------------------------------------------------------------------------------------|
| 300        | User tried to update a control variable that can only be updated by the system.                                                         |
| 304        | Not valid keyword found on EXIT statement.                                                                                              |
| 308        | CODE keyword specified, but no code given on EXIT statement.                                                                            |
| 312        | Internal GLOBAL processing error.                                                                                                       |
| 316        | TERMIN delimiter has more than 256 characters.                                                                                          |
| 324        | GETLINE error.                                                                                                                          |
| 328        | More than 64 delimiters on TERMIN.                                                                                                      |
| 332        | Not valid file name syntax.                                                                                                             |
| 336        | File already open.                                                                                                                      |
| 340        | Not valid OPEN type syntax.                                                                                                             |
| 344        | Undefined OPEN type.                                                                                                                    |
| 348        | File specified did not open. (For example, the file name was not allocated.) Reallocate the file.                                       |
| 352        | GETFILE - file name is not currently open.                                                                                              |
| 356        | GETFILE - the file has been closed by the system. (For example, the file was opened under EDIT mode and EDIT mode has been terminated.) |
| 360        | PUTFILE - file name not currently open.                                                                                                 |
| 364        | PUTFILE - file closed by system (see code 356).                                                                                         |
| 368        | PUTFILE - CLOSFILE - file not opened by OPENFILE.                                                                                       |
| 372        | PUTFILE - issued before GETFILE on a file opened for update.                                                                            |
| 376        | Unable to open the directory of a PDS using a variable record format.                                                                   |
| 380        | Data sets with a logical record length greater than 32767 are not supported for CLIST I/O.                                              |
| 400        | GETFILE - end of file. TSO/E treats this condition as an error that can be handled by an ERROR action.                                  |
| 404        | User tried to write to a file open for INPUT.                                                                                           |
| 408        | User tried to read from a file open for OUTPUT.                                                                                         |
| 412        | User tried to update a file after end of file was reached.                                                                              |
| 416        | User tried to update an empty file.                                                                                                     |
| 500        | The TO value on a DO statement is non-numeric.                                                                                          |
| 502        | The FROM value on a DO statement is non-numeric.                                                                                        |
| 504        | The BY value on a DO statement is non-numeric.                                                                                          |
| 508        | A SYSCALL statement contains an undefined procedure name.                                                                               |
| 512        | A RETURN statement contains an undefined keyword.                                                                                       |
| 516        | The name of a procedure is used as a variable.                                                                                          |
| 524        | Unable to establish an ESTAE routine.                                                                                                   |
| 528        | A positional specification on the PROC statement was not valid.                                                                         |
| 532        | Not valid characters were found in a symbolic parameter on the PROC statement.                                                          |

## Obtaining CLIST Error Codes

Table 8. CLIST Statement Error Codes (Decimal) (continued)

| Error Code | Meaning                                                                                                               |
|------------|-----------------------------------------------------------------------------------------------------------------------|
| 536        | A symbolic parameter name on the PROC statement is too long.                                                          |
| 540        | The number of positional parameters defined on the PROC statement is fewer than the number passed.                    |
| 544        | No symbolic parameters were defined on the PROC statement.                                                            |
| 548        | Duplicate parameter names were found on the PROC statement.                                                           |
| 552        | A keyword parameter has a not valid default value.                                                                    |
| 556        | A default keyword value was missing an ending quote on the PROC statement.                                            |
| 560        | A PARSE error occurred while processing the PROC statement.                                                           |
| 568        | Abnormal termination                                                                                                  |
| 572        | SYSREF variable was not passed as a parameter.                                                                        |
| 576        | SYSREF variable was not defined on a PROC statement.                                                                  |
| 580        | An ERROR statement was found within a subprocedure's ERROR or ATTN routine.                                           |
| 584        | An ATTN statement was found within a subprocedure's ERROR or ATTN routine.                                            |
| 588        | A character between DBCS delimiters was outside the range of double-byte characters.                                  |
| 592        | A DBCS string contains an odd number of bytes, indicating that one of the characters is incomplete.                   |
| 596        | A beginning DBCS delimiter was found without a corresponding ending delimiter.                                        |
| 600        | Two beginning DBCS delimiters were found without an intervening ending delimiter.                                     |
| 604        | An error occurred while processing an installation-written CLIST built-in function in IKJCT44B.                       |
| 608        | An error occurred while processing an installation-written CLIST statement in IKJCT44S.                               |
| 612        | An error occurred in an installation exit.                                                                            |
| 620        | EBCDIC &SYSTWOBYTE data is outside valid DBCS range.                                                                  |
| 624        | An error occurred while processing a system variable (see note below).                                                |
| 708        | The preceding statement has a not valid &SYSINDEX expression.                                                         |
| 712        | The preceding statement has a not valid &SYSINDEX start parameter; the start parameter must be a non-negative number. |
| 716        | The preceding statement has a not valid &SYSNSUB level parameter; the level parameter must be a number from 0 to 99.  |
| 720        | The preceding statement has a missing &SYSNSUB level and/or expression parameter.                                     |
| 724        | The preceding statement has a &SYSNSUB level parameter that uses a built-in function as a symbolic variable.          |
| 8xx        | Evaluation routine error codes.                                                                                       |
| 800        | Data was found where operator was expected.                                                                           |
| 804        | An operator was found where data was expected.                                                                        |

## Obtaining CLIST Error Codes

Table 8. CLIST Statement Error Codes (Decimal) (continued)

| Error Code | Meaning                                                                                                                                                                            |
|------------|------------------------------------------------------------------------------------------------------------------------------------------------------------------------------------|
| 808        | A comparison operator was used in a SET statement.                                                                                                                                 |
| 812        | (Reserved).                                                                                                                                                                        |
| 816        | An operator was found at the end of a statement.                                                                                                                                   |
| 820        | Operators are out of order; data may resemble operators.                                                                                                                           |
| 824        | More than one exclusive operator was found.                                                                                                                                        |
| 828        | More than one exclusive comparison operator found.                                                                                                                                 |
| 832        | The result of an arithmetic calculation is outside the valid range, -2,147,483,647 to +2,147,483,647.                                                                              |
| 836        | (Reserved).                                                                                                                                                                        |
| 840        | Not enough operands.                                                                                                                                                               |
| 844        | No valid operators.                                                                                                                                                                |
| 848        | An attempt was made to load data as character data, but the data was numeric (an arithmetic operation had been performed on the data).                                             |
| 852        | Addition error - character data.                                                                                                                                                   |
| 856        | Subtraction error - character data.                                                                                                                                                |
| 860        | Multiplication error - character data.                                                                                                                                             |
| 864        | Divide error - character data or division by 0.                                                                                                                                    |
| 868        | Prefix found on character data.                                                                                                                                                    |
| 872        | Numeric value is too large.                                                                                                                                                        |
| 900        | Single ampersand was found.                                                                                                                                                        |
| 904        | (Reserved).                                                                                                                                                                        |
| 908        | An error occurred in an error action that received control because of another error.                                                                                               |
| 912        | Substring range is not valid.                                                                                                                                                      |
| 916        | A non-numeric value was found in a substring range.                                                                                                                                |
| 920        | Substring range value too small (zero or negative).                                                                                                                                |
| 924        | Substring syntax is not valid.                                                                                                                                                     |
| 932        | Substring found outside of the range of the string. (For example, an &SUBSTR variable attempted to substring the first three positions of data that contains only two characters.) |
| 936        | A built-in variable that requires a value was entered without a value.                                                                                                             |
| 940        | Not valid symbolic variable.                                                                                                                                                       |
| 944        | A label was used as a symbolic variable.                                                                                                                                           |
| 948        | Not valid label syntax on a GOTO statement.                                                                                                                                        |
| 952        | A GOTO label was not defined.                                                                                                                                                      |
| 956        | A GOTO statement has no label.                                                                                                                                                     |
| 960        | &SYSSCAN was set to a not valid value.                                                                                                                                             |
| 964        | &LASTCC was set to a not valid value and EXIT tried to use it as a default value.                                                                                                  |
| 968        | DATA PROMPT-ENDDATA statements supplied, but no prompt occurred.                                                                                                                   |

## Obtaining CLIST Error Codes

Table 8. CLIST Statement Error Codes (Decimal) (continued)

| Error Code                                                                                                                                                                                        | Meaning                                                                 |
|---------------------------------------------------------------------------------------------------------------------------------------------------------------------------------------------------|-------------------------------------------------------------------------|
| 972                                                                                                                                                                                               | TERMIN statement cannot be used in background jobs.                     |
| 976                                                                                                                                                                                               | READ statement cannot be used in background jobs.                       |
| 980                                                                                                                                                                                               | Maximum statement length (32756) exceeded during symbolic substitution. |
| 984                                                                                                                                                                                               | TERMING delimiter has more than 256 characters.                         |
| 988                                                                                                                                                                                               | TERMING has more than 64 delimiters.                                    |
| 992                                                                                                                                                                                               | TERMING statement cannot be used in background jobs.                    |
| 999                                                                                                                                                                                               | Internal CLIST error.                                                   |
| Sxxx                                                                                                                                                                                              | A system abend code, printed in hexadecimal.                            |
| Uxxx                                                                                                                                                                                              | A user abend code, printed in hexadecimal.                              |
| <b>Note:</b> The underlying error, which is summarized by error code 624, will always be shown by a more detailed error message; this message will not be suppressed when using an error routine. |                                                                         |

## Obtaining CLIST Error Codes



## Chapter 12. Sample CLISTs

|                                                                                            |     |
|--------------------------------------------------------------------------------------------|-----|
| Including TSO/E Commands - The LISTER CLIST . . . . .                                      | 118 |
| Simplifying Routine Tasks - The DELETEDS CLIST . . . . .                                   | 118 |
| Creating Arithmetic Expressions from User-Supplied Input - The CALC CLIST . . . . .        | 119 |
| Using Front-End Prompting - The CALCFTND CLIST . . . . .                                   | 119 |
| Initializing and Invoking System Services - The SCRIPTDS CLIST . . . . .                   | 121 |
| Invoking CLISTs to Perform Subtasks - The SCRIPTN CLIST . . . . .                          | 122 |
| Including JCL Statements - The SUBMITDS CLIST . . . . .                                    | 125 |
| Analyzing Input Strings with &SUBSTR - The SUBMITFQ CLIST . . . . .                        | 125 |
| Allowing Foreground and Background Execution of Programs - The<br>RUNPRICE CLIST . . . . . | 126 |
| Including Options - The TESTDYN CLIST . . . . .                                            | 127 |
| Simplifying System-Related Tasks - The COMPRESS CLIST . . . . .                            | 129 |
| Simplifying Interfaces to Applications - The CASH CLIST . . . . .                          | 131 |
| Using &SYSDVAL When Performing I/O - The PHONE CLIST . . . . .                             | 132 |
| Allocating Data Sets to SYSPROC - The SPROC CLIST . . . . .                                | 133 |
| Writing Full-Screen Applications Using ISPF Dialogs - The PROFILE CLIST . . . . .          | 137 |
| Allocating a Data Set with LISTDSI Information - The EXPAND CLIST . . . . .                | 146 |

This chapter contains examples of CLISTs that illustrate the CLIST functions described in previous chapters. The examples assume that the CLISTs reside in a PDS allocated to SYSPROC.

Table 9 lists the names of the CLISTs and provides short descriptions of the functions they illustrate. Many of these CLISTs include examples of symbolic variables, control variables, built-in functions, and conditional sequences.

*Table 9. Sample CLISTs and Their Functions*

| CLIST    | Function                                                                                | Page |
|----------|-----------------------------------------------------------------------------------------|------|
| LISTER   | Including TSO/E commands                                                                | 118  |
| DELETEDS | Simplifying routine tasks                                                               | 118  |
| CALC     | Creating arithmetic expressions from user supplied input                                | 119  |
| CALCFTND | Performing front-end prompting                                                          | 119  |
| SCRIPTDS | Initializing and invoking system services                                               | 121  |
| SCRIPTN  | Invoking CLISTs to perform subtasks                                                     | 122  |
| SUBMITDS | Including JCL; performing front-end prompting                                           | 125  |
| SUBMITFQ | Performing substringing; adding flexibility                                             | 125  |
| RUNPRICE | Allowing foreground or background submittal of jobs                                     | 126  |
| TESTDYN  | Providing invoker with options and performing initialization based on options specified | 127  |
| COMPRESS | Simplifying routine, system-related tasks                                               | 129  |
| CASH     | Simplifying invoker's interface to complex applications                                 | 131  |
| PHONE    | Performing I/O; reading records into &SYSDVAL                                           | 132  |
| SPROC    | Using &SYSOUTTRAP and &SYSOUTLINE variables to manage command output                    | 133  |
| PROFILE  | Using ISPF dialog management services in CLISTs to create full-screen applications      | 137  |

Table 9. Sample CLISTs and Their Functions (continued)

| CLIST  | Function                                                                                         | Page |
|--------|--------------------------------------------------------------------------------------------------|------|
| EXPAND | Using LISTDSI statement to allocate a new data set with characteristics of an existing data set. | 146  |

---

## Including TSO/E Commands - The LISTER CLIST

You can organize related activities so that users can simply invoke a CLIST to perform a given task or group of tasks. The simplest example is a CLIST that groups TSO/E commands together.

The LISTER CLIST consists of two TSO/E commands. (See Figure 10.) The LISTCAT command lists all of the entries in the invoker's catalog. The LISTALC command lists the names and status of all data sets allocated to the invoker's user ID. TSO/E displays the output produced by these commands in the same order as that in which it executes the commands. The invoker does not have to enter a command, view its output, then enter another command; all input required from the invoker is supplied at one time.

---

```
listcat
listalc status
```

---

Figure 10. The LISTER CLIST

---

## Simplifying Routine Tasks - The DELETEDS CLIST

One way to simplify routine tasks is to write CLISTs that make the process as interactive as possible. For example, the syntax of the DELETE command could confuse users who simply want to delete some of their data sets. For those users, you could write a CLIST that simplifies the process. The DELETEDS CLIST shown in Figure 11 is an example of such a CLIST. It prompts the invoker for a data set name or a completion indicator.

---

```

/*****
/* THIS CLIST PROMPTS THE USER FOR THE NAMES OF THE DATA */
/* SETS TO BE DELETED, ONE AT A TIME. */
/*****

SET DONE=NO
DO WHILE &DONE=NO
 WRITE Enter the name of the data set you want deleted.
 WRITE Omit the identification qualifier (userid).
 WRITE Do not put the name in quotes.
 WRITE When you are finished deleting all data sets, type an 'f'.
 READ DSN
 IF &DSN = F THEN SET DONE=YES
 ELSE delete &DSN
END
```

---

Figure 11. The DELETEDS CLIST

---

## Creating Arithmetic Expressions from User-Supplied Input - The CALC CLIST

The CALC CLIST, shown in Figure 12, contains a PROC statement that requires three input strings from the invoker:

- A numeric value
- An arithmetic operator
- Another numeric value.

The CLIST creates an arithmetic expression using the positional parameter variables that represent these three values. A WRITE statement displays a message made up of the unevaluated expression, an equal sign, and the evaluated expression. CALC contains no validity-checking statements; therefore, input that does not meet the above requirements causes the &EVAL; built-in function to fail and generate an error code.

---

```
PROC 3 FVALUE OPER LVALUE

/*****
/* DISPLAY THE ENTIRE EQUATION AT THE TERMINAL, INCLUDING THE RESULT */
/* OF THE EXPRESSION. */
/*****

WRITE &FVALUE&OPER&LVALUE = &EVAL(&FVALUE&OPER&LVALUE)
```

---

Figure 12. The CALC CLIST

---

## Using Front-End Prompting - The CALCFTND CLIST

Front-end prompting verifies input data before the CLIST uses it in other statements. For example, the CALC CLIST in Figure 12 assumed that &FVALUE and &LVALUE represented valid numeric values or variables containing valid numeric values. It also assumed that &OPER represented a valid arithmetic operator.

In CALCFTND, shown in Figure 13 on page 120, the CLIST first ensures that &FVALUE is numeric, not character data. The WRITE statement message is tailored to address the possibility that the invoker is including decimal points in the value. The CLIST views such a value as character data, not numeric data. The DO-WHILE-END sequence executes until the invoker supplies a valid numeric value. A similar DO-WHILE-END sequence is provided for &LVALUE;

The verification of &OPER is somewhat more involved. &OPER must be a valid arithmetic operator, one of the following symbols: +, -, \*, /, \*\*, //. Therefore, the condition for the corresponding DO-WHILE-END sequence requires a logical ANDing of comparative expressions. Each expression is true when &OPER does not equal the operator in the expression. When all of the expressions are true, &OPER is not a valid arithmetic operator. To ensure that the CLIST views &OPER and the valid arithmetic operators as character data, enclose them in &STR built-in functions.

## Using Front-End Prompting - The CALCFTND CLIST

---

```
PROC 0 FVALUE() OPER() LVALUE()

/*****
/* IF &FVALUE IS INVALID, CONTINUE PROMPTING THE USER TO ENTER */
/* AN ACCEPTABLE VALUE. */
*****/

CONTROL ASIS /* Allow upper and lower case WRITE statements */

SET &NULL =
DO WHILE &DATATYPE(&FVALUE) ^= NUM
 IF &STR(&FVALUE) = &NULL THEN +
 WRITE Please enter a first value without decimal points &STR(-)
 ELSE +
 DO
 WRITENR Your first value is not numeric. Reenter a number without
 WRITE decimal points &STR(-)
 END
 READ &FVALUE
 END
END

/*****
/* IF &OPER IS INVALID, CONTINUE PROMPTING THE USER TO ENTER */
/* AN ACCEPTABLE VALUE. */
*****/

DO WHILE &STR(&OPER) ^= &STR(+) AND &STR(&OPER) ^= &STR(-) AND +
 &STR(&OPER) ^= &STR(*) AND &STR(&OPER) ^= &STR(/) AND +
 &STR(&OPER) ^= &STR(**) AND &STR(&OPER) ^= &STR(//)
 IF &STR(&OPER) = &NULL THEN +
 DO
 WRITE Please enter a valid arithmetic operator (+,-,*,/,**,//)
 WRITE enclosed in parentheses, for example, (+) or (-).
 END
 ELSE +
 DO
 WRITE Your second value is not a valid operator (+,-,*,/,**,//).
 WRITE Reenter this value, using one of the valid arithmetic
 WRITE operators enclosed in parentheses, for example, (+) or (-).
 END
 READ &OPER
 END
END
```

---

Figure 13. The CALCFTND CLIST (Part 1 of 2)

---

```

/*****
/* IF &LVALUE IS INVALID, CONTINUE PROMPTING THE USER TO ENTER */
/* AN ACCEPTABLE VALUE. */
/*****

DO WHILE &DATATYPE(&LVALUE) ^= NUM
 IF &STR(&LVALUE) = &NULL THEN +
 WRITE Please enter a second value without decimal points &STR(-)
 ELSE +
 DO
 WRITENR Your last value is not numeric. Reenter a number without
 WRITE decimal points &STR(-).
 END
 READ LVALUE
END

/*****
/* ONCE THE OPERANDS HAVE BEEN VERIFIED, EVALUATE THE EXPRESSION AND */
/* DISPLAY THE RESULT AT THE TERMINAL. */
/*****
WRITE &FVALUE&OPER&LVALUE = &EVAL(&FVALUE&OPER&LVALUE)

```

---

Figure 13. The CALCFTND CLIST (Part 2 of 2)

---

## Initializing and Invoking System Services - The SCRIPTDS CLIST

The SCRIPTDS CLIST enables a user to run the SCRIPT program against an input data set and have the output printed.

As shown in Figure 14, SCRIPTDS requires a positional parameter, &DSN; The invoker supplies the name of a PDS member to be printed. The CLIST includes the &DSN variable as the member name of the memo.text data set on the invocation of the SCRIPT program. The invoker does not have to supply input for &SYSPREF because it is a control variable whose value is available to the CLIST. The inclusion of &SYSPREF as the identification qualifier of the input data set frees the invoker from having to enter a fully-qualified data set name. The CLIST also substitutes &SYSPREF and &DSN on the allocation of the output data set so that its name corresponds to the name of the input data set.

---

```

PROC 1 DSN LIST
/*****
/* THIS CLIST (SCRIPTDS) SETS UP THE ENVIRONMENT FOR SCRIPTING A */
/* DATA SET, ISSUES THE SCRIPT COMMAND, AND PRINTS THE OUTPUT. */
/*****
CONTROL NOFLUSH NOMSG
IF &LIST=LIST THEN +
 CONTROL LIST
/*****
/* DELETE THE OUTPUT DATA SET INTO WHICH THE SCRIPTED FILE WILL BE */
/* PLACED IN CASE IT IS STILL ALLOCATED FROM A PREVIOUS INVOCATION */
/* OF SCRIPTDS. */
/*****
delete '&SYSPREF.&DSN.list'

```

---

Figure 14. The SCRIPTDS CLIST (Part 1 of 2)

## Perform Subtasks - The SCRIPTN CLIST

---

```
/* *****
/* DEFINE A FILE NAME (DDNAME) FOR THE OUTPUT DATA SET SO THAT THE */
/* SCRIPT PROGRAM CAN REFERENCE IT. FREE THE FILE BECAUSE SCRIPT WILL*/
/* ALSO ALLOCATE THE DATA SET. */
/* *****
alloc f(a) da('&SYSPREF.&DSN.list') dsorg(ps) recfm(v,b,m) +
 blk(3156) sp(10,10) tr new release reu
free f(a)
CONTROL LIST

/* *****
/* ISSUE THE SCRIPT COMMAND, SPECIFYING THE NAME OF THE DATA SET */
/* MEMBER TO BE SCRIPTED: MEMO.TEXT(&DSN). */
/* *****
script '&SYSPREF.memo.text(&DSN)' +
 message(delay id trace) device(3800n6) twopass +
 profile('script.r3.maclib(ssprof)') +
 lib('script.r3.maclib') +
 sysvar(c 1 d yes) +
 bind(8 8) chars(gt12 gb12) file('&SYSPREF.&DSN.list') continue

/* *****
/* FREE THE FILES REQUIRED TO PRINT THE SCRIPTED DATA SET. */
/* THEN ALLOCATE THEM, REQUESTING TWO COPIES ON THE 3800 PRINTER. */
/* *****
SET RC=&LASTCC /* Get SCRIPT return code */
IF RC<=4 THEN +
DO
 CONTROL NOMSG
 CONTROL MSG
 alloc f(sysprint) dummy reuse
 alloc f(sysut1) da('&SYSPREF.&DSN.list') shr reuse
 alloc f(sysut2) sysout(n) fcb(std4) chars(gt12,gb12) +
 copies(2) optcd(j) reuse
 alloc f(sysin) dummy reuse

/* *****
/* INVOKE THE UTILITY TO HAVE THE DATA SET PRINTED AND FREE THE */
/* FILES. */
/* *****
call 'sys1.linklib(iebgener)'
free f(sysut1,sysut2,sysprint,sysin)
END
```

---

Figure 14. The SCRIPTDS CLIST (Part 2 of 2)

---

## Invoking CLISTs to Perform Subtasks - The SCRIPTN CLIST

While you can write CLISTs that perform application tasks directly, you can also write CLISTs that subdivide application tasks among nested CLISTs and control their execution. For example, you can write a CLIST that invokes two other CLISTs to perform the same tasks as those performed by SCRIPTDS in Figure 14 on page 121.

SCRIPTN, shown in Figure 15 on page 123, produces the same results as SCRIPTDS. The invoker provides a data set name qualifier as done for SCRIPTDS. SCRIPTN defines &DSNAM as a global variable because SCRIPTN invokes two CLISTs that refer to the variable. SCRIPTN invokes a CLIST called SCRIPTD, which includes the &DSNAM variable as the member name of the memo.text data set on the invocation of the SCRIPT command (See Figure 16 on page 123). When finished with these tasks, SCRIPTD returns control to SCRIPTN and execution continues at the command following the invocation of SCRIPTD. This command is

## Perform Subtasks - The SCRIPTN CLIST

the invocation of a CLIST called OUTPUT (See Figure 17 on page 124). OUTPUT performs the required allocations to invoke the IEBGENER utility to print the output data set.

---

```
PROC 1 DSN
GLOBAL DSNAM
SET DSNAM=&DSN
IF &LENGTH(&DSN) LE 8 AND /* ENSURE VALID NAME AND */ +
 &DATATYPE(&SUBSTR(1,&DSN))=CHAR THEN /* VALID FIRST CHARACTER */ +
 DO

 /******
 /* INVOKE THE SCRIPTD CLIST TO SET UP THE ENVIRONMENT REQUIRED TO */
 /* SCRIPT THE INPUT DATA SET AND THEN EXECUTE THE SCRIPT COMMAND. */

 /******
 %scriptd
 /******

 /* INVOKE THE OUTPUT CLIST TO PRINT 2 COPIES OF THE SCRIPTED */
 /* DATA SET ON THE 3800 PRINTER. */
 /******

 IF &LASTCC<=4 THEN /* Test return code from SCRIPTD */ +
 DO
 %output
 END
 ELSE WRITE SCRIPTD FAILED
 END
 ELSE +
 WRITE The name entered must be less than 9 characters long and +
 the first character must not be numeric.
```

---

Figure 15. The SCRIPTN CLIST

---

```
GLOBAL DSNAM

/******
/* THIS CLIST (SCRIPTD) SETS UP THE ENVIRONMENT FOR SCRIPTING A */
/* DATA SET PROVIDED BY THE USER AND ISSUES THE SCRIPT COMMAND. */
/******

CONTROL NOFLUSH NOMSG
ERROR +
DO /* If an error occurs,
 SET RC=&LASTCC /* get return code
 EXIT CODE(&RC)/* and pass control back to SCRIPTN
END
```

---

Figure 16. The SCRIPTD CLIST (Part 1 of 2)

## Perform Subtasks - The SCRIPTN CLIST

---

```
/* ***** */
/* DELETE THE OUTPUT DATA SET INTO WHICH THE SCRIPTED FILE WILL BE */
/* PLACED IN CASE IT IS STILL ALLOCATED FROM A PREVIOUS INVOCATION */
/* OF SCRIPTN. */
/* ***** */

delete '&SYSPREF.&DSNAM.list'

/* ***** */
/* DEFINE THE OUTPUT DATA SET SO THAT THE SCRIPT PROGRAM CAN REFERENCE*/
/* IT. FREE THE FILE BECAUSE SCRIPT WILL ALSO ALLOCATE THE DATA SET */
/* ***** */

alloc f(a) da('&SYSPREF.&DSNAM.list') dsorg(ps) recfm(v,b,m) +
 blk(3156) sp(50,30) tr new release reu
free f(a)
CONTROL LIST

/* ***** */
/* ISSUE THE SCRIPT COMMAND, SPECIFYING THE NAME OF THE DATA SET */
/* MEMBER TO BE SCRIPTED: MEMO.TEXT(&DSNAM). */
/* THEN RETURN CONTROL TO SCRIPTN. */
/* ***** */

script '&SYSPREF.memo.text(&DSNAM)' +
 message(delay id trace) device(3800n6) twopass +
 profile('script.r3.maclib(ssprof)') +
 lib('script.r3.maclib') +
 sysvar(c 1 d yes) +
 bind(8 8) chars(gt12 gb12) file('&SYSPREF.&DSNAM.list') continue
```

---

Figure 16. The SCRIPTD CLIST (Part 2 of 2)

---

```
GLOBAL DSNAM

/* ***** */
/* THIS CLIST (OUTPUT) FREES FILES REQUIRED TO PRINT THE SCRIPTED */
/* DATASET, ALLOCATES THEM REQUESTING TWO COPIES ON THE 3800 */
/* PRINTER, AND INVOKES IEBGENER TO HAVE THEM PRINTED. */
/* ***** */

CONTROL NOMSG
CONTROL MSG
alloc f(sysprint) dummy reuse
alloc f(sysut1) da('&SYSPREF.&DSNAM.LIST') shr reuse
alloc f(sysut2) sysout(n) fcb(std4) chars(gt12,gb12) +
 copies(2) optcd(j) reuse
alloc f(sysin) dummy reuse

/* ***** */
/* INVOKE THE UTILITY TO HAVE THE DATA SET PRINTED AND FREE THE */
/* FILES. THEN RETURN CONTROL TO SCRIPTN. */
/* ***** */

call 'sys1.linklib(iebgener)'
free f(sysut1,sysut2,sysprint,sysin)
```

---

Figure 17. The OUTPUT CLIST

---



---

## Including JCL Statements - The SUBMITDS CLIST

You can include job control language (JCL) statements in CLISTs. The SUBMITDS CLIST, shown in Figure 18, uses the SUBMIT \* command to indicate that the JCL statements immediately follow the command.

SUBMITDS verifies job card information using front-end prompting and then submits a job that copies one data set into another. The validity-checking does not go beyond verifying that the account number is a four-digit number.

Because an account number may contain leading zeros that are ignored by the &LENGTH built-in function, the CLIST uses the &STR built-in function in the evaluation of the length of &ACCT.

The SUBMITDS CLIST assumes that:

- The account number is required and must be a four-digit number.
- The account number may contain leading zeros.
- The default CLASS for the job is C.

---

```

PROC 2 DSN ACCT CLASS(C)

/*****
/* IF &ACCT IS INVALID, CONTINUE PROMPTING UNTIL THE USER ENTERS */
/* AN ACCEPTABLE VALUE. */
/*****

DO WHILE &LENGTH(&STR(&ACCT)) <= 4 OR &DATATYPE(&ACCT) <= NUM
 WRITE Your account number is invalid.
 WRITE Reenter a four-digit number.
 READ ACCT
END

/*****
/* ONCE ACCOUNT NUMBER HAS BEEN VERIFIED, SUBMIT THE JOB. */
/*****

SET SLSHASK=&STR(/*) /* Set the /* required for jcl comment statement */
SUBMIT * END($$)
//&SYSUID1 JOB &ACCT,&SYSUID,CLASS=&CLASS,NOTIFY=&SYSUID
/&SLSHASK THIS STEP COPIES THE INPUT DATASET TO SYSOUT=A
//COPY EXEC PGM=COPYDS
//SYSUT1 DD DSN=&SYSUID.&DSN,DISP=SHR;
//SYSUT2 DD SYSOUT=A
$$

```

---

Figure 18. The SUBMITDS CLIST

---

## Analyzing Input Strings with &SUBSTR - The SUBMITFQ CLIST

You can use the &SUBSTR built-in function to analyze input from the invoker and to modify the input if necessary.

The SUBMITFQ CLIST, shown Figure 19 on page 126, determines whether the data set name supplied by the invoker is a fully-qualified name or not. If the data set name is not fully qualified (does not include a user ID), the SUBMITFQ adds the user ID and submits the data set name in the correct form on a JCL statement.

## Analyzing Input Strings - The SUBMITFQ CLIST

SUBMITFQ determines whether the data set name is fully qualified by comparing the first character in &DSN to a single quote ('). If the logical comparison is true, the CLIST assumes a fully-qualified data set name and removes the quotes. (Unlike on the ALLOCATE command, fully-qualified data set names are not enclosed in single quotes on JCL statements.) If the first character of &DSN is not a single quote, the CLIST assumes the data set name is not fully qualified and prefixes the character string "&SYSUID." to the value of &DSN. In either case, &DSN contains a fully-qualified data set name when referred to in the SYSUT1 JCL statement.

---

```
PROC 2 DSN ACCT CLASS(C)

/*****
/* IF &ACCT IS INVALID, CONTINUE PROMPTING UNTIL THE USER ENTERS */
/* AN ACCEPTABLE VALUE. */
*****/

DO WHILE &LENGTH(&STR(&ACCT)) <= 4 OR &DATATYPE(&ACCT) <= NUM
 WRITE Your account number is invalid.
 WRITE Reenter a four-digit number.
 READ ACCT
END

/*****
/* IF THE DATA SET IS FULLY QUALIFIED, REMOVE THE QUOTES. OTHERWISE, */
/* PREFIX THE CURRENT USERID. */
*****/

IF &STR(&SUBSTR(1,&DSN)) = ' THEN +
 SET DSN = &STR(&SUBSTR(2:&LENGTH(&DSN)-1,&DSN))
ELSE SET DSN=&STR(&SYSUID.&DSN)
WRITE &DSN

/*****
/* ONCE ACCOUNT NUMBER HAS BEEN VERIFIED, SUBMIT THE JOB. */
*****/

SET SLASHASK=&STR(/) /* Set the / req. for the jcl comment statement */
SUBMIT * END($$)
//&SYSUID1 JOB &ACCT,&SYSUID,CLASS=&CLASS
/&SLASHASK THIS STEP COPIES THE INPUT DATASET TO SYSOUT=A
//COPY EXEC PGM=COPYDS
//SYSUT1 DD DSN=&DSN,DISP=SHR;
//SYSUT2 DD SYSOUT=A
$$
```

---

Figure 19. The SUBMITFQ CLIST

---

## Allowing Foreground and Background Execution of Programs - The RUNPRICE CLIST

You can write CLISTs that invoke programs in either the foreground or the background. By creating a background job, the CLIST can have the job invoke any program, including itself, in the background. You can use this type of a CLIST to enable users who are unfamiliar with JCL to submit programs. By placing the JCL in a CLIST, you simplify the user's work, while adding greater range to the tasks the user can perform. The RUNPRICE CLIST, shown in Figure 20 on page 127, illustrates this type of a CLIST.

RUNPRICE either executes a COBOL program called APRICE in the foreground or submits a job that executes APRICE in the background. The CLIST determines

which type of invocation to perform based on whether the invoker includes the BATCH keyword on the invocation of RUNPRICE.

---

```

PROC 0 M(R) BATCH

/*****
/* THIS CLIST (RUNPRICE) SUBMITS A JOB FOR EXECUTION EITHER IN THE */
/* FOREGROUND OR BACKGROUND, BASED ON WHETHER THE INVOKER INDICATES */
/* 'BATCH' ON THE INVOCATION. THE MESSAGE CLASS DEFAULTS TO 'R', */
/* THOUGH THE INVOKER MAY CHANGE IT. */
/*****
CONTROL END(ENDO)
/*****
/* IF &BATCH DOES NOT EQUAL A NULL, THIS INDICATES THAT THE INVOKER */
/* INCLUDED THE KEYWORD ON THE INVOCATION. IN THIS CASE, THE INVOKER*/
/* WANTS THE JOB SUBMITTED IN THE BACKGROUND, SO CREATE A JOB THAT */
/* EXECUTES THE TMP AND THEN INVOKES RUNPRICE WITHOUT THE 'BATCH' */
/* KEYWORD. ON THIS SECOND INVOCATION OF RUNPRICE, ONLY THE */
/* APRICE PROGRAM IS EXECUTED. */
/* IF &BATCH EQUALS A NULL, THIS INDICATES THAT THE INVOKER WANTS */
/* TO EXECUTE THE PROGRAM IN THE FOREGROUND. IN THIS CASE, SIMPLY */
/* INVOKE THE APRICE PROGRAM DIRECTLY. */
/*****
SET SLSHASK=&STR(/*) /* Set the /* for JOBPARM to a variable */
IF &BATCH=BATCH THEN +
DO
 CONTROL NOMSG
 SUBMIT * END(NN)
 //STEVE1 JOB 'accounting info','STEVE',
 // MSGLEVEL=(1,1),CLASS=T,NOTIFY=&SYSUID,MSGCLASS=&M,
 // USER=???????,PASSWORD=??????
 &SLSHASK JOBPARM COPIES=1
 //BACKTMP EXEC PGM=IKJEFT01,REGION=4096K,DYNAMNBR=10
 //SYSPRINT DD DUMMY
 //SYSTSPRT DD SYSOUT=*
 //SYSTSIN DD *
 ex 'd84r1h1.tsoer2.pubs.clist(runprice)'
 NN
 ENDO
ELSE call 'd60fot1.allot.cobol(aprice)'

```

---

Figure 20. The RUNPRICE CLIST

---

## Including Options - The TESTDYN CLIST

You can code options in a CLIST so that the CLIST performs different functions depending on what the invoker specifies.

The TESTDYN CLIST, shown in Figure 21 on page 128, sets up the environment needed to execute a program called PARMTEST, which tests dynamic allocation input parameters entered from the terminal. In TESTDYN, conditional IF-THEN-ELSE sequences and optional keywords on the PROC statement enable the invoker to select a number of options when invoking the CLIST. For example, one option is whether or not the invoker wants the system messages that PARMTEST produces sent to a data set rather than to the terminal. TESTDYN includes a keyword parameter, SYSPRINT, on its PROC statement and assigns it a default value of \*, which sends system messages to the terminal. The invoker can override that default value and have system messages sent to a system output data set.

## Including Options - The TESTDYN CLIST

Note that special considerations are taken in the processing that determines whether SYSOUT has been coded for SYSPRINT. On the IF statement, the variable &SYSPRINT is enclosed in a &STR built-in function because &SYSPRINT defaults to an asterisk, which the CLIST views as a multiplication operator. The &STR built-in function defines the asterisk as character data and prevents the CLIST from using it arithmetically.

---

```
PROC 0 MBR(PARMTST) SYSPRINT(*) SYSLIB(LOAD) OUTFILE(VLDPARMS) LISTDSETS

/*****/
/* THIS CLIST SETS UP THE ENVIRONMENT NEEDED FOR EXECUTION OF */
/* A PROGRAM NAMED 'PARMTST' WHICH TESTS DYNAMIC ALLOCATION */
/* INPUT PARAMETERS ENTERED FROM THE TERMINAL. */
/*****/

/*****/
/* IF THE USER REQUESTED THAT DATA SETS BE LISTED, LIST THEM. */
/*****/

IF &LISTDSETS = LISTDSETS THEN +
DO
WRITE PROGRAM: &MBR
WRITE SYSPRINT: &SYSPRINT
WRITE SYSLIB: &SYSLIB
WRITE OUTFILE: &OUTFILE
END

/*****/
/* IF THE USER REQUESTED THAT SYSTEM MESSAGES BE SENT TO A SYSTEM */
/* OUTPUT DATA SET, ALLOCATE SYSPRINT TO SYSOUT. OTHERWISE, */
/* ALLOCATE SYSPRINT TO THE DATA SET NAME (OR TERMINAL) AS */
/* INDICATED BY THE USER. */
/*****/

IF &STR(&SYSPRINT) = SYSOUT THEN +
alloc f(sysprint) sysout reu
ELSE alloc f(sysprint) da(&SYSPRINT) reu

/*****/
/* ALLOCATE THE SYSTEM LIBRARY, WHETHER IT BE THE DEFAULT (LOAD) */
/* OR ANOTHER LIBRARY. */
/*****/

alloc f(syslib) da(&SYSLIB) reu shr
```

---

Figure 21. The TESTDYN CLIST (Part 1 of 2)

## Simplifying System-Related Tasks - The COMPRESS CLIST

---

```
/* ***** */
/* ALLOCATE THE OUTPUT DATA SET FOR THE PROGRAM. ALLOCATE THE */
/* INPUT DATA SET TO THE TERMINAL. */
/* ***** */

alloc f(outfile) da(&OUTFILE) lrecl(121) blksize(1210) recfm(f,b) reu
alloc f(sysin) da(*) reu

/* ***** */
/* CALL PARMTEST AND NOTIFY THE USER THAT THE INVOCATION WAS */
/* SUCCESSFUL OR UNSUCCESSFUL. */
/* ***** */

CONTROL NOFLUSH
call 'steve.lib.load(&MBR)'
IF &LASTCC = 0 THEN +
 WRITE &MBR invoked successfully at &SYSTIME on &SYSDATE
ELSE +
 WRITE &MBR invoked unsuccessfully at &SYSTIME on &SYSDATE
```

---

Figure 21. The TESTDYN CLIST (Part 2 of 2)

---

## Simplifying System-Related Tasks - The COMPRESS CLIST

From time to time, users must compress a data set they have updated multiple times to free some space for additional members. The process involves allocating the data sets required by the IEBCOPY utility, which performs the copying involved in compressing the data set, and invoking the utility.

The COMPRESS CLIST, shown in Figure 22 on page 130, performs all of the functions required to compress a data set.

The COMPRESS CLIST includes special procedures to make the best use of storage space. For example, COMPRESS could allocate a data set to contain the input required by the IEBCOPY utility. However, IEBCOPY requires only the following command for input:

```
copy indd=output,outdd=output
```

Rather than waste permanent storage for the one command, COMPRESS creates a virtual I/O (VIO) data set for the SYSIN file using an ALLOCATE command that does not specify a data set name. The ALLOCATE command assigns the file name SYSIN to the VIO data set and then writes a record containing the COPY command to the SYSIN file.

## Simplifying System-Related Tasks - The COMPRESS CLIST

---

```
PROC 1 DSNNAME DISP(OLD) LIST
CONTROL NOFLUSH /* Preserve the input stack for errors */

/*****
/* THIS CLIST (COMPRESS) COMPRESSES A DATA SET AND INFORMS THE USER */
/* WHETHER OR NOT THE COMPRESS WAS SUCCESSFUL. */
/*****
/* SET UP AN ERROR ROUTINE TO FREE ALLOCATED FILES WHEN AN ERROR OCCURS.
/*****

ERROR +
DO
 ERROR OFF
 WRITE An error has occurred prior to the actual compress.
 free file(sysin,sysprint,sysut3,sysut4,output)
 GOTO FINISH
END

/*****
/* IF THE USER WANTS TO VIEW THE TSO COMMANDS AS THEY EXECUTE, ISSUE */
/* THE CONTROL LIST STATEMENT. */
/*****

IF &LIST=LIST THEN +
 CONTROL LIST

/*****
/* ESTABLISH ENVIRONMENT NEEDED BY IEBCOPY UTILITY. */
/*****

allocate file(sysin) space(1,1) track lrecl(80) recfm(f) blksize(80) reuse
IF &SYSDSN(COMPRESS;LIST) = OK THEN +
 allocate file(sysprint) dataset(compress.list) recfm(f,b,a) +
 lrecl(121) blksize(12947) space(1,1) track reuse
ELSE +
 allocate file(sysprint) dataset(compress.list) shr reuse
 allocate file(sysut3) unit(sysda) space(1,1) cylinders reu
 allocate file(sysut4) unit(sysda) space(1,1) cylinders reu
 allocate file(output) dataset(&DSNAME) &DISP reu

/*****
/* PLACE THE COPY COMMAND INTO THE SYSIN FILE REQUIRED BY IEBCOPY. */
/*****

OPENFILE SYSIN OUTPUT
SET SYSIN = &STR(COPY INDD=OUTPUT,OUTDD=OUTPUT)
PUTFILE SYSIN
CLOSEFILE SYSIN
```

---

Figure 22. The COMPRESS CLIST (Part 1 of 2)

```
/* Set up an error routine to notify user of compress errors. */
/*****
ERROR +
DO
 WRITE Compress error--Details in '&SYSPREF compress.list'
 GOTO FINISH
END
/*****
/* INVOKE IEBCOPY UTILITY TO PERFORM THE COMPRESS. */
/*****

tsoexec call 'sys1.linklib(iebcopy)' 'size=512k'
 WRITE &DSNAME compressed at &SYSTIME
FINISH: end /* End the CLIST */
```

---

Figure 22. The COMPRESS CLIST (Part 2 of 2)

---

## Simplifying Interfaces to Applications - The CASH CLIST

You may have access to applications written in other programming languages. However, the interfaces required to invoke these programs may not be easily mastered by users who use the system infrequently. Rather than write new applications, you can write CLISTs that act as intermediaries between users and such programs.

For example, a program called CASHFLOW creates and prints weekly and monthly reports. If the invoker wants a weekly report, the invocation is:

```
call 'sys1.plib(cashflow)' 'a,,38,ccfdacr'
```

If the invoker wants a monthly report, the invocation is:

```
call 'sys1.plib(cashflow)' 'x,,49,ccfmacr'
```

Not only are the preceding invocations quite technical, they are difficult to remember.

CASHFLOW also requires the allocation of a file. For weekly reports, it requires:

```
alloc f(projwkly) da(weekly) shr
```

For monthly reports, it requires:

```
alloc f(projmtly) da(monthly) shr
```

To simplify the process of invoking CASHFLOW, the CASH CLIST, shown in "Simplifying Interfaces to Applications - The CASH CLIST", performs the following intermediary tasks:

1. It determines whether the invoker wants a weekly or monthly report.
2. It assigns values to the variables substituted in the parameter string on the CALL command that invokes CASHFLOW. The values correspond to the parameters required for the type of report requested.
3. It allocates the appropriate data set.

## Using &SYSDVAL When Performing I/O ...

---

```
/* PROMPT THE USER FOR THE WORD 'WEEKLY' or 'MONTHLY' */
DO WHILE &TYPE≠WEEKLY AND &TYPE≠MONTHLY
 WRITE Enter the word WEEKLY or MONTHLY to indicate the
 WRITE type of report you want to create.
 READ TYPE
END
/*****/
/* NOW THAT A VALID REQUEST HAS BEEN ESTABLISHED, ALLOCATE THE */
/* APPROPRIATE DATA SET, ASSIGN THE APPROPRIATE VALUES TO CALL */
/* COMMAND PARAMETER VARIABLES, AND INVOKE CASHFLOW. */
/*****/

IF &TYPE=WEEKLY THEN +
 DO
 alloc f(projwkly) da(weekly) shr
 SET INVOKE=38
 SET CHAR=a
 SET OPT=ccfdacr
 END
ELSE +
 DO
 alloc f(projmtly) da(monthly) shr
 SET INVOKE=49
 SET CHAR=x
 SET OPT=ccfmacr
 END
call 'sys1.plib(cashflow)' '&CHAR,,&INVOKE,&OPT'
```

---

Figure 23. The CASH CLIST

---

## Using &SYSDVAL When Performing I/O - The PHONE CLIST

Data records often contain related pieces or blocks of information. For instance, a sequential record could contain a person's name and phone number. When you read records of this type, you may want to separate the blocks of information. By defining SYSDVAL as the file name of the data set containing the records, you read each record into SYSDVAL, which the CLIST equates with the &SYSDVAL control variable. Then you can issue a READDVAL statement that contains the names of the variables into which you want the blocks of information stored.

The PHONE CLIST, shown in Figure 24 on page 133, takes advantage of this technique. PHONE receives a last name as input using a positional parameter called NAME. PHONE then allocates a data set called SYS1.STAFF.DIRECTRY and assigns it the file name SYSDVAL. Each record in SYS1.STAFF.DIRECTRY contains a last name, followed by a blank and a phone number. Sample records are:

```
PICKERELL 555-5555
GORGEN 555-4444
```

PHONE sets the first character string in the record to a variable called &LNAME and sets the second string to a variable called &PHONUMBR. Then, it compares &NAME to &LNAME and, if they are equal, displays the corresponding phone number (contained in &PHONUMBR) at the terminal. If the names are not equal, PHONE reads another record and performs the same test.

If none of the names in the directory match the name supplied by the invoker, the CLIST branches to the end-of-file error routine. The end-of-file routine informs the



## Using &SYSDVAL When Performing I/O ...

invoker that a name was not found, and sets the variable DONE=YES to cause the loop to terminate.

---

```
PROC 1 NAME

/*****
/* THIS CLIST (PHONE) SEARCHES A DATA SET FOR A NAME THAT MATCHES THE */
/* NAME SUPPLIED TO THE CLIST. IF A MATCH IS FOUND, THE CORRESPONDING */
/* PHONE NUMBER IS DISPLAYED AT THE TERMINAL. OTHERWISE, A MESSAGE IS */
/* ISSUED INFORMING THE USER THAT A MATCH WAS NOT FOUND. */
*****/

/*****
/* ALLOCATE THE INPUT DATA SET FOR THE CLIST. */
*****/

alloc f(sysdval) da('sys1.staff.directry') shr reu

/*****
/* OPEN THE FILE, AND SET UP AN ERROR ROUTINE TO HANDLE END-OF-FILE. */
*****/

CONTROL NOMSG NOFLUSH
ERROR +
DO
 IF &LASTCC = 400 THEN +
 DO
 WRITENR The name requested, &NAME, was not found in the staff
 WRITE directory.
 SET DONE=YES
 END
 RETURN
END /* END OF END-OF-FILE ROUTINE */
SET DONE=NO
OPENFILE SYSDVAL

/*****
/* THIS LOOP RETRIEVES RECORDS FROM THE INPUT DATA SET UNTIL A MATCH */
/* IS FOUND OR END OF FILE IS REACHED. IF A MATCH IS FOUND, THE */
/* SECOND VARIABLE ON THE READDVAL STATEMENT (THE ONE CONTAINING */
/* THE PHONE NUMBER) IS DISPLAYED. */
*****/

DO WHILE &DONE=NO
 GETFILE SYSDVAL
 READDVAL LNAME PHONUMBR
 IF &STR(&NAME) = &STR(&LNAME) THEN +
 DO
 WRITE &PHONUMBR
 SET DONE=YES
 END
 END
CLOSFILE SYSDVAL
free file(sysdval)
```

---

Figure 24. The PHONE CLIST

---

## Allocating Data Sets to SYSPROC - The SPROC CLIST

The SPROC CLIST allocates a CLIST data set to the file SYSPROC, so users can implicitly execute CLISTs that are in that data set. The SPROC CLIST allocates the CLIST data set as the first in the list of data sets allocated to SYSPROC, so TSO/E searches that data set for CLISTs before searching any of the others.

## Allocating Data Sets to SYSPROC - The SPROC CLIST

**Note:** You can also use the ALTLIB command to define CLIST data sets and establish their search order for implicit execution.

SPROC performs the following steps: finds all data sets currently allocated to SYSPROC and concatenates them; then adds the invoker's data set to the beginning of the concatenation and allocates the concatenation to SYSPROC.

The CLIST, shown in "Allocating Data Sets to SYSPROC - The SPROC CLIST" on page 133, uses &SYSOUTTRAP to intercept the output from the LISTALC STATUS command and saves the command output in &SYSOUTLINE $nn$  variables. The output produced by the LISTALC STATUS command is formatted as follows:

```
--DDNAME---DISP--
DATA-SET-NAME1
 FILE-NAME1 DISPOSITION
DATA-SET-NAME2
 FILE-NAME2 DISPOSITION
DATA-SET-NAME3
 DISPOSITION
DATA-SET-NAME4
 FILE-NAME3 DISPOSITION
```

In the previous format, DATA-SET-NAME1 is allocated to FILE-NAME1; DATA-SET-NAME2 and DATA-SET-NAME3 are allocated to FILE-NAME2; and DATA-SET-NAME4 is allocated to FILE-NAME3. The name of a file always begins in the third position, whereas a data set name begins in the first position of the output line. SPROC does the following:

1. Loops through &SYSOUTLINE $nn$  variables until either the string SYSPROC is found or until all output has been searched. (It is possible no data sets are allocated to SYSPROC.)
2. If SYSPROC is found, SPROC sets a variable to the name of the previous data set in the list and encloses it in single quotes.
3. Begins with the &SYSOUTLINE $nn$  variable three lines after the one containing the name of the first data set allocated to SYSPROC. This line either contains a new file name, in which case SPROC has found all data sets allocated to SYSPROC, or it contains the disposition of the next data set in the concatenation. By setting a variable to three blanks, SPROC determines the contents of the line.

If the line contains a disposition, SPROC decreases &SYSOUTLINE $nn$  by one to get the data set name and add it to the variable (&CONCAT) representing the data sets in the new concatenation. SPROC repeats this procedure until another file name is encountered or until all command output has been searched. After all data sets have been added to the concatenation list, SPROC issues the ALLOCATE command, adding the user's data set name to the beginning of the concatenation list.

SPROC contains an error routine to handle allocation errors should they occur. SPROC may itself be allocated to SYSPROC, in which case the user can invoke SPROC implicitly. However, if the CLIST fails after it frees the SYSPROC file, but before it is able to re-establish the concatenation, the user cannot re-invoke SPROC implicitly without first logging off and logging on again.

## Allocating Data Sets to SYSPROC - The SPROC CLIST

---

```
PROC 0 LIST
 IF &LIST=LIST THEN +
 CONTROL LIST CONLIST
 /*****/
 /* THIS CLIST (SPROC) CONCATENATES DATA SETS AND ALLOCATES THEM */
 /* TO THE FILE SYSPROC. */
 /* THE USER IS PROMPTED TO SUPPLY THE NAME OF THE DATA */
 /* SET TO BE ADDED TO THE BEGINNING OF THE CONCATENATION. */
 /*****/
 /*****/
 /* IF ALLOCATION FAILS, TELL THE USER TO LOG OFF, LOG ON, AND, IF */
 /* DESIRED, TRY EXECUTING SPROC AGAIN. */
 /*****/
 CONTROL NOFLUSH
 ERROR +
 DO
 WRITE An error has been encountered in the SYSPROC concatenation.
 WRITE Please log off, then log on again, and, if desired, re-invoke
 WRITE SPROC. If the problem persists, see your system programmer.
 GOTO OUT
 END
 /*****/
 /* PROMPT THE USER FOR THE NAME OF THE DATA SET TO BE ADDED TO THE */
 /* BEGINNING OF THE SYSPROC CONCATENATION. */
 /*****/
 WRITE Enter the fully-qualified data set name you want
 WRITE added to the beginning of the SYSPROC concatenation.
 WRITE Do N O T place quotes around the dataset name.
 READ ADD
```

---

Figure 25. The SPROC CLIST (Part 1 of 3)

## Allocating Data Sets to SYSPROC - The SPROC CLIST

---

```
/* ***** */
/* SET A VARIABLE TO THREE BLANKS. THIS VARIABLE IS USED TO CHECK */
/* THE LISTALC COMMAND OUTPUT FOR THE BEGINNING OF A DIFFERENT */
/* FILENAME AFTER SYSPROC DATA SETS HAVE BEEN LISTED. */
/* ***** */
SET BLANKS = &STR()
/* ***** */
/* SET &SYSOUTTRAP TO A LARGE ENOUGH VALUE TO ENSURE THAT ALL OF */
/* THE LINES OF OUTPUT FROM THE LISTALC COMMAND CAN BE VIEWED. */
/* ***** */
SET &SYSOUTTRAP = 300
/* ***** */
/* ISSUE THE LISTALC STATUS COMMAND AND LOOP THROUGH THE VARIABLES */
/* CONTAINING THE OUTPUT LINES UNTIL THE LINE CONTAINING */
/* THE FILENAME */
/* SYSPROC IS FOUND OR UNTIL ALL LINES HAVE BEEN VIEWED. */
/* (ALL LINES HAVE BEEN VIEWED WHEN A NULL LINE IS RETURNED.) */
/* AN AUXILIARY VARIABLE MUST BE CREATED (&DSN) TO LOOP THROUGH */
/* &SYSOUTLINE&I REPRESENTS THE VALUE OF nn. */
/* NOTE THAT, TO SET &DSN TO &SYSOUTLINE, TWO AMPERSANDS */
/* MUST BE PLACED BEFORE SYSOUTLINE TO AVOID SYMBOLIC SUBSTITUTION */
/* OF &SYSOUTLINE */
/* IF SYSPROC IS FOUND, SET THE VARIABLE &CONCAT EQUAL TO */
/* THE PREVIOUS LINE (CONTAINING THE NAME */
/* OF THE FIRST DATA SET ALLOCATED TO SYSPROC). */
/* ***** */

lista st
SET &SYSOUTTRAP = 0
SET SPROC = &STR(SYSPROC)
SET FOUND = NO
SET I=1
DO WHILE &STR(&FOUND) = NO AND &I <= &SYSOUTLINE
 SET DSN = &SYSOUTLINE&I
 IF &LENGTH(&STR(&DSN)) >=9 THEN +
 IF &STR(&SUBSTR(3:9,&DSN)) = &SPROC THEN +
 DO
 SET FOUND = YES
 SET I = &I-1;
 SET DSN = &&SYSOUTLINE&I
 SET CONCAT = '&DSN'
 END
 ELSE SET I = &I+1
 ELSE SET I = &I+1
END
```

---

Figure 25. The SPROC CLIST (Part 2 of 3)

```

/*****
/* IF SYSPROC WAS FOUND, LOOP THROUGH DATA SETS UNTIL ANOTHER
/* FILENAME IS ENCOUNTERED OR UNTIL THE REST OF THE OUTPUT HAS
/* BEEN PROCESSED. SETTING &I = &I+3 MAPS &DSN TO THE LINE AFTER
/* THE NEXT DATA SET NAME, WHICH WILL CONTAIN ANOTHER FILENAME IF
/* WE HAVE ALREADY PROCESSED THE LAST DATA SET ALLOCATED TO SYSPROC
/* AND WE HAVE NOT REACHED THE END OF THE COMMAND OUTPUT.
/*****
IF &FOUND=YES THEN +
 DO WHILE &I+3 <= &SYSOUTLINE
 SET I = &I+3;
 SET DSN = &&SYSOUTLINE&I
 IF &STR(&SUBSTR(1:3,&DSN)) = &BLANKS THEN +
 DO
 SET I = &I-1
 SET DSN = &&SYSOUTLINE&I
 SET CONCAT = &CONCAT&STR(')&DSN'
 END
 ELSE +
 SET I=&SYSOUTLINE
 END
/*****
/* WHEN ALL DATA SETS ALLOCATED TO SYSPROC HAVE BEEN ADDED TO THE
/* VARIABLE &CONCAT, ADD THE USER'S DATA SET TO THE BEGINNING OF
/* THE CONCATENATION. (INSERT THE VARIABLE &ADD BEFORE &CONCAT)
/* THIS CLIST ASSUMES THAT THE DATA SET HAS BEEN ENTERED CORRECTLY
/* BY THE USER.
/*****
alloc f(sysproc) da('&ADD' &CONCAT) shr reu
OUT: end

```

Figure 25. The SPROC CLIST (Part 3 of 3)

## Writing Full-Screen Applications Using ISPF Dialogs - The PROFILE CLIST

The CLIST language is well-suited for applications that invoke ISPF dialog management services to display full-screen panels. For more information about ISPF, see *z/OS ISPF User's Guide Volume I*.

The PROFILE CLIST is an example of a CLIST that displays entry panels on which the user can modify information. The PROFILE CLIST allows the user to perform any of the following functions to modify his or her profiles:

- Set terminal characteristics.
- Set LOG/LIST parameters.
- Set PF keys (1-12).
- Set PF keys (13-24).

The PROFILE CLIST receives control from a CLIST that displays the primary selection panel. The primary selection panel prompts the user to indicate which function is being requested (QCMD); and if the function is setting PF keys, which PF keys are to be viewed (QKEYS). Then, the CLIST invokes PROFILE, passing the values for QCMD and QKEYS.

PROFILE determines which selection was requested by referencing PROC statement keywords called QCMD and QKEYS.

If &QCMD is 1, PROFILE displays the terminal characteristics panel definition.

## Applications with ISPF - PROFILE CLIST

If &QCMD is 2, PROFILE displays the LOG/LIST parameters panel definition.

If &QCMD is 3 and &QKEYS is 12, PROFILE displays the PF keys 1-12 panel definition.

If &QCMD is 3 and &QKEYS is 24, PROFILE displays the PF keys 13-24 panel definition.

Panels are displayed using the ISPEXEC command.

When the user presses the END key after viewing and/or modifying a particular panel, the value of &LASTCC is 8. By testing the value of &LASTCC, PROFILE can determine when the user is finished with the selection.

When the user is viewing one of the two PF key panels, the user can switch to the other panel by pressing the Enter key. PROFILE sets &QKEYS to the PF key (12 or 24) that represents the other panel so that the user can continue to switch back and forth if desired. Pressing Enter re-executes the DO-UNTIL-END sequence, causing PROFILE to test the value of &QKEYS to determine which panel to display. As with the other selection sequences, the PF key sequence ends when the user presses the END key.

Values set or changed on any of the four panels displayed by PROFILE are stored in the corresponding variables on the panel definitions.

Table 10 contains the purpose of, and figures containing, the PROFILE CLIST and its supporting four panel definitions.

*Table 10. Purpose of, and Figures Containing, PROFILE CLIST and Supporting Panels*

| CLIST/Panel | Purpose                        | Figure |
|-------------|--------------------------------|--------|
| PROFILE     | Manage user profile panels     | 26     |
| XYZABC10    | Terminal characteristics panel | 27     |
| XYZABC20    | LOG/LIST parameters panel      | 28     |
| XYZABC30    | PF keys 1-12 panel             | 29     |
| XYZABC40    | PF keys 13-24 panel            | 30     |

---

```

PROC 0 QCMD(1) QKEYS(12)

/*****
/* THIS CLIST (PROFILE) DISPLAYS THE PANEL THAT CONTAINS THE PROFILE */
/* DATA THE USER WANTS TO UPDATE. IT SETS THE FINISH FLAG TO NO AND */
/* THEN DETERMINES WHICH OF THE FOUR POSSIBLE PANELS THE USER NEEDS */
/* DISPLAYED. */
/*****

CONTROL MSG END(ENDO)
SET FINISH = NO

```

---

*Figure 26. The PROFILE CLIST (Part 1 of 2)*

```

/*****
/* IF THE USER WANTS TO UPDATE TERMINAL CHARACTERISTICS, DISPLAY */
/* THE ASSOCIATED PANEL. */
/*****

SELECT
WHEN (&QCMD = 1) +
DO UNTIL (&FINISH = YES)
 ISPEXEC DISPLAY PANEL(XYZABC10) /* Display first panel */
 IF &LASTCC = 8 THEN /* If user presses END, */ +
 SET FINISH = YES /* end panel display */
ENDO

/*****
/* IF THE USER WANTS TO UPDATE LOG/LIST PARAMETERS, DISPLAY */
/* THE ASSOCIATED PANEL. */
/*****

WHEN (&QCMD = 2) +
DO UNTIL (&FINISH = YES)
 ISPEXEC DISPLAY PANEL(XYZABC20) /* Display 2nd panel */
 IF &LASTCC = 8 THEN /* If user presses END, */ +
 SET FINISH = YES /* end panel display. */
ENDO

/*****
/* IF THE USER WANTS TO UPDATE PF KEYS, DETERMINE WHICH GROUP THE */
/* USER WANTS TO UPDATE: 1-12 or 13-24. DISPLAY THE ASSOCIATED PANEL.*/
/*****

WHEN (&QCMD = 3) +
DO UNTIL (&FINISH = YES)
 IF &QKEYS = 12 THEN +
 DO
 ISPEXEC DISPLAY PANEL(XYZABC30) /* Display PF keys 1-12 */
 IF &LASTCC = 8 THEN /* If user presses END, */ +
 SET FINISH = YES /* end panel display. */
 ELSE +
 SET QKEYS = 24 /* If user presses ENTER, */
 ENDO /* display next panel. */
 ELSE +
 DO
 ISPEXEC DISPLAY PANEL(XYZABC40) /* Display PF keys 13-24 */
 IF &LASTCC = 8 THEN /* If user presses END, */ +
 SET FINISH = YES /* end panel display. */
 ELSE +
 SET QKEYS = 24 /* If user presses ENTER, */
 ENDO /* display previous panel. */
 ENDO
ENDO /* End of SELECT statement
/*
/* EXIT ROUTINE
/*
FINAL: +
SET FCODE = 0
EXIT CODE(&FCODE)

```

Figure 26. The PROFILE CLIST (Part 2 of 2)

The panels displayed by the PROFILE CLIST appear on the following pages in panel definition form. In order for the PROFILE CLIST to display them, the panels must be members of a partitioned data set allocated to the file ISPPLIB, for example:

```
allocate file(ispplib) dataset(test.panels)
```





```

)ATTR DEFAULT(%+_)
/* % TYPE(TEXT) INTENS(HIGH) defaults displayed for */
/* + TYPE(TEXT) INTENS(LOW) information only */
/* _ TYPE(INPUT) INTENS(HIGH) CAPS(ON) JUST(LEFT) */
@ TYPE(IINPUT) INTENS(HIGH) PAD(_) CAPS(ON)
)BODY
+ SAMPLE - SET THE LOG/LIST PARAMETERS
%COMMAND ==>_ZCMD +
%

+Type the information where requested, or change the information shown
+by typing over it:
+
+ %LOG %LIST +
+
+ PROCESS OPTION %==>@Z+ @Z+
+ SYSOUT CLASS %==>@Z + @Z +
+ LOCAL PRINTER ID %==>@Z + @Z +
+ LINES PER PAGE %==>@Z + @Z +
+ PRIMARY PAGES %==>@Z + @Z +
+ SECONDARY PAGES %==>@Z + @Z +
+
+
+
+
+
+
+
+
+
+

```

Figure 28. The LOG/LIST Characteristics Panel Definition (XYZABC20) (Part 1 of 2)

## Applications with ISPF - PROFILE CLIST

---

```
)INIT
 .ZVARS = '(ZLOGFDSP,ZLSTFDSP,ZLOGCLA,ZLSTCLA,ZLOGPID,ZLSTPID, +
 ZLOGLIN,ZLSTLIN,ZLOG1PG,ZLST1PG,ZLOG2PG,ZLST2PG) '

)PROC
 IF (&ZCMD ^= ' ') .MSG = ISPZ001 /* INVALID COMMAND */
 VER (&ZLOGFDSP LIST J,L,K,D,' ')
 VER (&ZLSTFDSP LIST J,L,K,D,' ')
 IF (&ZLOGFDSP = J)
 VER (&ZLOGCLA,NB)
 IF (&ZLOGFDSP = L)
 VER (&ZLOGPID,NB)
 IF (&ZLSTFDSP = J)
 VER (&ZLSTCLA,NB)
 IF (&ZLSTFDSP = L)
 VER (&ZLSTPID,NB)
 VER (&ZLOGLIN NB NUM)
 VER (&ZLOGLIN RANGE 1,99)
 VER (&ZLSTLIN NB NUM)
 VER (&ZLSTLIN RANGE 1,99)
 VER (&ZLOG1PG NB NUM)
 VER (&ZLOG1PG RANGE 0,9999)
 VER (&ZLST1PG NB NUM)
 VER (&ZLST1PG RANGE 1,9999)
 VER (&ZLOG2PG NB NUM)
 VER (&ZLOG2PG RANGE 0,9999)
 VER (&ZLST2PG NB NUM)
 VER (&ZLST2PG RANGE 1,9999)
 IF (&ZLOG1PG = 0)
 VER (&ZLOG2PG,NB)
 VER (&ZLOG2PG,RANGE,0,0)
 IF (&ZLOG1PG ^= 0)
 VER (&ZLOG2PG,NB NUM)
 VER (&ZLOG2PG,RANGE,1,9999)
 IF (.MSG ^= ' ')
 .RESP = ENTER
)END
```

---

Figure 28. The LOG/LIST Characteristics Panel Definition (XYZABC20) (Part 2 of 2)

```

)ATTR DEFAULT(%+_)
 /* % TYPE(TEXT) INTENS(HIGH) defaults displayed for */
 /* + TYPE(TEXT) INTENS(LOW) information only */
 /* _ TYPE(INPUT) INTENS(HIGH) CAPS(ON) JUST(LEFT) */
 @ TYPE(IINPUT) INTENS(HIGH) PAD(_) CAPS(ON)
)BODY
+
+ SAMPLE - SET PF KEYS 1-12
%COMMAND ==>_ZCMD +
%
+Type the information where requested, or change the information shown
+by typing over it:
+
+ PF1 %==>@QPF01 +
+ PF2 %==>@QPF02 +
+ PF3 %==>@QPF03 +
+ PF4 %==>@QPF04 +
+ PF5 %==>@QPF05 +
+ PF6 %==>@QPF06 +
+ PF7 %==>@QPF07 +
+ PF8 %==>@QPF08 +
+ PF9 %==>@QPF09 +
+ PF10 %==>@QPF10 +
+ PF11 %==>@QPF11 +
+ PF12 %==>@QPF12 +
+
+
+
+
+
)INIT
IF (&QPF01 = ' ')
 &QPF01 = HELP
IF (&QPF02 = ' ')
 &QPF02 = SPLIT
IF (&QPF03 = ' ')
 &QPF03 = END
IF (&QPF04 = ' ')
 &QPF04 = RETURN
IF (&QPF05 = ' ')
 &QPF05 = RFIND
IF (&QPF06 = ' ')
 &QPF06 = RCHANGE

```

Figure 29. The PF Keys 1-12 Panel Definition (XYZABC30) (Part 1 of 2)

## Applications with ISPF - PROFILE CLIST

---

```
IF (&QPF07 = ' ')
 &QPF07 = UP
IF (&QPF08 = ' ')
 &QPF08 = DOWN
IF (&QPF09 = ' ')
 &QPF09 = SWAP
IF (&QPF10 = ' ')
 &QPF10 = LEFT
IF (&QPF11 = ' ')
 &QPF11 = RIGHT
IF (&QPF12 = ' ')
 &QPF12 = CURSOR
)PROC
IF (&ZCMD ^= ' ') .MSG = ISPZ001
IF (&QPF01 = ' ')
 &QPF01 = HELP
IF (&QPF02 = ' ')
 &QPF02 = SPLIT
IF (&QPF03 = ' ')
 &QPF03 = END
IF (&QPF04 = ' ')
 &QPF04 = RETURN
IF (&QPF05 = ' ')
 &QPF05 = RFIND
IF (&QPF06 = ' ')
 &QPF06 = RCHANGE
IF (&QPF07 = ' ')
 &QPF07 = UP
IF (&QPF08 = ' ')
 &QPF08 = DOWN
IF (&QPF09 = ' ')
 &QPF09 = SWAP
IF (&QPF10 = ' ')
 &QPF10 = LEFT
IF (&QPF11 = ' ')
 &QPF11 = RIGHT
IF (&QPF12 = ' ')
 &QPF12 = CURSOR
IF (.MSG ^= ' ')
 .RESP = ENTER
)END
```

---

Figure 29. The PF Keys 1-12 Panel Definition (XYZABC30) (Part 2 of 2)

```

)ATTR DEFAULT(%+_)
/* % TYPE(TEXT) INTENS(HIGH) defaults displayed for */
/* + TYPE(TEXT) INTENS(LOW) information only */
/* _ TYPE(INPUT) INTENS(HIGH) CAPS(ON) JUST(LEFT) */
@ TYPE(IINPUT) INTENS(HIGH) PAD(_) CAPS(ON)
)BODY
+ SAMPLE - SET PF KEYS 13-24
%COMMAND ==>_ZCMD +
%
+Type the information where requested, or change the information shown
+by typing over it; then, to set PF keys 1-12, press ENTER.
+
+ PF13 %==>@QPF13 +
+ PF14 %==>@QPF14 +
+ PF15 %==>@QPF15 +
+ PF16 %==>@QPF16 +
+ PF17 %==>@QPF17 +
+ PF18 %==>@QPF18 +
+ PF19 %==>@QPF19 +
+ PF20 %==>@QPF20 +
+ PF21 %==>@QPF21 +
+ PF22 %==>@QPF22 +
+ PF23 %==>@QPF23 +
+ PF24 %==>@QPF24 +
+
+
+
+
+

```

Figure 30. The PF Keys 13-24 Panel Definition (XYZABC40) (Part 1 of 2)

## Allocating Data Set with LISTDSI Information - EXPAND CLIST

---

```
)INIT
 IF (&QPF13 = ' ')
 &QPF13 = HELP
 IF (&QPF14 = ' ')
 &QPF14 = SPLIT
 IF (&QPF15 = ' ')
 &QPF15 = END
 IF (&QPF16 = ' ')
 &QPF16 = RETURN
 IF (&QPF17 = ' ')
 &QPF17 = RFIND
 IF (&QPF18 = ' ')
 &QPF18 = RCHANGE
 IF (&QPF19 = ' ')
 &QPF19 = UP
 IF (&QPF20 = ' ')
 &QPF20 = DOWN
 IF (&QPF21 = ' ')
 &QPF21 = SWAP
 IF (&QPF22 = ' ')
 &QPF22 = LEFT
 IF (&QPF23 = ' ')
 &QPF23 = RIGHT
 IF (&QPF24 = ' ')
 &QPF24 = CURSOR
)PROC
 IF (&ZCMD ^= ' ') .MSG = ISPZ001
 IF (&QPF13 = ' ')
 &QPF13 = HELP
 IF (&QPF14 = ' ')
 &QPF14 = SPLIT
 IF (&QPF15 = ' ')
 &QPF15 = END
 IF (&QPF16 = ' ')
 &QPF16 = RETURN
 IF (&QPF17 = ' ')
 &QPF17 = RFIND
 IF (&QPF18 = ' ')
 &QPF18 = RCHANGE
 IF (&QPF19 = ' ')
 &QPF19 = UP
 IF (&QPF20 = ' ')
 &QPF20 = DOWN
 IF (&QPF21 = ' ')
 &QPF21 = SWAP
 IF (&QPF22 = ' ')
 &QPF22 = LEFT
 IF (&QPF23 = ' ')
 &QPF23 = RIGHT
 IF (&QPF24 = ' ')
 &QPF24 = CURSOR
 IF (.MSG ^= ' ')
 .RESP = ENTER
)END
```

---

Figure 30. The PF Keys 13-24 Panel Definition (XYZABC40) (Part 2 of 2)

---

## Allocating a Data Set with LISTDSI Information - The EXPAND CLIST

The EXPAND CLIST, shown in “Allocating a Data Set with LISTDSI Information - The EXPAND CLIST”, reallocates a data set with more space to prevent the data set from running out of space.

## Allocating Data Set with LISTDSI Information - EXPAND CLIST

The EXPAND CLIST uses the LISTDSI statement to retrieve information about a base data set's allocation. The information is stored in CLIST variables. The CLIST then uses the information as input to a subprocedure. The subprocedure issues the TSO/E ALLOCATE command to create a new data set using the same attributes as the base data set, but doubling the primary space.

For more information about the CLIST variables set by LISTDSI, see "LISTDSI Statement" on page 162.

---

```

/*****
/* PROCEDURE: EXPAND
/*
/* INPUT: BASEDS - NAME OF DATA SET WITH THE ALLOCATION
/* ATTRIBUTES YOU WANT THE NEW DATA SET
/* TO HAVE.
/* NEWDS - NAME OF NEW DATA SET TO BE ALLOCATED.
/*
/* OUTPUT: NEW DATA SET ALLOCATED WITH THE SAME ATTRIBUTES AS
/* THE BASE DATA SET BUT WITH A PRIMARY ALLOCATION
/* TWICE THE SIZE OF THE BASE DATA SET.
/*
/* DESCRIPTION: ISSUE BUILT-IN FUNCTION &SYSDSN TO ENSURE THE BASE
/* DATA SET EXISTS. ISSUE LISTDSI STATEMENT TO SET
/* CLIST VARIABLES WITH ATTRIBUTES OF THE BASE DATA
/* SET. DOUBLE THE CONTENTS OF THE PRIMARY SPACE
/* VARIABLE, THEN USE THE VARIABLES AS INPUT TO
/* THE ALLOCATE COMMAND TO ALLOCATE A NEW DATA SET.
/*****

PROC 2 BASEDS NEWDS
IF &SYSDSN(&BASEDS) = OK THEN +
DO /* If the base data set exists */
LISTDSI &BASEDS /* Issue LISTDSI statement */
NGLOBAL &SYSPRIMARY,&SYSSECONDS /* Make LISTDSI variables avail- */
SET &RC = &LASTCC /* able to subprocedures */
IF &RC = 0 THEN +
SYSCALL ALC &BASEDS &NEWDS /* Call subprocedure ALC */
ELSE +
DO /* If LISTDSI failed */
WRITE &SYMSGLVL1 /* First-level message */
WRITE &SYMSGLVL2 /* Second-level message */
WRITE RETURN CODE = &RC /* Return code */
WRITE REASON CODE = &SYSREASON /* LISTDSI reason code */
END
END
ELSE +
WRITE DATA SET &BASEDS NOT FOUND
ALC: PROC 2 BASE NEW /* Subprocedure ALC */
SET NEWPRIMARY = 2 * &SYSPRIMARY /* Compute new primary space */
ALLOCATE DA(&NEW) NEW SPACE(&NEWPRIMARY,&SYSSECONDS) +
LIKE(&BASE) CATALOG /* Allocate the new data set */
WRITE DATA SET &NEW HAS BEEN ALLOCATED
END

```

---

Figure 31. The EXPAND CLIST

## Allocating Data Set with LISTDSI Information - EXPAND CLIST



---

## Chapter 13. Reference

|                                                  |     |
|--------------------------------------------------|-----|
| How to Read the CLIST Statement Syntax . . . . . | 149 |
| ATTN Statement . . . . .                         | 152 |
| CLOSEFILE Statement . . . . .                    | 153 |
| CONTROL Statement . . . . .                      | 154 |
| DATA-ENDDDATA Sequence . . . . .                 | 156 |
| DATA PROMPT-ENDDDATA Sequence . . . . .          | 156 |
| DO Statement . . . . .                           | 156 |
| END Statement . . . . .                          | 158 |
| ERROR Statement . . . . .                        | 158 |
| EXIT Statement . . . . .                         | 159 |
| GETFILE Statement . . . . .                      | 160 |
| GLOBAL Statement . . . . .                       | 160 |
| GOTO Statement . . . . .                         | 161 |
| IF-THEN-ELSE Sequence . . . . .                  | 162 |
| LISTDSI Statement . . . . .                      | 162 |
| CLIST Variables Set by LISTDSI . . . . .         | 165 |
| Return Codes . . . . .                           | 168 |
| Reason Codes . . . . .                           | 168 |
| NGLOBAL Statement . . . . .                      | 170 |
| OPENFILE Statement . . . . .                     | 170 |
| PROC Statement . . . . .                         | 171 |
| PUTFILE Statement . . . . .                      | 172 |
| READ Statement . . . . .                         | 173 |
| READDVAL Statement . . . . .                     | 173 |
| RETURN Statement . . . . .                       | 173 |
| SELECT Statement . . . . .                       | 174 |
| Simple SELECT . . . . .                          | 174 |
| Compound SELECT . . . . .                        | 175 |
| SET Statement . . . . .                          | 176 |
| SYSCALL Statement . . . . .                      | 176 |
| SYSREF Statement . . . . .                       | 177 |
| TERMIN and TERMINING Statement . . . . .         | 178 |
| WRITE and WRITENR Statements . . . . .           | 179 |
| END Command . . . . .                            | 180 |
| EXEC Command . . . . .                           | 180 |

This chapter describes the syntax of the CLIST statements. For information about the two TSO/E commands—EXEC and END—that you use to start and end CLIST execution, see *z/OS TSO/E Command Reference*.

---

### How to Read the CLIST Statement Syntax

Throughout this chapter, syntax is described using the structure defined below.

Read the syntax diagrams from left to right, from top to bottom, following the path of the line.

Double arrows indicate the beginning and ending of a statement.

▶▶—STATEMENT—◀◀

## How to Read CLIST Statement Syntax

If a statement syntax requires more than one line to be shown, single arrows indicate their continuation.



Required items appear on the horizontal line (the main path).



Optional items appear below the main path.



If you can choose from two or more items, they are stacked vertically.

- If you *must* choose one of the items, an item of the stack appears on the main path.



- If choosing one of the items is optional, the entire stack appears below the main path.



An arrow returning to the left above the main line indicates an item that can be repeated.



A repeat arrow above a stack indicates that you can make more than one choice from the stacked items, or repeat a single choice.

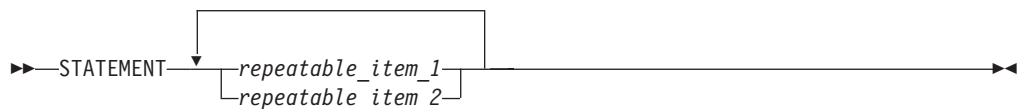

Default values appear above the main path. For example, if you choose neither *choice\_2* nor *choice\_3*, *choice\_1* is assumed. (Defaults *can* be coded for clarity reasons.)

## How to Read CLIST Statement Syntax



If a syntax diagram becomes too large or too complex to be printed or shown, fragments of it are shown below the main diagram as details.

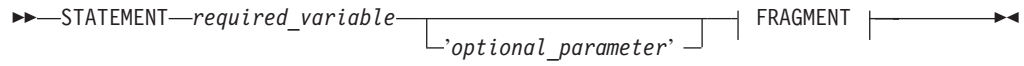

### FRAGMENT:

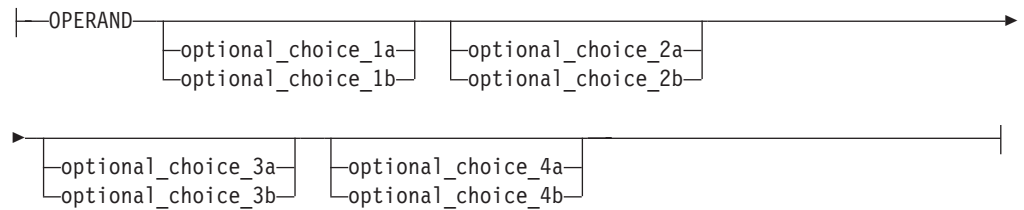

The previous syntax diagram is equivalent to the following diagram:

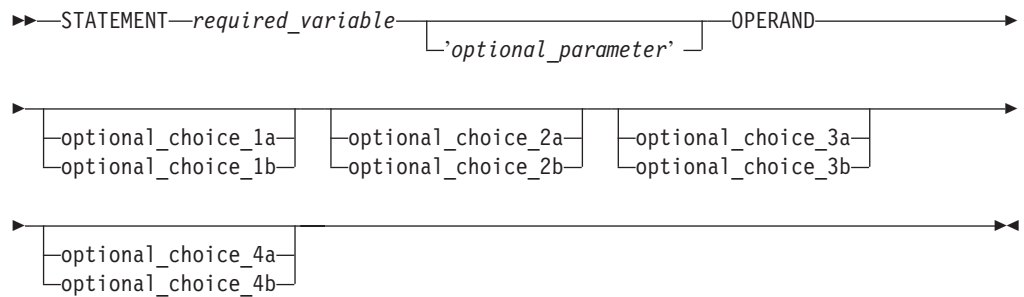

## How to Read CLIST Statement Syntax

In a CLIST statement, use uppercase letters, numbers, and the set of symbols listed below exactly as shown in the syntax.

|                                   |     |
|-----------------------------------|-----|
| <b>apostrophe or single quote</b> | '   |
| <b>asterisk</b>                   | *   |
| <b>comma</b>                      | ,   |
| <b>equal sign</b>                 | =   |
| <b>parentheses</b>                | ( ) |
| <b>period</b>                     | .   |
| <b>ampersand</b>                  | &   |
| <b>percent</b>                    | %   |
| <b>colon</b>                      | :   |

Lowercase italic letters and symbols appearing in the syntax represent variable information for which you substitute specific information in the statement. For example, if *name* appears in the syntax, substitute a specific value (for example, ALPHA) for the variable when you enter the statement.

Hyphens join lowercase words and symbols to form a single variable. For example, if *member-name* appears in the syntax, substitute a specific value (for example, BETA) for the variable in the statement.

Alphameric characters: unless otherwise indicated, an alphameric character is one of the following:

|                    |         |
|--------------------|---------|
| <b>Alphabetic:</b> | A-Z     |
| <b>Numeric:</b>    | 0-9     |
| <b>Special:</b>    | \$ # @. |

CLIST statements may be prefixed with a label consisting of 1-31 alphameric characters, beginning with an alphabetic character. The label may appear on a separate line. A colon must immediately follow the label name. For example,

```
label: +
IF A= ...
```

---

## ATTN Statement

Use the ATTN statement to define a routine that TSO/E executes when the user causes an attention interrupt. The attention interrupt halts execution of a CLIST so that the user can terminate or alter its processing.



*label*

A name the CLIST can reference in a GOTO statement to branch to this ATTN statement. *label* is one-to-31 alphameric characters, beginning with an alphabetic character.

**OFF**

Any previous attention action is nullified. Do not use ATTN OFF within an attention routine.

*action*

specifies either:

1. One TSO/E command, commonly an EXEC command that invokes an attention processing CLIST, or a null (blank) line. An attention processing CLIST can execute multiple TSO/E commands, while the action can execute only one.
2. A DO-END sequence constituting an attention exit routine. This routine can contain CLIST statements, including the RETURN statement or EXIT statement, and one TSO/E command, or a null line.

If a null line is executed, TSO/E ignores the attention and execution continues at the point where the interruption occurred.

If an EXIT statement is executed, the attention is ignored and the CLIST is terminated.

If a TSO/E command is executed, control is given to the command.

When a TSO/E command, an EXIT statement, or a null line is executed, TSO/E ignores all other.

If the attention routine does anything other than terminate the CLIST, use the MAIN operand of the CONTROL statement to protect the CLIST from being flushed from the input stack when an attention interrupt occurs. For more information, see "CONTROL Statement" on page 154.

---

## CLOSEFILE Statement

Use the CLOSEFILE statement to close a QSAM file that has been previously opened by an OPENFILE statement. Only one file can be closed with each CLOSEFILE statement.

**Note:** The CLOSEFILE statement must be issued in the same CLIST as the corresponding OPENFILE statement.

```

▶▶ [label:] CLOSEFILE [file_name | &symbolic_variable_name] ▶▶

```

*label*

A name the CLIST can reference in a GOTO statement to branch to this CLOSEFILE statement. *label* is one-to-31 alphameric characters, beginning with an alphabetic character.

*file\_name* | *symbolic\_variable\_name*

*file\_name*

is the file name (ddname) assigned to the file (data set) when it was allocated in the current session.

*symbolic\_variable\_name*

is the symbolic variable to which you assigned *file\_name*.

## CONTROL Statement

Use the CONTROL statement to define processing options for a CLIST. The options are in effect from the time CONTROL executes until either the CLIST terminates or it issues another CONTROL statement.

You can also set CONTROL options on or off in the following variables:

|                        |                                         |
|------------------------|-----------------------------------------|
| <b>&amp;SYSPROMPT</b>  | ON equals PROMPT, OFF equals NOPROMPT   |
| <b>&amp;SYSSYMLIST</b> | ON equals SYMLIST, OFF equals NOSYMLIST |
| <b>&amp;SYSCONLIST</b> | ON equals CONLIST, OFF equals NOCONLIST |
| <b>&amp;SYSLIST</b>    | ON equals LIST, OFF equals NOLIST       |
| <b>&amp;SYSASIS</b>    | ON equals ASIS, OFF equals CAPS         |
| <b>&amp;SYSMSG</b>     | ON equals MSG, OFF equals NOMSG         |
| <b>&amp;SYNFLUSH</b>   | ON equals FLUSH, OFF equals NOFLUSH.    |

CLISTs that do not issue CONTROL statements or one of the above variables execute with the following options: NOPROMPT, NOSYMLIST, NOLIST, NOCONLIST, CAPS, MSG, and FLUSH. The user can set PROMPT and LIST by entering them as keywords on the EXEC command or subcommand issued to invoke the CLIST.

CONTROL has no default operands. If you enter CONTROL with no operands, the system uses options already defined by system default, the EXEC command, or a previous CONTROL statement. In addition, when there are no operands specified, the system displays those options currently in effect.

**Note:** CONTROL operands cannot be entered as symbolic variables.

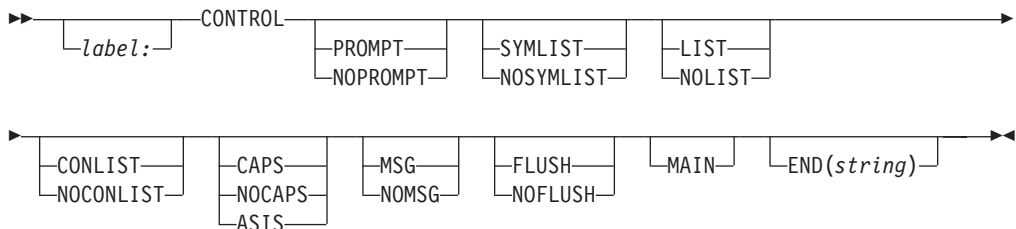

### *label*

A name the CLIST can reference in a GOTO statement to branch to this CONTROL statement. *label* is one-to-31 alphanumeric characters, beginning with an alphabetic character.

### PROMPT | NOPROMPT

#### PROMPT

TSO/E commands in the CLIST may prompt the terminal for input. (The PROMPT operand on the PROFILE command must also be in effect.)

#### NOPROMPT

TSO/E commands in the CLIST may not prompt the terminal for input.

### SYMLIST | NOSYMLIST

#### SYMLIST

Each executable statement is displayed at the terminal before it is scanned

for symbolic substitution. Executable statements include commands, subcommands, and CLIST statements.

### **NOSYMLIST**

Executable statements are not displayed at the terminal before symbolic substitution.

### **LIST | NOLIST**

#### **LIST**

Commands and subcommands are displayed at the terminal after symbolic substitution but before execution.

#### **NOLIST**

Commands and subcommands are not displayed at the terminal.

### **CONLIST | NOCONLIST**

#### **CONLIST**

CLIST statements are displayed at the terminal after symbolic substitution but before execution.

#### **NOCONLIST**

CLIST statements are not displayed at the terminal after symbolic substitution.

### **CAPS | NOCAPS | ASIS**

#### **CAPS**

Character strings are converted to uppercase letters before being processed.

#### **NOCAPS or ASIS**

Character strings are not converted to uppercase before being processed.

### **MSG | NOMSG**

#### **MSG**

Informational messages from commands and statements in the CLIST are displayed at the terminal.

#### **NOMSG**

Informational messages from commands and statements in the CLIST are not displayed at the terminal.

### **FLUSH | NOFLUSH**

#### **FLUSH**

The system can erase (flush) the queue of nested CLISTs called the input stack unless NOFLUSH or MAIN is encountered. The system normally flushes the stack when an execution error occurs.

#### **NOFLUSH**

The system cannot flush the CLIST when an error occurs.

**Note:** To protect a CLIST from being flushed, the CLIST must contain an error routine.

### **MAIN**

This is the main CLIST in your TSO/E environment and cannot be deleted by a stack flush request from the system. When MAIN is specified, the NOFLUSH condition is assumed for this CLIST, regardless of whether FLUSH was in effect. This operand is required for CLISTs containing attention routines that do anything other than terminate the CLIST.

## CONTROL Statement

### END(*string*)

A character string recognized by the CLIST as a replacement for an END statement that concludes a DO or SELECT statement, or a subprocedure. *string* is 1-4 alphameric characters, beginning with an alphabetic character.

---

## DATA-ENDDATA Sequence

Use the DATA-ENDDATA sequence when you do not want a command or subcommand to be interpreted as a CLIST statement. The CLIST views the group of commands and subcommands in the DATA-ENDDATA sequence as data to be ignored and passed to TSO/E for execution.

Do not include CLIST statements in a DATA-ENDDATA sequence because TSO/E attempts to execute them as commands or subcommands.

Symbolic substitution is performed before execution of the group.

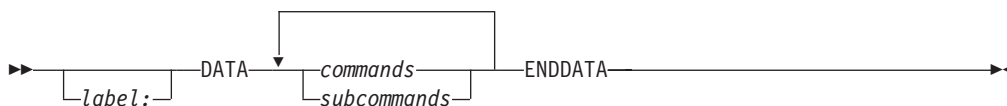

### *label*

A name the CLIST can reference in a GOTO statement to branch to this DATA-ENDDATA sequence. *label* is one-to-31 alphameric characters, beginning with an alphabetic character.

### *commands* | *subcommands*

The data to be ignored and passed to TSO/E for execution.

---

## DATA PROMPT-ENDDATA Sequence

Use the DATA PROMPT-ENDDATA sequence to designate responses to prompts by TSO/E commands or subcommands. An error condition (error code 968) occurs unless the sequence is immediately preceded by a command or subcommand issuing a prompt.

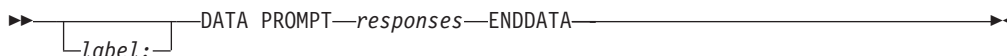

**Note:** When using the DATA PROMPT-ENDDATA sequence, the following rules apply:

- The CLIST must allow prompting.
- Symbolic substitution is performed before a reply is sent.

---

## DO Statement

Use the DO statement to execute sequences of commands, subcommands, and statements (DO-sequences). You can use the DO statement to execute DO-sequences once, repeatedly, and when certain conditions are true.

To execute a DO-sequence *once*, include only the DO and END statements.

To execute a DO-sequence *repeatedly*, include a variable with a starting value, a TO value, and, optionally, a BY value.



## DO Statement

To execute a DO-sequence *conditionally*, include a WHILE or UNTIL clause. The WHILE clause contains a leading decision and executes while a comparative expression is true, and the UNTIL clause contains a trailing decision and executes until a comparative expression is true.

To execute a DO-sequence repeatedly *and* conditionally (compound DO), the WHILE and/or UNTIL clauses must follow the from, TO, and optional BY clauses.

The DO statement indicates the beginning of a DO-sequence. The END statement concludes the DO-sequence. If you want to use the TSO/E END command in a DO-sequence, you must redefine the END statement, using the END operand of the CONTROL statement.

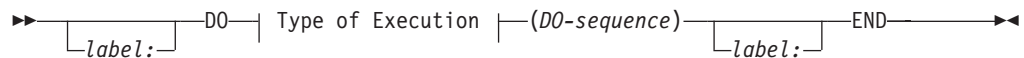

### Type of Execution

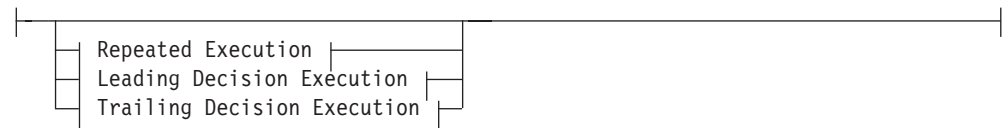

### Repeated Execution

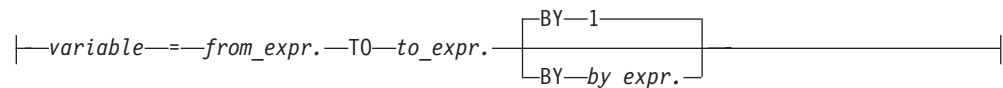

### Leading Decision Execution



### Trailing Decision Execution



#### *label*

A name the CLIST can reference in a GOTO statement to branch to this DO statement. *label* is one-to-31 alphameric characters, beginning with an alphabetic character.

#### *variable*

A symbolic variable that controls execution of the DO-sequence. With each execution, the variable value increases or decreases by a certain amount. When the value passes a certain limit, the CLIST stops executing the DO-sequence and executes the next instruction after the END statement.

#### *from\_expression*

A decimal integer, or an expression that evaluates to a decimal integer, forming the initial value of the DO variable.

## DO Statement

### *to\_expression*

A decimal integer, or an expression that evaluates to a decimal integer, forming the terminal value of the DO variable.

### *by\_expression*

A decimal integer, or an expression that evaluates to a decimal integer, by which the DO variable increases or decreases each time the DO-sequence executes.

### *condition*

A comparative expression or a sequence of comparative expressions sequenced by logical operators. The expression or expressions can include character data, including characters of the double-byte character set.

In the absence of a BY clause, the value of the DO variable increases by 1 with each execution of the DO sequence.

If the *by-expression* evaluates to a negative number or consists of a number beginning with a minus sign, the DO variable decreases by that amount.

If the statements in a DO-sequence modify a DO variable, the CLIST uses the new value in determining whether to repeat the DO-sequence.

DO-sequences can contain nested DO statements.

---

## END Statement

Use the END statement to mark the end of a DO-sequence, a SELECT statement, or a subprocedure. The END statement must appear on a line by itself following the DO-sequence, SELECT statement, or subprocedure.

▶—END—▶

The END statement is distinct from the TSO/E END command. If you use both the END statement and END command in a CLIST, you must distinguish them by redefining the END statement. Using the CONTROL statement, you can redefine the END statement as follows:

```
CONTROL END(string)
```

where *string* is 1-4 alphanumeric characters, beginning with an alphabetic character. You then use the string in place of END statements in the CLIST.

---

## ERROR Statement

Use the ERROR statement to set up an environment that checks for non-zero return codes from commands, subcommands, and CLIST statements in the currently executing CLIST. When an error code is detected, processing continues at the ERROR routine active for the command, subcommand, or CLIST statement that registered the error. If an ERROR routine is not active, the CLIST either terminates or continues, depending on the severity of the error.

The error exit must be protected from being flushed from the input stack by the system. Stack flushing makes the error return codes unavailable. Use the MAIN or NOFLUSH operands of the CONTROL statement to prevent stack flushing.

## ERROR Statement

When ERROR is entered with no operands, the CLIST displays the command, subcommand, or statement in the CLIST that ended in error. No explanatory CLIST ERROR messages are displayed. &LASTCC is reset to 0 and the CLIST continues with the next sequential statement or command.

If the LIST option was requested for the CLIST, the null ERROR statement is ignored.

The ERROR statement must precede any statements that might cause a branch to it.



### *label*

A name the CLIST can reference in a GOTO statement to branch to this ERROR statement. *label* is one-to-31 alphameric characters, beginning with an alphabetic character.

### **OFF** | *action*

#### **OFF**

Any action previously set up by an ERROR statement is nullified.

#### *action*

Any executable statement, commonly a DO-sequence constituting a routine. The action may execute TSO/E commands, subcommands, and CLIST statements.

**Note:** Coding ERROR OFF within the DO-sequence routine itself prevents the routine from returning control to the CLIST.

---

## EXIT Statement

Use the EXIT statement to return control to the program that called the currently executing CLIST. The return code associated with this exit can be specified by the user or allowed to default to 0.

A CLIST that is called by another CLIST is said to be nested. Multiple levels of nesting are allowed. The structure of the nesting is called the hierarchy. You go “up” in the hierarchy when control passes back to the calling CLIST. TSO/E itself is at the top of the hierarchy.

Entering EXIT causes control to go up one level. When EXIT is entered with the QUIT operand, the system attempts to pass control upward to the first CLIST encountered that has MAIN or NOFLUSH in effect (see “CONTROL Statement” on page 154). If no such CLIST is found, control passes to TSO/E, which flushes all CLISTs from the input stack and passes control to the terminal.

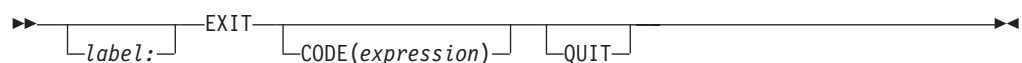

## EXIT Statement

*label*

A name the CLIST can reference in a GOTO statement to branch to this EXIT statement. *label* is one-to-31 alphameric characters, beginning with an alphabetic character.

**CODE** (*expression*)

A CLIST-defined return code. *expression* must be a positive integer, zero, or an expression that evaluates to a decimal integer. When CODE is not specified, the system uses 0 as the default return code.

**QUIT**

Control is passed up the nested hierarchy until either a CLIST is found with the MAIN or NOFLUSH option active or TSO/E receives control.

---

## GETFILE Statement

Use the GETFILE statement to read a record from a QSAM file opened by the OPENFILE statement. One record is obtained by each execution of GETFILE.

After GETFILE executes, the file name variable contains the record obtained. If you use GETFILE to read data from the terminal, the data is translated to uppercase.

**Note:** The GETFILE statement must be issued in the same CLIST as the corresponding OPENFILE statement.

► `┌` `label:` `└` GETFILE `file_name` `►`

*label*

A name the CLIST can reference in a GOTO statement to branch to this GETFILE statement. *label* is one-to-31 alphameric characters, beginning with an alphabetic character.

*file\_name*

The file name (ddname) assigned to the file (data set) when it was allocated in the current session. Do not specify a symbolic variable containing the file name.

---

## GLOBAL Statement

Use the GLOBAL statement to share values between nested CLISTs. In the hierarchy of nested CLISTs, the highest-level CLIST must contain a GLOBAL statement with the maximum number of variables used throughout the nested chain. Lower-level CLISTs must include a GLOBAL statement if they intend to refer to the global variables defined in the highest-level CLIST.

**Note:** The GLOBAL statement cannot be used to give a REXX exec access to a CLIST's global variables. CLIST variables cannot be accessed by REXX execs.

The global variables are positional, and the order is defined by the GLOBAL statement in the highest-level CLIST. All lower-level CLISTs that reference this same set of variables must follow this order to reference the same values. The variable names may be unique to the lower-level CLISTs. This means that the Nth name on any level GLOBAL statement refers to the same value, even though the symbolic name at each level may be different. For example, if a nested CLIST references the fifth global variable, then it must define five global variables. If it references the second global variable, then it needs to define only two global variables.

## GLOBAL Statement

Multiple GLOBAL statements are cumulative. For example, if a CLIST has a GLOBAL statement that defines three variables followed by another GLOBAL statement that defines two variables, then five variables have been defined. The second GLOBAL statement defines the fourth and fifth variables.

The GLOBAL statement must precede any statement that uses or defines its variables.

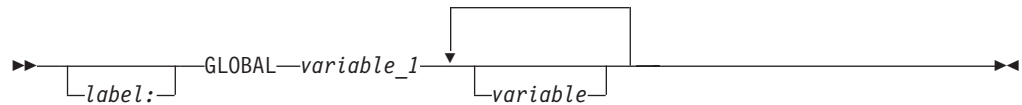

### *label*

A name the CLIST can reference in a GOTO statement to branch to this GLOBAL statement. *label* is one-to-31 alphameric characters, beginning with an alphabetic character.

### *variable\_1 | variable*

A symbolic variable name for this CLIST. The name refers to a variable that is either being created by this GLOBAL statement or that was created by a GLOBAL statement in the highest-level CLIST.

---

## GOTO Statement

Use the GOTO statement to cause an unconditional branch within a CLIST. Branching to another CLIST is not allowed.

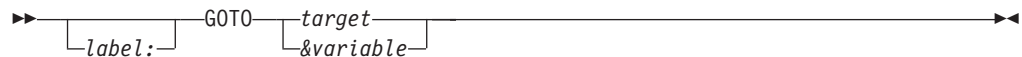

### *label*

A name the CLIST can reference in a GOTO statement to branch to this GOTO statement. *label* is one-to-31 alphameric characters, beginning with an alphabetic character.

### *target | variable*

#### *target*

A label on a statement or command.

#### *variable*

A symbolic variable that contains a valid label.

GOTO statements cannot branch:

- To another CLIST
- To a subprocedure's PROC statement
- From one subprocedure to another
- From a subprocedure to the CLIST's main procedure

## IF-THEN-ELSE Sequence

---

### IF-THEN-ELSE Sequence

Use the IF-THEN-ELSE sequence to define a condition, test the truth of that condition, and initiate an action based on the test results. Do not code THEN and ELSE on the same logical line.

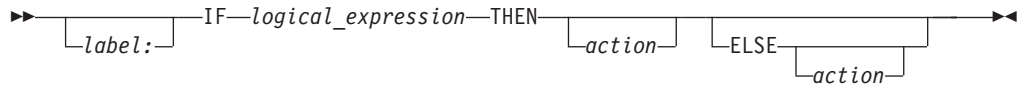

#### *label*

A name the CLIST can reference in a GOTO statement to branch to this IF-THEN-ELSE sequence. *label* is one-to-31 alphanumeric characters, beginning with an alphabetic character.

#### *logical\_expression*

A comparative expression or a sequence of comparative expressions sequenced by logical operators. The expression or expressions can include character data, including characters of the double-byte character set.

#### *action*

An executable command, subcommand, or CLIST statements. (Enclose an action consisting of more than one statement in a DO-sequence.) The THEN action is invoked if the logical expression is true. The ELSE action is invoked if the logical expression is false. If a null THEN or null ELSE statement is executed, control passes to the next sequential statement after the IF-THEN-ELSE sequence.

The action must be on the same line as a THEN or ELSE clause, or be joined to the line by a continuation character. For example, the following are correct:

```
IF &FOOTPRINT = 0 THEN SET ECODE = 4
```

```
IF &FOOTPRINT = 0 THEN +
 SET ECODE = 4
```

```
IF &FOOTPRINT = 0 THEN +
 DO
 SET ECODE = 4
 ⋮
 END
```

---

## LISTDSI Statement

Use the LISTDSI statement to obtain information about a data set that is available on DASD. The LISTDSI statement can retrieve information about a data set's allocation, protection, and directory, and store the information in CLIST variables.

The LISTDSI statement does not support data that is on tape. The LISTDSI statement supports generation data group (GDG) data sets, but does not support relative GDG names. LISTDSI does not support hierarchical file systems (HFS) data sets. Unpredictable results may occur.

The CLIST can use the LISTDSI information to determine whether the data set is the right size or has the right organization or format for a given task. It can also use the LISTDSI information as input to the ALLOCATE command, to create a new data set using some attributes from the old data set while modifying others.

## LISTDSI Statement

If you use LISTDSI to retrieve information about a VSAM data set, the CLIST stores only the volume serial ID (in variable &SYSVOLUME), the generic device type (in variable &SYSUNIT), and the data set organization (in variable &SYSDSORG). The CLIST sets all other LISTDSI variables to question marks.

If you use LISTDSI to retrieve information about a multiple volume data set, the CLIST stores information for the first volume only. Similarly, if you specify a file name or the PREALLOC parameter and you have other data sets allocated to the same file name, then the system might not retrieve information for the data set you wanted.

When you use LISTDSI to obtain information about a FILE, LISTDSI will only return information about the first data set in the FILE, if the file consists of a concatenation of more than one data set. Likewise, if the FILE points to a multi-volume data set, LISTDSI can only return information about the first volume, and will not be able to detect that the data is multi-volume.

If the data set is SMS managed and is capable of expanding to multiple volumes, but has not yet done so, it is considered a single volume data set by LISTDSI until it has expanded to the second volume. In any case, LISTDSI will only retrieve information for the first volume referenced by the request.

**Note:** LISTDSI considers file names in the form SYSnnnnn as system-generated file names. If LISTDSI is used to obtain information about a data set that was pre-allocated multiple times using a file name of the form SYSnnnnn, an existing file may be unintentionally freed.

To suppress TSO/E messages issued by the LISTDSI statement, use the CONTROL NOMSG statement. For information about the CONTROL statement, see “CONTROL Statement” on page 154.

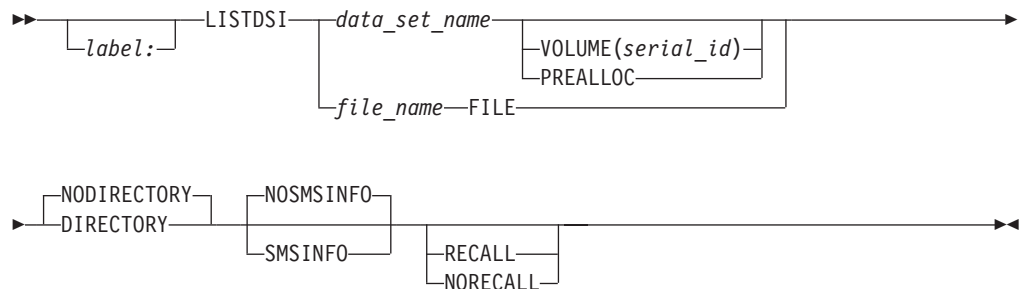

### *label*

A name the CLIST can reference in a GOTO statement to branch to this LISTDSI statement. *label* is one-to-31 alphanumeric characters, beginning with an alphabetic character.

### *data\_set\_name* | *file\_name*

#### *data\_set\_name*

The name of the data set about which you want to retrieve information.

#### *file\_name*

The name of an allocated file (ddname) about which you want to retrieve information.

### **VOLUME(*serial\_id*) | PREALLOC**

## LISTDSI Statement

### **VOLUME**(*serial\_id*)

specifies the serial number of the volume where the data set is located.

### **PREALLOC**

specifies that the location of the specified data set is determined by allocating the data set, rather than through a catalog search. PREALLOC allows data sets that have been previously allocated to be located without searching a catalog and allows unmounted volumes to be mounted.

If you do not specify either VOLUME or PREALLOC, the system locates the data set through catalog search.

If you specify a *file\_name*, LISTDSI ignores the VOLUME and PREALLOC parameters.

### **FILE**

specifies that you provided a *file\_name* instead of a *data\_set\_name*. If you do not specify FILE, LISTDSI assumes that you provided a data set name.

### **DIRECTORY | NODIRECTORY**

#### **DIRECTORY**

indicates that you want directory information for a partitioned data set.

#### **NODIRECTORY**

indicates that you do not want directory information for a partitioned data set. If you do not require directory information, NODIRECTORY can significantly speed up processing. NODIRECTORY is the default.

### **SMSINFO | NOSMSINFO**

indicates whether you want SMS information about an SMS-managed data set, like the type of data set, the used space, the data -, storage -, and management class names. See also Table 11 on page 165.

#### **SMSINFO**

indicates that you want SMS information about *data\_set\_name* or *file\_name*. Neither *data\_set\_name* nor *file\_name* may refer to a VSAM index or a data component.

If the specified data set is not managed by SMS, LISTDSI continues, but no SMS information is provided in the appropriate CLIST variables.

Specify SMSINFO only if you want SMS information about a data set. NOSMSINFO (the default) significantly reduces the execution time of the LISTDSI statement.

#### **NOSMSINFO**

indicates that you do not want SMS information about the specified data set. NOSMSINFO is the default.

### **RECALL | NORECALL**

#### **RECALL**

indicates that you want to recall a data set migrated by HSM. The system recalls the data set regardless of its level of migration or the type of device it has been migrated to.

#### **NORECALL**

indicates that you do not want to recall a data set. If the data set has been migrated, the system displays an error message.



## LISTDSI Statement

If you do not specify either RECALL or NORECALL, the system recalls the data set only if it has been migrated to a direct access storage device (DASD).

The LISTDSI function issues message IKJ56709I if a syntactically incorrect data set name is passed to the function. To prevent this message from being displayed, use CONTROL NOMSG.

```
PROC 0
SET DSNAME = ABCDEFGHIJ.XYZ /* Syntactically invalid name,
 /* because a qualifier is longer
 /* than 8 characters
CONTROL NOMSG /* Set OFF to suppress any LISTDSI
 /* TS0/E messages
LISTDSI &DSNAME /* Obtain data set information
WRITE Return code from LISTDSI is ==> &LASTCC
EXIT CODE(0)
```

## CLIST Variables Set by LISTDSI

Table 11 describes the contents of the CLIST variables set by LISTDSI. For VSAM data sets, only the variables &SYSVOLUME, &SYSUNIT, and &SYSDSORG are accurate; all other variables are set to question marks.

Table 11. Variables Set by LISTDSI

| Variable   | Contents                                                                                                                                                                                                                                                                                                                                                                                   |
|------------|--------------------------------------------------------------------------------------------------------------------------------------------------------------------------------------------------------------------------------------------------------------------------------------------------------------------------------------------------------------------------------------------|
| &SYSDSNAME | Data set name                                                                                                                                                                                                                                                                                                                                                                              |
| &SYSVOLUME | Volume serial ID                                                                                                                                                                                                                                                                                                                                                                           |
| &SYSUNIT   | Generic device type on which volume resides, for example, "3390".                                                                                                                                                                                                                                                                                                                          |
| &SYSDSORG  | Data set organization:<br><b>PS</b> Physical sequential<br><b>PSU</b> Physical sequential unmovable<br><b>DA</b> Direct organization<br><b>DAU</b> Direct organization unmovable<br><b>IS</b> Indexed sequential<br><b>ISU</b> Indexed sequential unmovable<br><b>PO</b> Partitioned organization<br><b>POU</b> Partitioned organization unmovable<br><b>VS</b> VSAM<br><b>???</b> Unknown |

## LISTDSI Statement

Table 11. Variables Set by LISTDSI (continued)

| Variable      | Contents                                                                                                                                                                                                                                                                                                                                                                                                                                                                                                                                                         |
|---------------|------------------------------------------------------------------------------------------------------------------------------------------------------------------------------------------------------------------------------------------------------------------------------------------------------------------------------------------------------------------------------------------------------------------------------------------------------------------------------------------------------------------------------------------------------------------|
| &SYSRECFM     | Record format; 1- to 6-character combination of the following:<br><b>U</b> Records of undefined length<br><b>F</b> Records of fixed length<br><b>V</b> Records of variable length<br><b>T</b> Records written with the track overflow feature of the device (3375, 3380, and 3390 do not support track overflow)<br><b>B</b> Records blocked<br><b>S</b> Records written as standard or spanned variable-length blocks<br><b>A</b> Records contain ASCII control characters<br><b>M</b> Records contain machine code control characters<br><b>??????</b> Unknown |
| &SYSRECL      | Logical record length                                                                                                                                                                                                                                                                                                                                                                                                                                                                                                                                            |
| &SYSBLKSIZE   | Block size                                                                                                                                                                                                                                                                                                                                                                                                                                                                                                                                                       |
| &SYSKEYLEN    | Key length                                                                                                                                                                                                                                                                                                                                                                                                                                                                                                                                                       |
| &SYSALLOC     | Allocation, in space units                                                                                                                                                                                                                                                                                                                                                                                                                                                                                                                                       |
| &SYSUSED      | Allocation used, in space units. For a partitioned data set extended (PDSE) "N/A" will be returned; see the description of the &SYSUSEDPAGES for used space of a PDSE.                                                                                                                                                                                                                                                                                                                                                                                           |
| &SYSUSEDPAGES | The used space of a partitioned data set extended (PDSE) in 4K pages.                                                                                                                                                                                                                                                                                                                                                                                                                                                                                            |
| &SYSPRIMARY   | Primary allocation in space units                                                                                                                                                                                                                                                                                                                                                                                                                                                                                                                                |
| &SYSSECONDS   | Secondary allocation in space units                                                                                                                                                                                                                                                                                                                                                                                                                                                                                                                              |
| &SYSUNITS     | Space units:<br><b>CYLINDER</b> Space units in cylinders<br><b>TRACK</b> Space units in tracks<br><b>BLOCK</b> Space units in blocks<br><b>????????</b> Space units are unknown                                                                                                                                                                                                                                                                                                                                                                                  |
| &SYSEXTENTS   | Number of extents allocated                                                                                                                                                                                                                                                                                                                                                                                                                                                                                                                                      |
| &SYSCREATE    | Creation date in Year/day format, for example: 1985/102.                                                                                                                                                                                                                                                                                                                                                                                                                                                                                                         |
| &SYSREFDATE   | Last referenced date in Year/day format, for example: 1995/107. (Specifying DIRECTORY causes the date to be updated)                                                                                                                                                                                                                                                                                                                                                                                                                                             |
| &SYSEXDATE    | Expiration date in Year/day format, for example: 1995/365.                                                                                                                                                                                                                                                                                                                                                                                                                                                                                                       |
| &SYSPASSWORD  | Password indication:<br><b>NONE</b> No password protection<br><b>READ</b> Password required to read<br><b>WRITE</b> Password required to write                                                                                                                                                                                                                                                                                                                                                                                                                   |

Table 11. Variables Set by LISTDSI (continued)

| Variable    | Contents                                                                                                                                                                                                                                                                                                 |
|-------------|----------------------------------------------------------------------------------------------------------------------------------------------------------------------------------------------------------------------------------------------------------------------------------------------------------|
| &SYSRACFA   | RACF indication:<br><b>NONE</b> No RACF protection<br><b>GENERIC</b> Generic profile covers this data set<br><b>DISCRETE</b> Discrete profile covers this data set                                                                                                                                       |
| &SYSUPDATED | Change indicator:<br><b>YES</b> Data set has been updated<br><b>NO</b> Data set has not been updated                                                                                                                                                                                                     |
| &SYSTRKSCYL | Tracks per cylinder for the unit identified in the &SYSUNIT variable                                                                                                                                                                                                                                     |
| &SYSBLKSTRK | Blocks of &SYSBLKSIZE per track for the unit identified in the &SYSUNIT variable. For a PDSE, the value "N/A" is returned because a block of size &SYSBLKSIZE can 'span' a track in a PDSE. The value contained in &SYSUSEDPAGES is a more meaningful measurement of space usage for a PDSE.             |
| &SYSADIRBLK | For a partitioned data set (PDS), the number of directory blocks allocated will be returned. For a partitioned data set extended (PDSE), "NO_LIM" will be returned because there is no static allocation for its directory. A value is returned only if DIRECTORY is specified on the LISTDSI statement. |
| &SYSUDIRBLK | For a partitioned data set (PDS), the number of directory blocks used will be returned. For a partitioned data set extended (PDSE), "N/A" will be returned because it is not a static value. A value is returned only if DIRECTORY is specified on the LISTDSI statement.                                |
| &SYSMEMBERS | Number of members - returned only for partitioned data sets when DIRECTORY is specified                                                                                                                                                                                                                  |
| &LASTCC     | LISTDSI return code                                                                                                                                                                                                                                                                                      |
| &SYSREASON  | LISTDSI reason code                                                                                                                                                                                                                                                                                      |
| &SYSMSGVL1  | First-level message if an error occurred                                                                                                                                                                                                                                                                 |
| &SYSMSGVL2  | Second-level message if an error occurred                                                                                                                                                                                                                                                                |

## LISTDSI Statement

Table 11. Variables Set by LISTDSI (continued)

| Variable                                                                                                                                                                                 | Contents                                                                                                                                                                                                                                                                                                                                                                                                                                                                                                                                                                                                                                                  |
|------------------------------------------------------------------------------------------------------------------------------------------------------------------------------------------|-----------------------------------------------------------------------------------------------------------------------------------------------------------------------------------------------------------------------------------------------------------------------------------------------------------------------------------------------------------------------------------------------------------------------------------------------------------------------------------------------------------------------------------------------------------------------------------------------------------------------------------------------------------|
| &SYSDSSMS                                                                                                                                                                                | <p>Contains information about the type of a data set, provided by DFSMS/MVS.</p> <p>If the SMS DSNTYPE information could not be retrieved, the SYSDSSMS variable contains:</p> <p><b>SEQ</b> for a sequential data set</p> <p><b>PDS</b> for a partitioned data set</p> <p><b>PDSE</b> for a partitioned data set extended</p> <p>If the data set is a PDSE and the SMS DSNTYPE information could be retrieved, the SYSDSSMS variable contains:</p> <p><b>LIBRARY</b> for an empty PDSE</p> <p><b>PROGRAM_LIBRARY</b> for a partitioned data set extended program library</p> <p><b>DATA_LIBRARY</b> for a partitioned data set extended data library</p> |
| &SYSDATACLASS <sup>(1)</sup>                                                                                                                                                             | The SMS data class name - returned only if SMSINFO is specified on the LISTDSI statement and the data set is managed by SMS.                                                                                                                                                                                                                                                                                                                                                                                                                                                                                                                              |
| &SYSSTORCLASS <sup>(1)</sup>                                                                                                                                                             | The SMS storage class name - returned only if SMSINFO is specified on the LISTDSI statement and the data set is managed by SMS.                                                                                                                                                                                                                                                                                                                                                                                                                                                                                                                           |
| &SYSMGMTCLASS <sup>(1)</sup>                                                                                                                                                             | The SMS management class name - returned only if SMSINFO is specified on the LISTDSI statement and the data set is managed by SMS.                                                                                                                                                                                                                                                                                                                                                                                                                                                                                                                        |
| <b>Note:</b>                                                                                                                                                                             |                                                                                                                                                                                                                                                                                                                                                                                                                                                                                                                                                                                                                                                           |
| 1. These variables require either MVS/DFP 3.2 (or later) or DFSMS/MVS 1.1 (or later) to be active on your system. For data sets not managed by SMS these variables return a null string. |                                                                                                                                                                                                                                                                                                                                                                                                                                                                                                                                                                                                                                                           |

## Return Codes

Return codes from the LISTDSI statement appear in CLIST variable &LASTCC. Error routines do not receive control when a CLIST receives a non-zero return code from LISTDSI. Table 12 lists the LISTDSI return codes and their meanings.

Table 12. LISTDSI Return Codes

| Return Code | Meaning                                                                                                                      |
|-------------|------------------------------------------------------------------------------------------------------------------------------|
| 0           | Processing successful                                                                                                        |
| 4           | Some data set information is unavailable. All data set information other than directory information can be considered valid. |
| 16          | Processing unsuccessful. None of the CLIST variables can be considered valid.                                                |

## Reason Codes

Reason codes from the LISTDSI statement appear in CLIST variable &SYSREASON. Table 13 on page 169 lists the LISTDSI reason codes and their meanings. With each reason code the CLIST variable &SYSMSGVL2 is set to

message IKJ584nnl, where *nn* is the reason code. These messages are described in *z/OS TSO/E Messages*.

Table 13. LISTDSI Reason Codes

| Reason Code | Meaning                                                                                                                                                                |
|-------------|------------------------------------------------------------------------------------------------------------------------------------------------------------------------|
| 0           | Normal completion                                                                                                                                                      |
| 1           | Error parsing the statement.                                                                                                                                           |
| 2           | Dynamic allocation processing error (SVC 99 error).                                                                                                                    |
| 3           | The data set is a type that cannot be processed.                                                                                                                       |
| 4           | Error determining UNIT name (IEFEB4UV error).                                                                                                                          |
| 5           | Data set not cataloged (LOCATE macro error).                                                                                                                           |
| 6           | Error obtaining the data set attributes (OBTAIN macro error).                                                                                                          |
| 7           | Error finding device type (DEVTYPE macro error).                                                                                                                       |
| 8           | The data set does not reside on a direct access device.                                                                                                                |
| 9           | DFHSM migrated the data set, NORECALL prevents retrieval.                                                                                                              |
| 11          | Directory information was requested, but you lack authority to access the data set.                                                                                    |
| 12          | VSAM data sets are not supported.                                                                                                                                      |
| 13          | The data set could not be opened.                                                                                                                                      |
| 14          | Device type not found in unit control block (UCB) tables.                                                                                                              |
| 17          | System or user abend occurred.                                                                                                                                         |
| 18          | Partial data set information was obtained.                                                                                                                             |
| 19          | Data set resides on multiple volumes.                                                                                                                                  |
| 20          | Device type not found in eligible device table (EDT).                                                                                                                  |
| 21          | Catalog error trying to locate the data set.                                                                                                                           |
| 22          | Volume not mounted (OBTAIN macro error).                                                                                                                               |
| 23          | Permanent I/O error on volume (OBTAIN macro error).                                                                                                                    |
| 24          | Data set not found by OBTAIN macro.                                                                                                                                    |
| 25          | Data set migrated to non-DASD device.                                                                                                                                  |
| 26          | Data set on MSS (Mass Storage) device.                                                                                                                                 |
| 27          | No volume serial is allocated to the data set.                                                                                                                         |
| 28          | ddname must be one to eight characters.                                                                                                                                |
| 29          | Data set name or ddname must be specified.                                                                                                                             |
| 30          | Data set is not SMS-managed.                                                                                                                                           |
| 31          | ISITMGD macro returned with bad return code and reason code. Return code and reason code can be found in message IKJ58431I, which is returned in variable &SYSMSGLVL2. |
| 32          | Unable to retrieve SMS information. DFSMS/MVS has incorrect level.                                                                                                     |
| 33          | Unable to retrieve SMS information. DFSMS/MVS is not active.                                                                                                           |
| 34          | Unable to retrieve SMS information. OPEN error.                                                                                                                        |
| 35          | Unexpected error from DFSMS/MVS internal service IGWFAMS.                                                                                                              |
| 36          | Unexpected error from the SMS service module.                                                                                                                          |
| 37          | Unexpected error from DFSMS service IGGCSI00.                                                                                                                          |

## NGLOBAL Statement

---

### NGLOBAL Statement

Use the NGLOBAL statement to share values between subprocedures in a CLIST.

The NGLOBAL (named global) statement defines variables by name. When you define an NGLOBAL variable, other subprocedures in the same CLIST can refer to it by name and modify its value. Other CLISTs cannot access or modify an NGLOBAL variable.

There is no limit to the number of variables that can be defined on an NGLOBAL statement. The NGLOBAL statement must precede any statement that uses its variables.

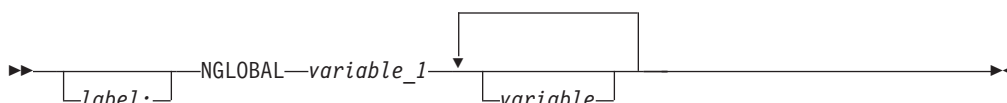

#### *label*

A name the CLIST can reference in a GOTO statement to branch to this NGLOBAL statement. *label* is one-to-31 alphanumeric characters, beginning with an alphabetic character.

#### *variable\_1* | *variable*

A symbolic variable name for this CLIST. The name refers to a variable that is being defined by this NGLOBAL statement.

**Note:** Variables named on an NGLOBAL statement cannot appear on a PROC statement.

---

### OPENFILE Statement

Use the OPENFILE statement to open a QSAM file for I/O. The file must have been allocated during the session and assigned a file name. Each execution of OPENFILE can open only one file, and files cannot be open for different members of the same PDS at the same time. The files must represent data sets with logical record lengths no greater than 32767 bytes.

**Note:** The OPENFILE statement sets any I/O variables to nulls. Always execute the OPENFILE statement before using any SET statements to create I/O records.

Complete your file I/O on a specific file before changing from command to subcommand mode and vice versa. Cross-mode file I/O is not supported and causes unpredictable abnormal terminations.

Specify NOFLUSH for a CLIST that uses file I/O. (See the CONTROL statement.) If a system action causes TSO/E to flush the input stack because you did not specify NOFLUSH, a user may have to log off the system to recover. The user will recognize the condition by receiving a message similar to "FILE NOT FREED, DATA SET IS OPEN."

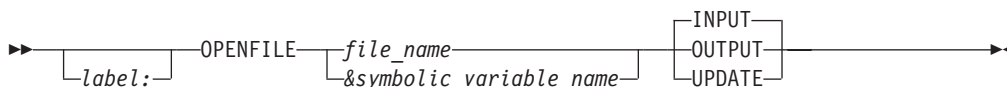

*label*

A name the CLIST can reference in a GOTO statement to branch to this OPENFILE statement. *label* is one-to-31 alphameric characters, beginning with an alphabetic character.

*file\_name* | *symbolic\_variable\_name*

*file\_name*

The file name (ddname) you assigned to the file (data set) when allocating it in the current session.

*symbolic\_variable\_name*

The symbolic variable to which you assigned *file\_name*.

**INPUT | OUTPUT | UPDATE**

**INPUT**

Open the file for input.

**OUTPUT**

Open the file for output.

**UPDATE**

Open the file for updating in place; that is, the CLIST can execute GETFILE and PUTFILE statements before closing the file.

**PROC Statement**

Use the PROC statement to:

- Define parameters to be passed on the EXEC command to the CLIST. In this case PROC is optional, but if you use it, it must be the first executable statement in the CLIST.
- Define a subprocedure and any parameters passed on the SYSCALL statement to the subprocedure. A subprocedure must begin with a PROC statement. In this case the PROC statement must have a label, and a corresponding END statement to mark the end of the subprocedure.

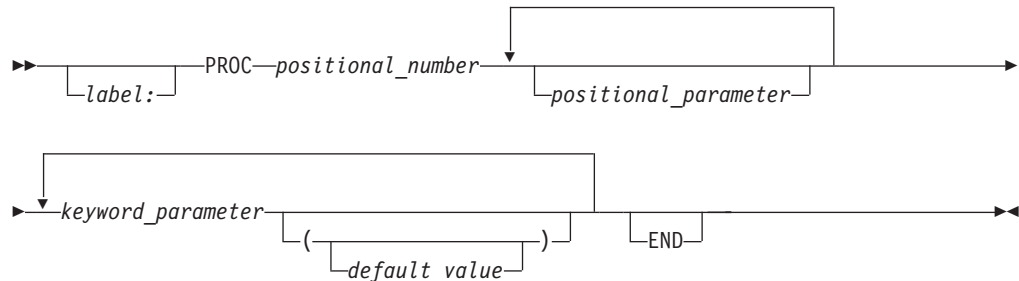

*label*

A name the CLIST can reference in a SYSCALL statement to pass control to this PROC statement. Required on PROC statements that begin subprocedures, *label* is one-to-31 alphameric characters, beginning with an alphabetic character.

*positional\_number*

The number of required positional parameters to be passed. Enter 1-5 decimal digits. If none, enter 0.

*positional\_parameter*

A positional parameter passed to the CLIST or subprocedure.

## PROC Statement

A positional parameter name may be 1-252 alphameric characters in length, beginning with an alphabetic character. Lowercase values are changed to uppercase.

If the name of a positional parameter on the PROC statement is the same as the name of a GLOBAL variable, an error occurs.

### *keyword\_parameter*

A keyword parameter passed to the CLIST or subprocedure.

A keyword parameter name can be 1-31 alphameric characters in length, beginning with an alphabetic character, and cannot contain the character underscore (\_). Lowercase values are changed to uppercase.

### *default\_value*

The value assigned to the corresponding variable in the CLIST or subprocedure if the user does not specify a value on the associated keyword on the EXEC command or SYSCALL statement.

If the value is omitted (empty parentheses) the user may supply a value on the associated keyword on the EXEC command or SYSCALL statement.

**Note:** Symbolic substitution does not occur for default values of a keyword parameter.

All parameters have an initial value at the time the CLIST or subprocedure begins execution. Each parameter name becomes the name of a symbolic variable that has the initial value of the associated parameter. The values of passed parameters are in effect only while the CLIST or subprocedure is active. Values passed in lowercase are converted to uppercase by the exec command.

---

## PUTFILE Statement

Use the PUTFILE statement to write a record to an open QSAM file. Each execution of PUTFILE writes one record. Unless the user wants the same record sent more than once, the file name variable must be assigned a different record using an assignment statement before the next PUTFILE statement is issued.

**Note:** The PUTFILE statement must be issued in the same CLIST as the corresponding OPENFILE statement.

►► `[label:] PUTFILE—file_name—` ◀◀

### *label*

A name the CLIST can reference in a GOTO statement to branch to this PUTFILE statement. *label* is one-to-31 alphameric characters, beginning with an alphabetic character.

### *file\_name*

The file name (ddname) assigned to the file (data set) when it was allocated in the current session. Do not specify a symbolic variable containing the file name.



---

## READ Statement

Use the READ statement to read input from the terminal and store it in symbolic variables. These variables may be defined on the READ statement or elsewhere in the CLIST. The READ statement is usually preceded by a WRITE or WRITENR statement that requests the user to enter the expected input at the terminal.

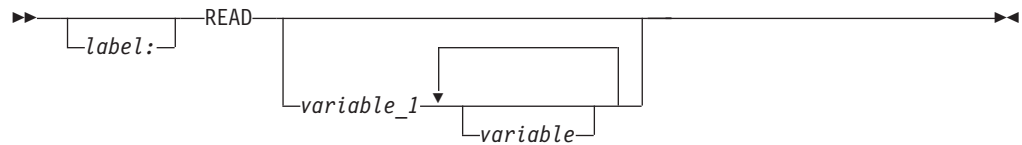

### *label*

A name the CLIST can reference in a GOTO statement to branch to this READ statement. *label* is one-to-31 alphanumeric characters, beginning with an alphabetic character.

### *variable\_1* / *variable*

Any valid variable name. The variables are positional in that values in the input data entered by the terminal user are stored sequentially into the specified variables.

If the operand is omitted the input is stored in the &SYSDVAL control variable.

---

## READDVAL Statement

Use the READDVAL statement to assign the current contents of the &SYSDVAL control variable to one or more specified symbolic variables.

The assignment is done sequentially to the variables in the order specified; variables not assigned values default to null values. If there are more values than variables, the excess values from &SYSDVAL are not assigned.

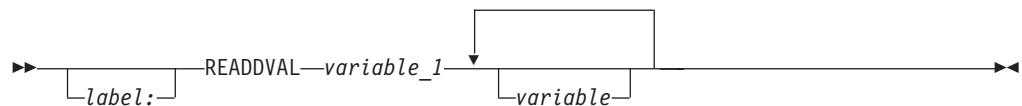

### *label*

provides a name the CLIST can reference in a GOTO statement to branch to this READDVAL statement. *label* is one-to-31 alphanumeric characters, beginning with an alphabetic character.

### *variable\_1* / *variable*

Any valid variable name. A variable need not have been previously defined.

---

## RETURN Statement

Use the RETURN statement to:

- Return control from an error routine or an attention routine to the statement following the one that ended in error or the one that was interrupted by an attention.
- Provide a return code from a subprocedure. Control will pass to the statement following the SYSCALL statement that called the subprocedure. The return code

## RETURN Statement

is stored in the control variable &LASTCC (Note, however, that return codes from CLIST subprocedures do *not* cause an error routine to receive control.)

RETURN is valid only when issued from a subprocedure, an activated error routine, or an activated attention routine. If issued from any other place, RETURN is treated as a no-operation.

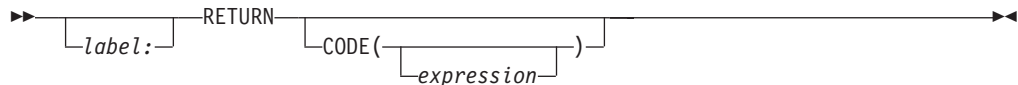

### *label*

A name the CLIST can reference in a GOTO statement to branch to this RETURN statement. *label* is one-to-31 alphameric characters, beginning with an alphabetic character.

### **CODE**

Subprocedures can issue a return code. Control will pass to the statement following the SYSCALL statement that called the subprocedure.

### *expression*

A CLIST-defined return code. *expression* can be a character string, a decimal integer, or an expression that evaluates to a decimal integer. The expression is stored in the control variable &LASTCC. If CODE appears without an expression, &LASTCC takes a null value.

---

## SELECT Statement

Use the SELECT statement to conditionally perform one of several alternative actions. There are two forms of the SELECT statement: the simple SELECT and the compound SELECT.

### Simple SELECT

In the simple SELECT statement, the CLIST tests one or more expressions. When the CLIST finds an expression that evaluates to a true value, the CLIST performs the associated action, then passes control to the END statement. If none of the expressions are true, the CLIST performs the action on the OTHERWISE clause, if any, or passes control to the END statement.

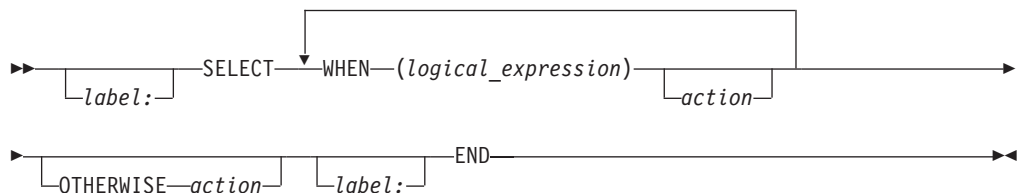

### *label*

A name the CLIST can reference in a GOTO statement to branch to this SELECT statement. *label* is one-to-31 alphameric characters, beginning with an alphabetic character.

### *logical\_expression*

A comparative expression, such as &A = 3 or &B -> 10, that evaluates to a true or false condition.

*action*

Any CLIST statement, TSO/E command, or DO sequence. A null action passes control to the END statement. The action can include nested IF, DO, and SELECT statements. Any statements in the action can have labels, allowing GOTO statements to branch to them.

**Compound SELECT**

A compound SELECT statement includes an initial test expression. The CLIST evaluates the test expression and compares its value to those of the WHEN expressions.

In a compound SELECT statement, a WHEN expression can contain multiple expressions separated by the logical operator | (OR). WHEN expressions can also include ranges of values, represented by a colon (:) between the lowest and highest values of the range. For example, 3:5 represents 3, 4, and 5.

When a test expression matches a value or falls within a range of values in a WHEN expression, the CLIST performs the associated action and passes control to the END statement. If no matches are found, the CLIST performs the action on the OTHERWISE clause, if any, or passes control to the END statement.

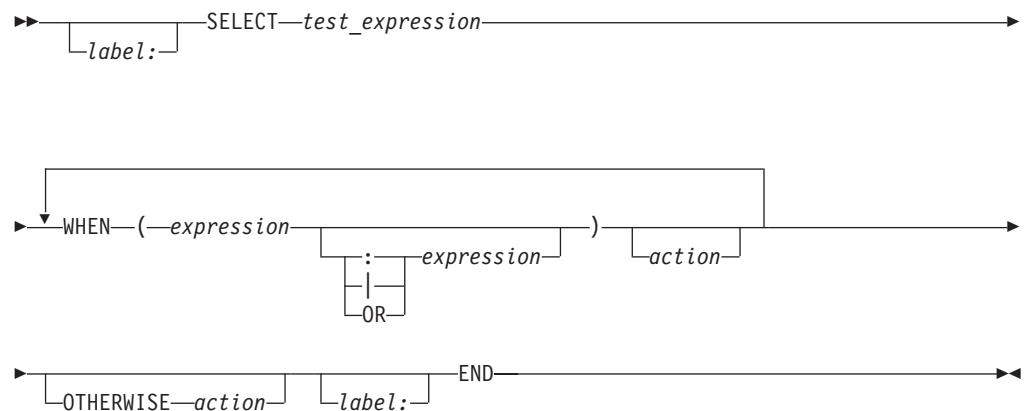

*label*

A name the CLIST can reference in a GOTO statement to branch to this SELECT statement. *label* is one-to-31 alphameric characters, beginning with an alphabetic character.

*test\_expression*

A character string or a logical expression that results in a value to be compared to the expressions in the WHEN clauses.

*expression*

A character string, a single logical expression, or a range such as 1:5. Values and ranges can be combined, for example: WHEN (&A-3 | &B | 4:6)

*action*

Any CLIST statement, TSO/E command, or DO sequence. A null action passes control to the END statement. The action can include nested IF, DO, and SELECT statements. Any statements in the action can have labels of their own.

## SET Statement

Use the SET statement to assign a value to a symbolic variable or a control variable.

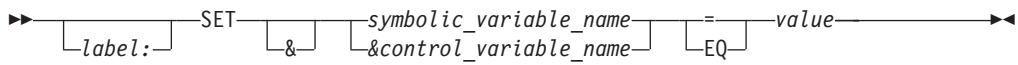

*label*

A name the CLIST can reference in a GOTO statement to branch to this SET statement. *label* is one-to-31 alphameric characters, beginning with an alphabetic character.

*symbolic\_variable\_name* | *control\_variable\_name*

*symbolic\_variable\_name*

The symbolic variable to which you are assigning a value.

*control\_variable\_name*

The control variable to which you are assigning a value. (See Table 4 on page 30 for those control variables that you can modify.)

**EQ** | =

The operator 'equal'.

*value*

Any valid numeric value or character string.

## SYSCALL Statement

Use the SYSCALL statement to pass control to a subprocedure. The SYSCALL statement contains the name of the subprocedure and any parameters to be passed. The name of the subprocedure must match the label on the PROC statement that begins the subprocedure.

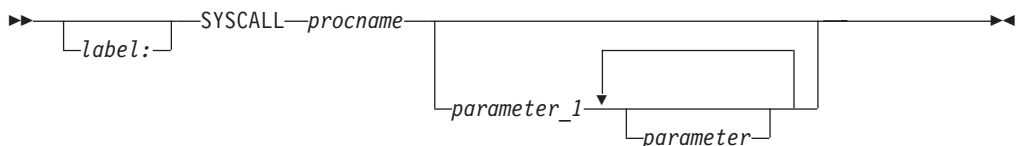

*label*

A name the CLIST can reference in a GOTO statement to branch to this SYSCALL statement. *label* is one-to-31 alphameric characters, beginning with an alphabetic character.

*procname*

The label of the PROC statement that begins the subprocedure.

*parameter\_1* | *parameter*

Any valid CLIST expression, including constants, symbolic variables, built-in functions, and arithmetic expressions. All parameters are separated by CLIST delimiters (blanks, commas, or tabs). For information about how to pass a parameter that contains blanks, see "Calling a Subprocedure" on page 75.

If the parameter is the name of a variable that is referred to in a SYSREF statement in the subprocedure, the variable name must not include an ampersand on the SYSCALL statement.

## SYSCALL Statement

The PROC statement of the subprocedure is responsible for defining variables to receive the parameters.

```

SET &A = John
SET &B = AL
SYSCALL XYZ &A B /* pass variables to XYZ, omitting & from
 /* the variable name referenced on SYSREF
 /* result: GEORGE
.
WRITE &B
.
.
XYZ: PROC 2 PARM1 PARM2 /* Subprocedure XYZ */
.
SYSREF &PARM2 /* indicate PARM2 holds a variable name
WRITE &PARM2 /* result: AL
SET &PARM2 = GEORGE
END

```

## SYSREF Statement

Use the SYSREF statement in a subprocedure to identify the names of variables, passed from the caller, whose values the subprocedure can reference and modify. When you assign a new value to a SYSREF variable, the new value is retroactive; that is, the new value takes effect in the caller as well as in the subprocedure.

On the SYSREF statement in the subprocedure, list the PROC statement parameter that corresponds to the variable name that the caller passed. The SYSREF statement must precede any subprocedure statement that uses its variables.

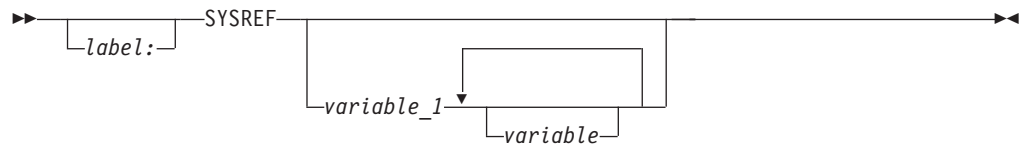

### *label*

A name the CLIST can reference in a GOTO statement to branch to this SYSREF statement. *label* is one-to-31 alphameric characters, beginning with an alphabetic character.

### *variable\_1* | *variable*

The name of a parameter from the PROC statement. The parameters correspond to variable names that were passed to the PROC statement. Ampersands (&) are optional on the variable name.

In the following example, the subprocedure assigns a new value to the variable whose name was passed (B). The new value (GEORGE) replaces the variable's old value (AL) in the caller.

## SYSREF Statement

```

SET &A = John
SET &B = AL
SYSCALL XYZ &A B
.
WRITE &A
WRITE &B
.
XYZ: PROC 2 PARM1 PARM2
.
 SET &parm1 = Joe
 WRITE &parm1
 SYSREF &PARM2
 WRITE &PARM2
 SET &PARM2 = GEORGE
END

```

/\* pass variables to XYZ, omitting & from  
 /\* the variable name referenced on SYSREF  
 /\* result: JOHN (original value)  
 /\* result: GEORGE (changed value)

/\* Subprocedure XYZ \*/

/\* change value of &parm1  
 /\* result: JOE  
 /\* indicate PARM2 holds a variable name  
 /\* result: AL  
 /\* change value of SYSREF variable

## TERMIN and TERMING Statement

Use the TERMIN or TERMING statement to pass control from the CLIST to the terminal user. You can also use TERMIN or TERMING to define the character strings, including a null line, that a user enters to return control to the CLIST. TERMIN is usually preceded by a WRITE statement that requests the expected response from the terminal user.

The TERMIN or TERMING statement ends a CLIST when you issue a CLIST in any of the following ways:

- Under ISPF
- In the background
- From a REXX exec (a nested CLIST)

Control returns to the CLIST at the statement after TERMIN or TERMING. When control returns, &SYSDLM and &SYSDVAL have been set.

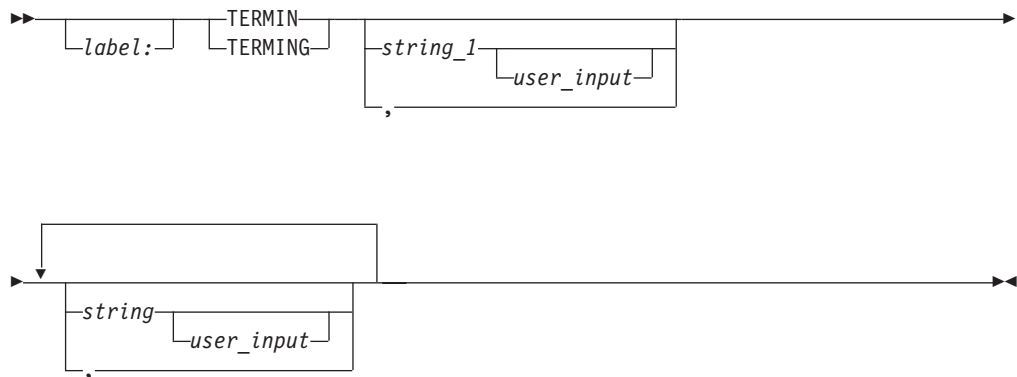

### label

A name the CLIST can reference in a GOTO statement to branch to this TERMIN statement. *label* is one-to-31 alphanumeric characters, beginning with an alphabetic character.

### TERMIN | TERMING

transfers control to the terminal and establishes a means for the user to return control to the CLIST.

### TERMIN

A CLIST executed from the TERMIN is *not* considered nested within the CLIST that issued the TERMIN statement, which has the following effects:

## TERMIN and TERMING Statement

- Sharing GLOBAL variables - GLOBAL variables *cannot* be shared across the TERMIN. Global variable sharing between the CLIST executed from the TERMIN and the CLIST that issued the TERMIN is *not* allowed.
- Variable access - variable access across the TERMIN *cannot* be communicated through the CLIST variable access routine IKJCT441.
- Checking command output trapping (&SYSOUTTRAP) - IKJCT441 and IRXEXCOM *do not* recognize CLISTS or REXX execs on opposing sides of a TERMIN element.
- CONTROL NOMSG statement - checking the NOMSG setting on opposing sides of a TERMIN element is *not* allowed.

### TERMING

A CLIST executed from the TERMING is considered nested within the CLIST that issued the TERMING statement, which has the following effects:

- Sharing GLOBAL variables - GLOBAL variables can be shared across the TERMING. Global variable sharing between the CLIST executed from the TERMING and the CLIST that issued the TERMING is allowed.
- Variable access - variable access across the TERMING can be communicated through the CLIST variable access routine IKJCT441.
- Checking command output trapping (&SYSOUTTRAP) - IKJCT441 and IRXEXCOM recognize CLISTS or REXX execs on opposing sides of a TERMING element.
- CONTROL NOMSG statement - checking the NOMSG setting on opposing sides of a TERMING element is allowed.

#### *string\_1* | *string*

A character string that the terminal user enters to return control to the CLIST.

The &SYSDLM control variable contains a number corresponding to the position of the string that the user entered (1 for string<sub>1</sub>, 2 for string<sub>2</sub>, and so on).

#### *user\_input*

Additional input entered by the terminal user. The input is stored in the &SYSDVAL control variable.

- , If you specify a comma in place of a string, the terminal user can enter a null line (press the Enter key) to return control to the CLIST.

If no operands are specified the terminal user enters a null line to return control to the CLIST.

---

## WRITE and WRITENR Statements

Use the WRITE and WRITENR statements to define text and have it displayed at the terminal. This text can be used for messages, information, or prompting.

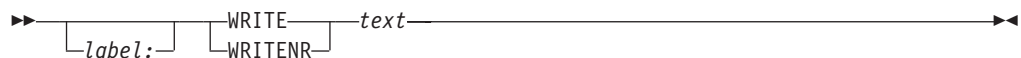

#### *label*

A name the CLIST can reference in a GOTO statement to branch to this WRITE/WRITENR statement. *label* is one-to-31 alphameric characters, beginning with an alphabetic character.

### WRITE | WRITENR

#### WRITE

The cursor moves to a new line after the text is displayed.

## WRITE and WRITENR Statements

### WRITENR

The cursor does not move to a new line after the text is displayed.

*text*

What is displayed at the terminal. You can enter any character string, including symbolic variables. Unless you enclose an arithmetic expression in an &EVAL built-in function, the WRITE/WRITENR statement does not perform evaluation on the expression. The CLIST also displays any comments on the same line as the WRITE/WRITENR statement.

---

## END Command

For information about the END command, see *z/OS TSO/E Command Reference*.

---

## EXEC Command

For a description of the EXEC command, see *z/OS TSO/E Command Reference*.



---

## Appendix. Accessibility

Accessibility features help a user who has a physical disability, such as restricted mobility or limited vision, to use software products successfully. The major accessibility features in z/OS™ enable users to:

- Use assistive technologies such as screen-readers and screen magnifier software
- Operate specific or equivalent features using only the keyboard
- Customize display attributes such as color, contrast, and font size

---

### Using assistive technologies

Assistive technology products, such as screen-readers, function with the user interfaces found in z/OS. Consult the assistive technology documentation for specific information when using it to access z/OS interfaces.

---

### Keyboard navigation of the user interface

Users can access z/OS user interfaces using TSO/E or ISPF. Refer to *z/OS TSO/E Primer*, *z/OS TSO/E User's Guide*, and *z/OS ISPF User's Guide Volume I* for information about accessing TSO/E and ISPF interfaces. These guides describe how to use TSO/E and ISPF, including the use of keyboard shortcuts or function keys (PF keys). Each guide includes the default settings for the PF keys and explains how to modify their functions.



---

## Notices

This information was developed for products and services offered in the U.S.A.

IBM may not offer the products, services, or features discussed in this document in other countries. Consult your local IBM representative for information on the products and services currently available in your area. Any reference to an IBM product, program, or service is not intended to state or imply that only that IBM product, program, or service may be used. Any functionally equivalent product, program, or service that does not infringe any IBM intellectual property right may be used instead. However, it is the user's responsibility to evaluate and verify the operation of any non-IBM product, program, or service.

IBM may have patents or pending patent applications covering subject matter described in this document. The furnishing of this document does not give you any license to these patents. You can send license inquiries, in writing, to:

IBM Director of Licensing  
IBM Corporation  
North Castle Drive  
Armonk, NY 10504-1785  
USA

For license inquiries regarding double-byte (DBCS) information, contact the IBM Intellectual Property Department in your country or send inquiries, in writing, to:

IBM World Trade Asia Corporation  
Licensing  
2-31 Roppongi 3-chome, Minato-ku  
Tokyo 106, Japan

**The following paragraph does not apply to the United Kingdom or any other country where such provisions are inconsistent with local law:**

INTERNATIONAL BUSINESS MACHINES CORPORATION PROVIDES THIS PUBLICATION "AS IS" WITHOUT WARRANTY OF ANY KIND, EITHER EXPRESS OR IMPLIED, INCLUDING, BUT NOT LIMITED TO, THE IMPLIED WARRANTIES OF NON-INFRINGEMENT, MERCHANTABILITY OR FITNESS FOR A PARTICULAR PURPOSE. Some states do not allow disclaimer of express or implied warranties in certain transactions, therefore, this statement may not apply to you.

This information could include technical inaccuracies or typographical errors. Changes are periodically made to the information herein; these changes will be incorporated in new editions of the publication. IBM may make improvements and/or changes in the product(s) and/or the program(s) described in this publication at any time without notice.

Any references in this information to non-IBM Web sites are provided for convenience only and do not in any manner serve as an endorsement of those Web sites. The materials at those Web sites are not part of the materials for this IBM product and use of those Web sites is at your own risk.

IBM may use or distribute any of the information you supply in any way it believes appropriate without incurring any obligation to you.

## Notices

Licensees of this program who wish to have information about it for the purpose of enabling: (i) the exchange of information between independently created programs and other programs (including this one) and (ii) the mutual use of the information which has been exchanged, should contact:

IBM Corporation  
Mail Station P300  
2455 South Road  
Poughkeepsie, NY 12601-5400  
USA

Such information may be available, subject to appropriate terms and conditions, including in some cases, payment of a fee.

The licensed program described in this information and all licensed material available for it are provided by IBM under terms of the IBM Customer Agreement, IBM International Program License Agreement, or any equivalent agreement between us.

Any performance data contained herein was determined in a controlled environment. Therefore, the results obtained in other operating environments may vary significantly. Some measurements may have been made on development-level systems and there is no guarantee that these measurements will be the same on generally available systems. Furthermore, some measurement may have been estimated through extrapolation. Actual results may vary. Users of this document should verify the applicable data for their specific environment.

Information concerning non-IBM products was obtained from the suppliers of those products, their published announcements or other publicly available sources. IBM has not tested those products and cannot confirm the accuracy of performance compatibility or any other claims related to non-IBM products. Questions on the capabilities of non-IBM products should be addressed to the suppliers of those products.

All statements regarding IBM's future direction or intent are subject to change without notice, and represent goals and objectives only.

This information contains examples of data and reports used in daily business operations. To illustrate them as completely as possible, the examples include the names of individuals, companies, brands, and products. All of these names are fictitious and any similarity to the names and addresses used by an actual business enterprise is entirely coincidental.

### COPYRIGHT LICENSE:

This information contains sample application programs in source language, which illustrates programming techniques on various operating platforms. You may copy, modify, and distribute these sample programs in any form without payment to IBM, for the purposes of developing, using, marketing or distributing application programs conforming to the application programming interface for the operating platform for which the sample programs are written. These examples have not been thoroughly tested under all conditions. IBM, therefore, cannot guarantee or imply reliability, serviceability, or function of these programs. You may copy, modify, and distribute these sample programs in any form without payment to IBM for the purposes of developing, using, marketing, or distributing application programs conforming to IBM's application programming interfaces.

If you are viewing this information softcopy, the photographs and color illustrations may not appear.

---

## **Programming Interface Information**

This document describes intended Programming Interfaces that allow the customer to write programs to obtain the services of z/OS TSO/E.

---

## **Trademarks**

The following terms are trademarks of the IBM Corporation in the United States or other countries or both:

- DFSMS/MVS
- DFSMSHsm
- IBM
- IBMLink
- MVS
- MVS/DFP
- MVS/ESA
- OS/390
- RACF
- Resource Link
- SP
- VTAM
- z/OS
- z/OS.e
- zSeries

UNIX is a registered trademark of The Open Group in the United States and other countries.

Other company, product, and service names may be trademarks or service marks of others.



---

## Bibliography

This section lists the books in the TSO/E library and related publications.

---

### TSO/E Publications

#### TSO/E Publications

- *z/OS TSO/E Administration*, SA22-7780
- *z/OS TSO/E CLISTs*, SA22-7781
- *z/OS TSO/E Command Reference*, SA22-7782
- *z/OS TSO/E Customization*, SA22-7783
- *z/OS TSO/E General Information*, SA22-7784
- *z/OS TSO/E Guide to SRPI*, SA22-7785
- *z/OS TSO/E Messages*, SA22-7786
- *z/OS TSO/E Primer*, SA22-7787
- *z/OS TSO/E Programming Guide*, SA22-7788
- *z/OS TSO/E Programming Services*, SA22-7789
- *z/OS TSO/E REXX Reference*, SA22-7790
- *z/OS TSO/E REXX User's Guide*, SA22-7791
- *z/OS TSO/E System Programming Command Reference*, SA22-7793
- *z/OS TSO/E System Diagnosis: Data Areas*, GA22-7792
- *z/OS TSO/E User's Guide*, SA22-7794

---

### Related Publications

#### z/OS MVS Publications

- *z/OS MVS Planning: APPC/MVS Management*, SA22-7599
- *z/OS MVS Programming: Writing Transaction Programs for APPC/MVS*, SA22-7621
- *z/OS MVS Initialization and Tuning Reference*, SA22-7592
- *z/OS MVS Programming: Authorized Assembler Services Guide*, SA22-7608
- *z/OS MVS Programming: Authorized Assembler Services Reference ALE-DYN*, SA22-7609
- *z/OS MVS System Messages, Vol 1 (ABA-AOM)*, SA22-7631
- *z/OS MVS System Messages, Vol 2 (ARC-ASA)*, SA22-7632
- *z/OS MVS System Messages, Vol 3 (ASB-BPX)*, SA22-7633
- *z/OS MVS System Messages, Vol 4 (CBD-DMO)*, SA22-7634
- *z/OS MVS System Messages, Vol 5 (EDG-GFS)*, SA22-7635
- *z/OS MVS System Messages, Vol 6 (GOS-IEA)*, SA22-7636
- *z/OS MVS System Messages, Vol 7 (IEB-IEE)*, SA22-7637
- *z/OS MVS System Messages, Vol 8 (IEF-IGD)*, SA22-7638
- *z/OS MVS System Messages, Vol 9 (IGF-IWM)*, SA22-7639
- *z/OS MVS System Messages, Vol 10 (IXC-IZP)*, SA22-7640
- *z/OS MVS System Codes*, SA22-7626
- *z/OS MVS Data Areas, Vol 1 (ABEP-DALT)*, GA22-7581
- *z/OS MVS Data Areas, Vol 2 (DCCB-ITZYRETC)*, GA22-7582

## Bibliography

- *z/OS MVS Data Areas, Vol 3 (IVT-RCWK)*, GA22-7583
- *z/OS MVS Data Areas, Vol 4 (RD-SRRA)*, GA22-7584
- *z/OS MVS Data Areas, Vol 5 (SSAG-XTLST)*, GA22-7585

### **ISPF Publications**

- *z/OS ISPF Services Guide*, SC34-4819
- *z/OS ISPF Dialog Developer's Guide and Reference*, SC34-4821



---

# Index

## Special characters

- (minus sign) 13  
/ (division symbol)  
    as an arithmetic operator 13  
// (remainder symbol)  
    as an arithmetic operator 13  
\* (multiplication symbol)  
    as an arithmetic operator 13  
\*\* (exponentiation symbol)  
    as an arithmetic operator 13  
> (greater than symbol) 14  
>= (greater than or equal to) 14  
< (less than symbol) 14  
<= (less than or equal to) 14  
| (logical OR symbol) 14  
&& (logical AND symbol) 14  
&DATATYPE built-in function 52  
&EVAL built-in function 53  
&LASTCC  
    See CLIST variable  
&LASTCC control variable 47  
&LENGTH built-in function 53  
&MAXCC control variable 48  
&NRSTR built-in function 54  
&STR built-in function 55  
&SUBSTR built-in function 57  
&SYS4DATE control variable 33  
&SYS4JDATE control variable 33  
&SYS4SDATE control variable 33  
&SYSABNCD control variable 49  
&SYSABNRC control variable 49  
&SYSADIRBLK  
    See CLIST variable  
&SYSALLOC  
    See CLIST variable  
&SYSAPPCLU control variable 37  
&SYSASIS control variable 44  
&SYSBLKSIZE  
    See CLIST variable  
&SYSBLKSTRK  
    See CLIST variable  
&SYSCAPS built-in function 59  
&SYSLENGTH built-in function 54  
&SYSCLONE control variable 35  
    possible uses 35  
&SYSCONLIST control variable 43  
&SYSCPU control variable 36  
&SYSCREATE  
    See CLIST variable  
&SYSCSUBSTR built-in function 59  
&SYSDATACLASS  
    See CLIST variable  
&SYSDATE control variable 32  
&SYSDFP control variable 36  
&SYSDLM control variable 45  
&SYSDSN built-in function 59

&SYSDSNAME  
    See CLIST variable  
&SYSDSORG  
    See CLIST variable  
&SYSDSSMS  
    See CLIST variable  
&SYSDVAL control variable 45  
&SYSENV control variable 41  
&SYSEXDATE  
    See CLIST variable  
&SYSEXTENTS  
    See CLIST variable  
&SYSFLUSH control variable 44  
&SYSHSM control variable 36  
&SYSICMD control variable 42  
&SYSINDEX built-in function 60  
&SYSISPF control variable 37  
&SYSJDATE control variable 32  
&SYSJES control variable 37  
&SYSKEYLEN  
    See CLIST variable  
&SYSLC built-in function 59  
&SYSLIST control variable 43  
&SYSLRACF control variable 37  
&SYSLRECL  
    See CLIST variable  
&SYSLTERM control variable 34  
&SYSTEMMEMBERS  
    See CLIST variable  
&SYSMGMTCLASS  
    See CLIST variable  
&SYSMSG control variable 44  
&SYSMSGLVL1  
    See CLIST variable  
&SYSMSGLVL2  
    See CLIST variable  
&SYSMVS control variable 38  
&SYSNAME control variable 38  
    possible uses 35  
&SYSNEST control variable 42  
&SYSNODE control variable 38  
&SYSNSUB built-in function 62  
&SYSONEBYTE built-in function 63  
&SYSOPSYS control variable 39  
&SYSOUTLINE control variable 46  
&SYSOUTTRAP control variable 46  
&SYSPASSWORD  
    See CLIST variable  
&SYSPCMD control variable 42  
&SYSPLEX control variable 39  
    possible uses 35  
&SYSPREF control variable 34  
&SYSPRIMARY  
    See CLIST variable  
&SYSPROC control variable 35  
&SYSPROMPT control variable 43  
&SYSRACF control variable 39

- &SYSRACFA
  - See CLIST variable
- &SYSREASON
  - See CLIST variable
- &SYSRECFM
  - See CLIST variable
- &SYSREFDATE
  - See CLIST variable
- &SYSSCAN control variable 42
- &SYSSCMD control variable 42
- &SYSSDATE control variable 32
- &SYSSECLAB control variable 40
- &SYSSECONDS
  - See CLIST variable
- &SYSSMFID control variable 40
- &SYSSMS control variable 40
- &SYSSRV control variable 36
- &SYSSTIME control variable 33
- &SYSSTORCLASS
  - See CLIST variable
- &SYSSYMDEF control variable 40
- &SYSSYMLIST control variable 43
- &SYSTEMID control variable 34
- &SYSTIME control variable 33
- &SYSTRKSCYL
  - See CLIST variable
- &SYSTSOE control variable 41
- &SYSTWOBYTE built-in function 63
- &SYSUDIRBLK
  - See CLIST variable
- &SYSUID control variable 34
- &SYSUNIT
  - See CLIST variable
- &SYSUNITS
  - See CLIST variable
- &SYSUPDATED
  - See CLIST variable
- &SYSUSED
  - See CLIST variable
- &SYSUSEDPAGES
  - See CLIST variable
- &SYSVOLUME
  - See CLIST variable
- &SYSWTERM control variable 34
- + (plus sign)
  - as an arithmetic operator 13
- ++
  - as an arithmetic operator 13
- = (equal sign) 14
- > (not greater than) 14
- < (not less than) 14
- = (not equal sign) 14

## A

- accessibility 181
- action
  - of an attention routine
    - attention interrupt 101
    - cancelling 102
    - protecting the input stack for 102

- action (*continued*)
  - of an attention routine (*continued*)
    - protecting using the MAIN operand of CONTROL 102
  - of an error routine 105
    - cancelling 105
    - listing instruction causing error 105
    - protecting the input stack for 106
    - protecting using MAIN or NOFLUSH operand of CONTROL 106
- ALLOCATE CLIST
  - attention routine 103
- allocating CLIST libraries
  - implicit execution 6
- allocation information
  - retrieving with LISTDSI 49
- alphameric character
  - definition of 11, 152
- ALTLIB command
  - example 8
  - specifying alternative CLIST libraries with 7
  - using under ISPF 7
- ampersand (&)
  - in the SET statement 19
  - meaning of, preceding a variable name 17
  - using double ampersands 24
- AND
  - logical operator 13
- APPC/MVS
  - finding name 37
- application
  - CLIST 2
  - different languages
    - using CLIST to manage 2
  - full-screen
    - writing 137
- arithmetic expression
  - creating from user supplied input 119
- arithmetic operator 13
- ASIS
  - CONTROL statement operand 44, 155
- assigning value
  - to symbolic variable 19
- attention facility for CLIST 104
- attention handling CLIST 102
  - example 104
- attention interrupt 101
  - cancelling action for 102
  - defining action 101
  - protecting the input stack for 102
- attention routine
  - cancelling 102
  - establishing 101
  - example 103
  - protecting the input stack for 102
- ATTN statement
  - creating a CLIST attention routine with 101
  - protecting the input stack for 102
  - syntax 152
  - using in a subprocedure 78

attribute, data set  
  default 4  
  retrieving with LISTDSI 49  
availability test  
  data set 59

## B

background  
  executing a CLIST 6  
  executing a job from a CLIST  
  example 127  
  tailoring a CLIST for background execution, using  
  &SYSENV 41  
base control program  
  finding level of 38  
BCP  
  finding level of 38  
branching within a CLIST  
  using GOTO statement 81  
built-in function 51  
  &DATATYPE 52  
  &EVAL 53  
  &LENGTH 53  
  &NRSTR 54  
  &STR 55  
  &SUBSTR 57  
  &SYSCAPS 59  
  &SYSCLENGTH 54  
  &SYSCSUBSTR 59  
  &SYSDSN 59  
  &SYSINDEX 60  
  &SYSLC 59  
  &SYSNSUB 62  
  &SYSONEBYTE 63  
  &SYSTWOBYTE 63  
  overview 51  
  writing your own 52  
BY expression  
  in an iterative DO loop 72

## C

CALC CLIST  
  adding front-end prompting to 119  
  creating arithmetic expression from input 119  
CALCFTND CLIST 119  
capital letter  
  converting from lowercase  
  with &SYSCAPS 59  
  with CONTROL CAPS 155  
  converting to lowercase  
  with &SYSLC 59  
capitalization in a CLIST 10  
CAPS  
  CONTROL statement operand 155  
CASH CLIST 131  
category of CLIST  
  managing applications written in other languages 2  
  performing routine tasks 1  
  self-contained applications 1

character set  
  double-byte 15  
  supported in CLIST 12  
  supported in I/O 95  
CLIST  
  attention facility 104  
  data set  
  copying 4  
  creating 3  
  default attributes 4  
  editing 3  
  debugging 109  
  error code 111  
  executing 5  
  language 1  
  library 3  
  allocating using ALTLIB 8  
  implicit execution 6  
  installation-defined 3  
  user-defined 3  
  naming restrictions 3  
  reserved words 3  
  restriction on naming 3  
  statement  
  list of 9  
  writing your own 10  
  testing 109  
CLIST variable  
  set by LISTDSI  
  &LASTCC 167  
  &SYDSORG 165  
  &SYSADIRBLK 167  
  &SYSALLOC 166  
  &SYSBLKSIZE 166  
  &SYSBLKSTRK 167  
  &SYSCREATE 166  
  &SYSDATACLASS 168  
  &SYSDSNAME 165  
  &SYSDSSMS 168  
  &SYSEXDATE 166  
  &SYSEXTENTS 166  
  &SYSKEYLEN 166  
  &SYSRECL 166  
  &SYSMEMBERS 167  
  &SYSMGMTCLASS 168  
  &SYMSGLVL1 167  
  &SYMSGLVL2 167  
  &SYSPASSWORD 166  
  &SYSPRIMARY 166  
  &SYSRACFA 167  
  &SYSREASON 167  
  &SYSRECFM 166  
  &SYSREFDATE 166  
  &SYSSECONDS 166  
  &SYSSTORCLASS 168  
  &SYSTRKSCYL 167  
  &SYSUDIRBLK 167  
  &SYSUNIT 165  
  &SYSUNITS 166  
  &SYSUPDATED 167  
  &SYSUSED 166

- CLIST variable *(continued)*
  - set by LISTDSI *(continued)*
    - &SYSUSEDPAGES 166
    - &SYSVOLUME 165
- CLOSEFILE statement
  - syntax 153
  - using 96
- closing a file 96
- code, error
  - list of 111
- coding statements and commands 149
- combining variable 23
- command
  - installation-written
    - distinguishing from CLIST statement name 56
  - TSO/E
    - using in a CLIST 1, 12
- commands
  - naming restrictions 3
  - restriction on naming 3
- comment, in a CLIST 11
- comparative operator 13
- compound DO sequence
  - using to create a loop 72
- compound SELECT statement
  - using 175
- compound variable 23
- COMPRESS CLIST 129
- compressing a data set 129
- concatenating
  - CLIST data set to SYSPROC
    - sample CLIST for 133
  - CLIST data sets with ALTLIB 7
  - compound 23
  - data set for I/O 99
  - variable 23
- continuation symbol 10
- CONTROL statement
  - syntax 154
  - using for CLIST diagnosis 109
  - using in a subprocedure 78
- control variable
  - See variable
- controlling
  - the display of messages 87
  - uppercase and lowercase
    - using &SYSLC and &SYSCAPS control variables 90
    - using CAPS operand of CONTROL 90
- converting READ statement input
  - to lowercase character (&SYSLC) 59
  - to uppercase character (&SYSCAPS) 59
- copying a CLIST
  - considerations 4
- creating a CLIST
  - TSO/E EDIT and full-screen editor 3

## D

- DATA PROMPT-ENDDATA sequence
  - syntax 156

- DATA PROMPT-ENDDATA sequence *(continued)*
  - using to code responses to prompts 85
- data set
  - allocating using ALTLIB
    - example 8
  - attribute
    - default 4
    - retrieving with LISTDSI 49
  - availability
    - checking with &SYSDSN 59
  - I/O
    - performing 95
  - information about attributes 162
  - name
    - determining qualification 125
    - performing substringing on 125
    - reading in a CLIST, precautions for 89
    - specifying on the EXEC command 5
- DATA-ENDDATA sequence
  - syntax 156
  - using to distinguish a command from a statement 75
- DATATYPE 52
- date formats, four-digit years
  - See also SYS4DATE
  - See also SYS4JDATE
  - See SYS4SDATE
- date formats, two-digit years
  - See also SYSDATE
  - See also SYSJDATE
  - See SYSSDATE
- date, obtaining the
  - in Julian form 32, 33
  - in sortable form 32, 33
  - in standard form 32, 33
- DBCS (double-byte character set) 15, 55
  - CLIST support 15
  - combining variables containing DBCS data 25
  - converting DBCS data to EBCDIC, using &SYSONEBYTE 63
  - converting EBCDIC data to DBCS, using &SYSTWOBYTE 63
  - counting DBCS bytes with &LENGTH 53
  - counting DBCS characters with &SYSCLENGTH 54
  - defining a DBCS string as character data
    - using &STR 55
  - determining if a string contains DBCS data, using &DATATYPE 52
  - error code involving DBCS 113
  - restriction on using DBCS data in CLIST
    - general 15
    - using &SYSINDEX 61
    - with EDIT command 4
  - subdividing strings containing DBCS characters
    - using &SUBSTR 58
    - using &SYSCSUBSTR 59
- debugging a CLIST 109
- defining
  - non-rescannable character string (&NRSTR) 54
  - real value (&STR) 55
  - substringing (&SUBSTR) 57

- defining (*continued*)
  - substring (&SYSCSUBSTR) 59
  - symbolic variable 19
- DELETEDS CLIST 118
- delimiter
  - delimiter for a DBCS string in a CLIST 15
  - for CLIST statement 10
  - for the double-byte character set 15
  - period
    - used to distinguish variable from data 125
- determining
  - an expression's data type (&DATATYPE) 52
  - an expression's length
    - in bytes (&LENGTH) 53
    - in characters (&SYSCLENGTH) 54
  - data set availability (&SYSDSN) 59
- DFHSM (Data Facility Hierarchical Storage Manager)
  - determining level
    - using &SYSHSM 36
- DFSMS/MVS
  - availability to CLISTs 40
- diagnostic procedure
  - for a CLIST 109
- dialog, ISPF
  - creating 94
  - sample 137
- disability 181
- displaying
  - CLIST statement
    - after substitution, using &SYSCONLIST 43
    - before substitution, using &SYSSYMLIST 43
  - panel from a CLIST 2
  - TSO/E commands
    - after substitution, using &SYSLIST 43
- distinguishing
  - END statement from END subcommand
    - in general 74
    - using the CONTROL statement 74
    - using the DATA-ENDDATA sequence 75
  - RACF SELECT subcommand from the SELECT statement 69
  - strings that match CLIST statement names 56
  - WHEN clause from WHEN command 69
- DO statement
  - syntax 156
- DO-END sequence
  - in an attention routine 101
  - using
    - in the IF-THEN-ELSE sequence 66
- DO-UNTIL-END sequence
  - using to create a loop 71
- DO-WHILE-END sequence
  - using to create a loop 70
- double ampersands
  - preserving, with &NRSTR 54
  - use of 24

## E

- EDIT command
  - creating a CLIST under 4
- EDIT command (*continued*)
  - executing a CLIST under 5
- editing a CLIST
  - TSO/E EDIT and full-screen editor 3
- END command 81
- END statement
  - distinguishing from END command or subcommand 74
  - syntax 158
- end-of-file processing
  - example 107
  - performing 98
- entry panel
  - PROFILE CLIST example 137, 138
- EQ (equal sign) 14
- error
  - cancelling action for 105
  - code
    - list of 111
    - obtaining in a CLIST 111
  - condition
    - end-of-file processing 98
  - defining action for 105
  - protecting the input stack from 106
  - routine
    - cancelling 105
    - creating 105
    - end-of-file 98
    - protecting the input stack for 106
    - sample CLIST 106
- error message
  - CLIST error routine 115
  - getting help for 111
  - viewing at the terminal 110
- ERROR statement 105
  - canceling error action using 105
  - listing instruction causing error 105
  - protecting the input stack for 106
  - syntax 158
  - using in a subprocedure 78
- EVAL 53
- evaluation
  - order of 14
- example of a CLIST
  - list of 117
- executing a CLIST
  - explicitly 5
  - finding how a CLIST was executed 42
  - implicitly 5
  - in general 5
- exit
  - installation
    - writing a built-in function 52
    - writing a CLIST 9
  - routine
    - establishing 101
- EXIT statement
  - syntax 159
  - to exit a CLIST specifying a return code 81
  - to exit a CLIST without specifying a return code 81

- exiting
  - CLIST using the END command 81
  - CLIST using the EXIT statement 81
    - specifying a return code 81
  - from a nested CLIST 80
- EXPAND CLIST 146
- explicit execution of a CLIST 5
- expression
  - arithmetic 13
  - comparative 13
  - logical 13
  - simple 13

**F**

- file input/output
  - performing 95
    - closing a file 96
    - end-of-file processing 98
    - on a JCL statement 99
    - on concatenated data set 99
    - opening a file 95
    - significance of file name 95
    - using &SYSDVAL 132
    - using READDVAL 132
  - reading a record from a file 96
  - updating a file 98
  - writing a record to a file 97
- file name
  - significance of in file I/O 95
- FLUSH option of CONTROL statement 155
- flushing the input stack
  - with &SYSFLUSH 44
- footprint (flag)
  - setting
    - in a CLIST 103
  - testing
    - in an attention handling CLIST 104
- forcing arithmetic evaluation 53
- foreground
  - executing a CLIST 6
  - executing a job from a CLIST
    - example 127
  - tailoring a CLIST for foreground execution using &SYSENV 41
- formatting in a CLIST 11
- front-end prompting
  - adding to the CALC CLIST 119
  - example 120, 125
- full-screen application
  - example 138
  - writing 137
- fully-qualified data set name
  - processing
    - example 125
- function
  - built-in
    - converting DBCS data to EBCDIC (&SYSONEBYTE) 63
    - converting EBCDIC data to DBCS (&SYSTWOBYTE) 63

- function (*continued*)
  - built-in (*continued*)
    - converting READ input to lowercase (&SYSLC) 59
    - converting READ input to uppercase (&SYSCAPS) 59
    - defining a non-rescannable character string (&NRSTR) 54
    - defining a real value (&STR) 55
    - defining a substring (&SUBSTR) 57
    - defining a substring (&SYSCSUBSTR) 59
    - determining data set availability (&SYSDSN) 59
    - limiting symbolic substitution (&SYSNSUB) 62
    - locating strings within strings (&SYSINDEX) 60
    - overview 51
  - built-in function
    - determining an expression's length in bytes (&LENGTH) 53
    - determining data type (&DATATYPE) 52
    - forcing arithmetic evaluation (&EVAL) 53
- function,
  - built-in 51
    - determining an expression's length in characters (&SYSCLENGTH) 54

**G**

- GE (greater than or equal to symbol) 14
- GETFILE statement
  - syntax 160
  - using 96
- GLOBAL statement
  - syntax 160
- global variable
  - establishing 80
  - example 80
  - in error routine
    - protecting using the MAIN operand of CONTROL 106
- GOTO statement
  - example 81
  - syntax 161
  - using in a subprocedure 78
- GT (greater than symbol) 14

**H**

- HOUSKPNG CLIST 102
- hyphen
  - as continuation symbol 10

**I**

- I/O
  - performing file 95
- IF-THEN-ELSE sequence
  - nesting 67
  - null ELSE format 67
  - null THEN format 67
  - standard format 66
  - syntax 162

- IF-THEN-ELSE sequence (*continued*)
  - using to make a decision 66
- implicit execution
  - allocating a CLIST for 6
  - benefit of 3
  - of a CLIST 5
- implicitly defining variable 19
- input
  - obtaining from the terminal 83
- input stack
  - protecting
    - for attention routine 102
    - for error routine 106
    - for nested CLISTS 79
    - using MAIN operand of CONTROL 102, 106
    - using NOFLUSH operand of CONTROL 106
- input string
  - performing substringing on
    - example 125
- installation exit
  - writing a built-in function 52
  - writing a CLIST 10
- Interactive System Productivity Facility (ISPF)
  - See ISPF (Interactive System Productivity Facility)
- intercepting
  - command output from a CLIST
    - example 133
  - command output from CLISTS
    - using &SYSOUTTRAP 46
- interface to application
  - simplifying 131
- interpretive language
  - advantage 1
- introduction 1
- ISPEXEC command of ISPF
  - using in a CLIST 138
- ISPF (Interactive System Productivity Facility)
  - availability
    - determining with &SYSISPF 37
  - command, in a CLIST 4, 94
  - copying a CLIST under ISPF 4
  - creating and editing a CLIST under ISPF 4
  - dialog
    - example 138
    - writing 137
  - executing a CLIST under ISPF 5
  - panel, using with a CLIST 137
  - restriction for a CLIST
    - length of variable 18
  - trapping TSO/E command output under ISPF 47
  - using ALTLIB under 7
- iterative DO sequence
  - using to create a loop 71

## J

- JCL (job control language)
  - including in a CLIST
    - example 125
    - precaution 12
  - protecting those containing /\* 125

- JCL (job control language) (*continued*)
  - special consideration for performing I/O on 99
- JES
  - finding level 37
  - finding name 37
  - finding network node name 38
- job
  - foreground and background execution
    - example 127
- jobcard information
  - verifying
    - example 125

## K

- keyboard 181
- keyword parameter
  - on PROC statement
    - description 20
    - example 127
    - prompting with 83

## L

- label 11, 152
- LASTCC 47
- LE (less than or equal to symbol) 14
- LENGTH 53
- length of a CLIST statement 11
- levels of searching
  - specifying with ALTLIB 7
- list of CLIST error codes 111
- list of sample CLISTS 117
- LISTALC command
  - managing command output 133
- LISTDSI statement
  - reason code 168
  - return code 168
  - sample CLIST 146
  - syntax 162
  - using to assign values to variables 49
  - variables set by 165
- LISTER CLIST 118
- LOG/LIST parameter
  - setting 137, 140
- logical operator 13
- LookAt message retrieval tool xiv
- loop, creating
  - using the compound DO sequence 72
  - using the DO-UNTIL-END sequence 71
  - using the DO-WHILE-END sequence 70
  - using the iterative DO sequence 71
- lowercase letter
  - converting from uppercase
    - with &SYSLC 59
  - converting to uppercase
    - with &SYSCAPS 59
    - with CONTROL CAPS 155
  - preserving
    - with &SYSASIS 44
    - with CONTROL NOCAPS 155

LT (less than symbol) 14

## M

MAIN operand of CONTROL

using to protect

global variable for attention routine 102

global variable for error routine 106

the input stack for attention routine 102

the input stack for error routine 106

managing command output

LISTALC command 133

MAXCC 48

message

controlling the display of

with &SYSMSG 44

with CONTROL MSG 87, 155

writing to the terminal

using WRITE and WRITENR 87

message retrieval tool, LookAt xiv

minus sign

as an arithmetic operator 13

as continuation symbol (hyphen) 10

MVS/DFP

finding the level installed 36

## N

NE (not equal sign) 14

nesting

CLIST

example 79

example - the SCRIPTN CLIST 122

protecting the input stack for nested CLISTS 44, 79

determining if CLISTS are nested 42

IF-THEN-ELSE Sequence 67

loop 73

nesting CLISTS

limitations with file i/o 95

variable 24

network node name

finding 38

NG (not greater than symbol) 14

NGLOBAL statement

syntax 170

using in a subprocedure 77

NL (not less than symbol) 14

NOCAPS

CONTROL statement operand 155

NOFLUSH operand of CONTROL

using to protect the input stack

for error routine 106

NOFLUSH option of CONTROL statement 155

Notices 183

NRSTR 54

null

ELSE format 67

line

coding for use with DATA PROMPT-

ENDDATA 85

null (*continued*)

line (*continued*)

issuing in an attention routine 103

THEN format 67

variable

creating 19

numeric value allowed in variable 15

## O

obtaining

current date and time 32

input from within a CLIST

using the DATA PROMPT-ENDDATA

sequence 85

offset of a string within a string

finding, with &SYSINDEX 60

OPENFILE statement 95

syntax 170

using 95

opening a file 95

operator

arithmetic 13

comparative 13

logical 13

option

including in a CLIST

example 128

using TESTDYN 127

OR

in the SELECT statement 175

logical operator 13

order of evaluation 14

organizing related activities 118

OUTPUT CLIST 122

output trapping

&SYSOUTLINE 46

&SYSOUTTRAP 46

example (the SPROC CLIST) 134

## P

panel, ISPF

displaying from a CLIST 2, 94

example 138

ISPF command in a CLIST 2

sample

XYZABC10 140

XYZABC20 140

XYZABC30 142

XYZABC40 144

parameter

defining on the PROC statement

keyword parameter 20, 172

positional parameter 20, 171

passing to a CLIST 6

parentheses

as arithmetic operator 13

defining as character data 56

passing control to the terminal

returning control after a TERMIN statement 93



- passing control to the terminal (*continued*)
  - TERMIN statement 92
- percent sign (%)
  - using in implicit execution of a CLIST 6
- performing file I/O
  - using &SYSDVAL 132
  - using READDVAL statement 132
- period
  - used to distinguish variable from data
    - example 23, 125
- PF key definition
  - setting 137
  - setting (1-12) 142
  - setting (13-24) 144
- PHONE CLIST 132
- plus sign
  - as an arithmetic operator 13
  - as continuation symbol 10
- position of a string within a string
  - finding, with &SYSINDEX 60
- positional parameter
  - on PROC statement
    - description 20
    - prompting with 83
- preserving double ampersands
  - with &NRSTR 54
- PROC statement
  - assigning value to variable with 20
  - defining parameter with 20
  - in a subprocedure 76
  - prompting with 83
  - syntax 171
- PROFILE CLIST 137, 138
- prompting for input 83
  - coding response to prompt
    - using DATA PROMPT-ENDDATA sequence 85
  - controlling uppercase and lowercase 90
  - example 120, 125
  - methods 83
  - permitting from a CLIST
    - using &SYSPROMPT 43
  - precaution when reading fully-qualified data set
    - name 89
  - returning control after a TERMIN statement 93
  - significance of &SYSDLM control variable after a
    - TERMIN statement 93
  - storing input in &SYSDVAL control variable 91
  - using statement
    - PROC 83
    - READ 88
    - READDVAL 91
    - TERMIN 92
    - WRITE 87
    - WRITENR 87
- protecting
  - input stack
    - for attention routine 102
    - for error routine 106
    - for nested CLISTs 79
    - using MAIN operand of CONTROL 102, 106
    - using NOFLUSH operand of CONTROL 106

- protecting (*continued*)
  - JCL statement containing /\*
    - example 125
- PUTFILE statement
  - syntax 172
  - using 97

## R

- RACF availability
  - determining with &SYSRACF 39
- READ statement
  - assigning value to variable with 19
  - defining variable with 19
  - syntax 173
  - using for prompting 88
- READDVAL statement
  - syntax 173
  - using when performing file I/O 132
- reading a record from a file 96
- reading input from the terminal
  - precaution when reading fully-qualified data set
    - name 89
  - storing input in &SYSDVAL control variable 91
  - to obtain value for PROC statement keyword 89
  - using the READ statement
    - controlling uppercase and lowercase 90
    - description 88
    - using the READDVAL statement 91
    - using the TERMIN statement
      - description 92
      - returning control after a TERMIN statement 93
      - significance of &SYSDLM control variable 93
    - using the TERMING statement
      - returning control after a TERMING statement 93
      - significance of &SYSDLM control variable 93
- reading input from within the CLIST
  - using the DATA PROMPT-ENDDATA sequence
    - example 86
- reason code
  - set by LISTDSI statement 168
- record
  - copying directly into variable using &SYSDVAL 132
  - performing file I/O consideration
    - concatenated data set 99
    - general 95
    - JCL statement 99
  - reading from a file 96
  - updating in a file 98
  - writing to a file 97
- retroactive variable
  - defining in a subprocedure
    - using SYSREF 77
- return code
  - from subprocedure 76
  - obtaining from a CLIST statement 111
  - set by LISTDSI statement 168
- RETURN statement
  - in a subprocedure 76
  - syntax 174

- routine
  - attention 101
  - error 105
- routine task
  - performing with CLIST 1
  - simplifying 118
- RUNPRICE CLIST 126

## S

- sample CLIST 132
  - adding
    - front-end prompting to the CALC CLIST 120
  - allowing
    - background execution of a CLIST 127
    - foreground execution of a CLIST 127
  - attention routine 103
  - background execution of a job 127
  - concatenating
    - data set to SYSPROC 134
  - creating
    - arithmetic expression from input 119
    - VIO data set 129
  - distinguishing
    - operator from an operand 128
    - variable from data 125
  - error routine 106
  - foreground execution of a job 127
  - full-screen application
    - writing 138
  - including
    - JCL statement 125
    - option 128
    - TSO/E command 118
  - initializing
    - system service 121
  - interface to application
    - simplifying 131
  - invoking
    - nested CLISTs to perform subtasks 122
    - system service 121
  - job card information
    - verifying 125
  - keyword
    - using to run foreground/background job 127
  - option
    - including 128
  - organizing
    - related activities 118
  - protecting
    - JCL statement containing /\* 125
    - leading zeros 125
  - READDVAL statement
    - using when performing file I/O 133
  - routine task
    - simplifying 118
  - simplifying
    - interface to application 131
    - routine task 118
    - system-related task 129

- sample CLIST (*continued*)
  - substringing
    - avoiding when performing file I/O 133
    - performing on input string 125
  - system-related task
    - simplifying 129
  - TSO/E command
    - including 118
  - using
    - keyword to run foreground/background job 127
  - verifying
    - job card information 125
  - VIO data set
    - creating 129
  - writing
    - full-screen application 138
- saving command output in a CLIST
  - example 133
- SCRIPTD CLIST 122
- SCRIPTDS CLIST 121
- SCRIPTNEST CLIST 122
- SELECT statement
  - distinguishing from the RACF SELECT
    - subcommand 69
    - syntax 174
    - using to make a selection 68
- selection menu
  - relevance to PROFILE CLIST 137
- self-contained application 2
- Session Manager
  - determining availability, with &SYSPROC 35
  - reformatting a screen with 34
- SET statement
  - assigning value to variable with 19
  - defining variable with 19
  - syntax 176
- setting
  - LOG/LIST parameter 137, 140
  - PF key definition 137
  - PF key definition (1-12) 142
  - PF key definition (13-24) 144
  - terminal characteristics 137, 140
- shift-in character, for DBCS string 15
- shift-out character, for DBCS string 15
- shortcut keys 181
- simple SELECT statement
  - syntax 174
- simplifying
  - interface to application 131
  - process of invoking CASHFLOW 131
  - routine task 118
  - system-related task 129
- SPROC CLIST 133
- standard format for IF-THEN-ELSE sequence 66
- STR 55
- string
  - performing substringing on input
    - example 125
- structuring a CLIST 65
  - branching within a CLIST
    - using GOTO statement 81

- structuring a CLIST (*continued*)
  - consideration 65
  - exiting
    - CLIST using the END command 81
    - CLIST using the EXIT statement 81
    - from a nested CLIST 80
  - global symbolic variables
    - establishing 80
    - example 80
  - IF-THEN-ELSE sequence
    - null THEN format 67
  - nesting CLISTs 79
    - example 79
  - subprocedure 75
  - using a DO-group
    - consideration 70
    - distinguishing END statement from subcommand 74
    - the DO-END sequence 66
  - using SELECT statement
    - distinguishing a WHEN clause from a command 69
    - distinguishing END statement from subcommand 74
  - using the compound DO sequence 72
  - using the DO statement
    - nesting DO-loops 73
  - using the DO-UNTIL-END sequence 71
  - using the DO-WHILE-END sequence 70
    - example 70
  - using the IF-THEN-ELSE sequence
    - condition 66
    - nesting IF-THEN-ELSE 67
    - null ELSE format 67
    - null THEN format 67
    - standard format 66
  - using the iterative DO sequence 71
  - using the SELECT statement 68
    - with a test expression 68
    - without a test expression 68
- subcommand
  - environment
    - effect on nested CLISTs 80
  - of the EDIT command
    - executing a CLIST with 5
    - using to modify a CLIST 4
  - of the TEST command
    - executing a CLIST with 5
- SUBMIT \* command
  - example 125
- SUBMITDS CLIST 125
- SUBMITFQ CLIST 125
- subprocedure
  - calling, using SYSCALL 75
  - defining with the PROC statement 76
  - passing control to 75
  - returning information from
    - retroactive (SYSREF) variable 77
    - return code 76
  - sharing variables among
    - using the NGLOBAL statement 77
- subprocedure (*continued*)
  - using SYSREF in 77
- substitution, symbolic
  - See symbolic substitution
- SUBSTR 57
- substringing
  - avoiding when performing file I/O 132
  - on input string
    - example 125
- subtask
  - performing using nested CLISTs 122
    - OUTPUT 122
    - SCRIPTD 122
- symbol
  - continuation 10
- symbolic substitution
  - limiting
    - with &NRSTR 54
    - with &SYSCAN 42
    - with &SYSNSUB 62
  - of nested variables 25
  - of variable 17
- symbolic variable
  - assigning value to 17
  - naming 18
  - value of 18
- syntax
  - ATTN statement 152
  - CLOSFILE statement 153
  - CONTROL statement 154
  - DATA PROMPT-ENDDATA sequence 156
  - DATA-ENDDATA sequence 156
  - DO statement 156
  - END statement 158
  - ERROR statement 158
  - EXIT statement 159
  - GETFILE statement 160
  - GLOBAL statement 160
  - GOTO statement 161
  - IF-THEN-ELSE sequence 162
  - LISTDSI statement 162
  - NGLOBAL statement 170
  - OPENFILE statement 170
  - PROC statement 171
  - PUTFILE statement 172
  - READ statement 173
  - READDVAL statement 173
  - RETURN statement 174
  - SELECT statement 174
  - SET statement 176
  - SYSCALL statement 176
  - SYSREF statement 177
  - TERMIN statement 178
  - TERMING statement 178
  - WRITE statement 179
  - WRITENR statement 179
- syntax diagram 149
- syntax rule 9
  - CLIST
    - capitalization 10
    - comment 11



TSO/E (*continued*)  
 finding MVS system symbol 35  
 finding MVS/DFP level 36  
 finding security level 40  
 finding terminal ID 34  
 TSO/E commands  
 prompting for input with 84  
 trapping output from  
 description 46  
 example 134  
 using in a CLIST 2, 12  
 TSO/E service facility  
 using to execute a CLIST from another language 6  
 TSOEXEC command 49

## U

understanding CLIST error code 111  
 updating a file 98  
 uppercase letter  
 converting from lowercase  
 with &SYSCAPS 59  
 with CONTROL CAPS 155  
 converting to lowercase  
 with &SYSLC 59

## V

variable  
 assigning value  
 description 17  
 combining  
 containing DBCS data set 25  
 symbolic and character strings 23  
 control  
 &LASTCC 47  
 &MAXCC 48  
 &SYS4DATE 33  
 &SYS4SDATE 33  
 &SYSAPPCLU 37  
 &SYSASIS 44  
 &SYSCLONE 35  
 &SYSCONLIST 43  
 &SYSCPU 36  
 &SYSDATE 32  
 &SYSDFP 36  
 &SYSDLM 45  
 &SYSDVAL 45  
 &SYSENV 41  
 &SYSFLUSH 44  
 &SYSICMD 42  
 &SYSISPF 37  
 &SYSJDATE 32  
 &SYSJES 37  
 &SYSLIST 43  
 &SYSLRACF 37  
 &SYSLTERM 34  
 &SYSMSG 44  
 &SYSMVS 38  
 &SYSNAME 38  
 &SYSNEST 42

variable (*continued*)  
 control (*continued*)  
 &SYSNODE 38  
 &SYSOPSYS 39  
 &SYSOUTLINE 46  
 &SYSOUTTRAP 46  
 &SYSPCMD 42  
 &SYSPLEX 39  
 &SYSPREF 34  
 &SYSPROC 35  
 &SYSPROMPT 43  
 &SYSRACF 39  
 &SYSSCAN 42  
 &SYSSCMD 42  
 &SYSSDATE 32  
 &SYSSECLAB 40  
 &SYSSMFID 40  
 &SYSSMS 40  
 &SYSSRV 36  
 &SYSSTIME 33  
 &SYSSYMDEF 40  
 &SYSSYMLIST 43  
 &SYSTEMID 34  
 &SYSTIME 33  
 &SYSTSOE 41  
 &SYSUID 34  
 &SYSWTERM 34  
 consideration for &SYSDATE and  
 &SYSSDATE 32, 33  
 describing terminal characteristics 33  
 description 28  
 for TSO/E command output trapping 46  
 i&SYS4JDATE 33  
 in an iterative DO loop 71  
 modifiable 30  
 non-modifiable 30  
 related to input 45  
 related to return and reason codes 47  
 related to the CLIST 41  
 related to the CLIST CONTROL statement 42  
 related to the current date and time 32  
 related to the system 35  
 related to the user 34  
 related to TSOEXEC command 49  
 relationship between &SYSPCMD and  
 &SYSSCMD 42  
 defining symbolic variable 19  
 GLOBAL 80  
 LISTDSI statement 165  
 naming  
 description 18  
 on PROC statement 18  
 nesting 24  
 NGLOBAL 77  
 related to the TSOEXEC command  
 &SYSABNCD 49  
 &SYSABNRC 49  
 set by LISTDSI statement 165  
 subprocedure variable 78  
 symbolic substitution of 17, 25  
 using double ampersands with 24

variable (*continued*)  
value of 18  
VIO data set  
creating 129

## W

WHEN clause of SELECT statement  
distinguishing from the WHEN command 69  
WRITE statement  
prompting with 19, 84  
syntax 179  
WRITENR statement  
prompting with 84  
syntax 179  
writing  
full-screen application 137  
message to the terminal 87  
record to a file 97

## Y

year formats, four-digit years  
*See also* SYS4DATE  
*See also* SYS4JDATE  
*See* SYS4SDATE  
year formats, two-digit years  
*See also* SYSDATE  
*See also* SYSJDATE  
*See* SYSSDATE

## Z

z/OS name, version, and so on  
finding 39

---

# Readers' Comments — We'd Like to Hear from You

z/OS  
TSO/E CLISTS

Publication No. SA22-7781-02

Overall, how satisfied are you with the information in this book?

|                      | Very Satisfied           | Satisfied                | Neutral                  | Dissatisfied             | Very Dissatisfied        |
|----------------------|--------------------------|--------------------------|--------------------------|--------------------------|--------------------------|
| Overall satisfaction | <input type="checkbox"/> | <input type="checkbox"/> | <input type="checkbox"/> | <input type="checkbox"/> | <input type="checkbox"/> |

How satisfied are you that the information in this book is:

|                          | Very Satisfied           | Satisfied                | Neutral                  | Dissatisfied             | Very Dissatisfied        |
|--------------------------|--------------------------|--------------------------|--------------------------|--------------------------|--------------------------|
| Accurate                 | <input type="checkbox"/> | <input type="checkbox"/> | <input type="checkbox"/> | <input type="checkbox"/> | <input type="checkbox"/> |
| Complete                 | <input type="checkbox"/> | <input type="checkbox"/> | <input type="checkbox"/> | <input type="checkbox"/> | <input type="checkbox"/> |
| Easy to find             | <input type="checkbox"/> | <input type="checkbox"/> | <input type="checkbox"/> | <input type="checkbox"/> | <input type="checkbox"/> |
| Easy to understand       | <input type="checkbox"/> | <input type="checkbox"/> | <input type="checkbox"/> | <input type="checkbox"/> | <input type="checkbox"/> |
| Well organized           | <input type="checkbox"/> | <input type="checkbox"/> | <input type="checkbox"/> | <input type="checkbox"/> | <input type="checkbox"/> |
| Applicable to your tasks | <input type="checkbox"/> | <input type="checkbox"/> | <input type="checkbox"/> | <input type="checkbox"/> | <input type="checkbox"/> |

Please tell us how we can improve this book:

Thank you for your responses. May we contact you?  Yes  No

When you send comments to IBM, you grant IBM a nonexclusive right to use or distribute your comments in any way it believes appropriate without incurring any obligation to you.

\_\_\_\_\_  
Name

\_\_\_\_\_  
Address

\_\_\_\_\_  
Company or Organization

\_\_\_\_\_  
Phone No.



Fold and Tape

Please do not staple

Fold and Tape



NO POSTAGE  
NECESSARY  
IF MAILED IN THE  
UNITED STATES

# BUSINESS REPLY MAIL

FIRST-CLASS MAIL PERMIT NO. 40 ARMONK, NEW YORK

POSTAGE WILL BE PAID BY ADDRESSEE

IBM Corporation  
Department 55JA, Mail Station P384  
2455 South Road  
Poughkeepsie, NY  
12601-5400



Fold and Tape

Please do not staple

Fold and Tape







Program Number: 5694-A01 and 5655-G52

Printed in U.S.A.

SA22-7781-02

